

33:

W1.33.

# FM 23-55

WAR DEPARTMENT FIELD MANUAL

---

## **BROWNING MACHINE GUNS, CALIBER .30, M1917A1, M1919A4, AND M1919A6**

---

WAR DEPARTMENT • JULY 1945

W1.33

FIELD MANUAL

BROWNING MACHINE GUNS, CALIBER .30, M1917A1, M1919A4, AND M1919A6

CHANGES  
No. 1.

WAR DEPARTMENT  
WASHINGTON 25, D. C., 30 September 1946

FM 23-55, 30 July 1945, is changed as follows:

III. MARKSMANSHIP COURSES.

\* \* \* \* \*

b. **Course A** (Superseded). Instruction practice consists of firing tables I and II at least once. The instruction and record practice prescribed in table I may be completed prior to commencing instruction and record practice in table II. With the M1919A6 machine gun, table I is fired from the tripod, and table II from the bipod.

Table I<sup>1</sup>

Range (inches)	Time (seconds)	Total shots	Target	Type of fire
1,000-----	45 <sup>2</sup> -----	48	1,000-inch heavy machine-gun target. (Pasters 5 to 6 or 9 to 10.)	Combined, one exercise, 48 rounds. One burst each scoring space.
1,000-----	35 <sup>3</sup> -----	30	1,000-inch heavy machine-gun target. (Pasters 7 to 8 or 8 to 7.)	Searching, one exercise, 30 rounds. One burst each scoring space.

<sup>1</sup> Prior to firing this table for instruction and record practice, the firer will be permitted one adjustment burst of six rounds at one of the fixed scoring spaces. There will be no time limit for adjustment firing and the burst will not be scored. In firing this table, the soldier must not know which type of exercise he will fire until he takes his position at the gun. The officer in charge will inform the individual of the exercises to be fired. The searching exercise will be fired in the lateral direction opposite to that in which the combined traversing and searching exercise is fired.

<sup>2</sup> Fifty seconds for light machine guns.  
<sup>3</sup> Forty seconds for light machine guns

Table II

Range (yards)	Time	Total shots	Target	Type of fire
400 to 800--	4 min-----	120	8 double "E" silhouette targets.	Fixed. One exercise, 120 rounds.

c. **Course B** (Superseded). With all guns on the tripod mount, instruction practice consists of firing tables III and IV once. Record practice consists of firing table IV once. Following record practice with the tripod, the M1919A6 machine gun is fired from the bipod for familiarization.

12 252SU  
07/06 XL 2364  
31150-198  
Digitized by Google

Table III

Range (inches)	Time (seconds)	Total shots	Target	Type of fire
1,000-----	No limit----	12	1,000-inch machine-gun target.	Zeroing allowance per man during instruction practice.
1,000-----	No limit----	24	1,000-inch machine-gun target.	FIXED (4 exercises, 6 rounds each).
1,000-----	No limit----	30	1,000-inch machine-gun target.	SEARCHING (1 exercise, 30 rounds).
1,000-----	No limit----	96	1,000-inch machine-gun target.	COMBINED (2 exercises, 48 rounds each).
1,000-----	No limit----	150	1,000-inch machine-gun target.	FIXED, SEARCHING, and COMBINED (7 separate exercises, 150 rounds).

Table IV

Range (inches)	Time (seconds)	Total shots	Target	Type of fire
1,000-----	No limit----	12	1,000-inch machine-gun target.	Zeroing allowance per man during record practice.
1,000-----	12 (each exercise).	24	1,000-inch machine-gun target. (Pasters 1, 2, 3, and 4.)	FIXED, 4 separate exercises, 6 rounds each. One burst each scoring space.
1,000-----	35 <sup>1</sup> -----	30	1,000-inch machine-gun target. (Pasters 7 to 8.)	SEARCHING, 1 exercise, 30 rounds. One burst each scoring space.
1,000-----	45 <sup>2</sup> (each exercise).	96	1,000-inch machine-gun target. (Pasters 5 to 6 and 9 to 10.)	COMBINED, 2 exercises, 48 rounds each. One burst each scoring space.

<sup>1</sup> Forty seconds for light machine guns.

<sup>2</sup> Fifty seconds for light machine guns.

[AG 300.7 (19 Sep 46)]

BY ORDER OF THE SECRETARY OF WAR:

OFFICIAL:

EDWARD F. WITSELL  
Major General  
The Adjutant General

DWIGHT D. EISENHOWER  
Chief of Staff

DISTRIBUTION:

AAF (10); AGF (40); T (2); Def Comd (2); Arm & Sv Bd (1); Tech Sv (2); HD (2); FC (1); Gen & Sp Sv Sch (50), except 7 (8500); USMA (50); ROTC (1); A (10); CHQ (10); D (3); B (2); R 2, 5, 7, 17, 18 (2); Bn 2, 5, 7, 17, 18 (2); C 2, 5, 7, 17, 18 (5), 9 (2); T/O & E: 6-160-1 (5); 6-165 (2); 6-166 (5); 6-167 (5); 6-169 (5); 9-65 (2); 9-66 (5); 9-67 (5); 10-35 (2); 10-36 (5); 10-37 (5); 11-57 (5); 11-488 (5); 11-488S (5); 44-75 (2); 44-76 (5); 44-77 (5).

For explanation of distribution formula, see FM 21-6.

WAR DEPARTMENT FIELD MANUAL  
FM 23-55

*This manual supersedes FM 23-55, 20 June 1940, including C 1, 25 July 1941, C 2, 6 May 1942, C 3, 24 July 1942, C 4, 1 May 1944; FM 23-45, 12 April 1943, including C 1, 22 April 1943, C 2, 25 March 1944; FM 23-50, 12 August 1942, including C 1, 12 October 1942, C 2, 1 March 1943, C 3, 23 April 1943, C 4, 29 April 1944; TM 9-206, 1 September 1943, including C 1, 7 November 1943; section II, Training Circular No. 61, War Department 26 September 1944; and Training Circular No. 6, War Department, 8 February 1945.*

---

BROWNING MACHINE GUNS,  
CALIBER .30, M1917A1,  
M1919A4, and M1919A6



WAR DEPARTMENT • JULY 1945

---

United States Government Printing Office  
Washington : 1945

---

For sale by the Superintendent of Documents, U. S. Government Printing Office  
Washington 25, D. C. - 50 cents



WAR DEPARTMENT  
WASHINGTON 25, D. C., 30 July 1945.

FM 23-55, Browning Machine Guns, Caliber .30, M1917A1, M1919A4, and M1919A6, is published for the information and guidance of all concerned.

[AG 300.7 (16 Apr 45)]

BY ORDER OF THE SECRETARY OF WAR:

OFFICIAL:

J. A. ULIO  
*Major General*  
*The Adjutant General*

G. C. MARSHALL  
*Chief of Staff*

DISTRIBUTION:

AAF (10); AGF (40); ASF (2); T of Opns (2); Arm & Sv Bd (1); Def Comd (2); Tech Sv (2); SvC (10); HD (2); PC&S (1); Gen & Sp Sv Sch (50) except Inf Sch (8,500); USMA (50); ROTC (1); A (10); CHQ (10); D (3); B (2); R 2, 5, 7, 17, 18 (2); Bn 2, 5, 7, 17, 18 (2); C 2, 5, 7, 17, 18 (5); 9 (2). T/O & E: 6-160-1 (5); 6-165 (2); 6-166 (5); 6-167 (5); 6-169 (5); 9-65 (2); 9-66 (5); 9-67 (5); 10-35 (2); 10-36 (5); 10-37 (5); 11-57 (5); 11-488 (5); 11-488S (5); 44-75 (2); 44-76 (5); 44-77 (5).

Refer to FM 21-6 for explanation of distribution formula.

## CONTENTS

	<i>Paragraphs</i>	<i>Page</i>
<b>CHAPTER 1. MECHANICAL TRAINING.</b>		
<i>Section I.</i> Descriptions .....	1-5	1
II. Disassembling, assembling and changing parts.....	6-19	7
III. Care and cleaning .....	20-30	29
IV. Mechanical functioning .....	31-33	36
V. Stoppages and immediate action .....	34-37	45
VI. Mounts .....	38-43	50
 <b>CHAPTER 2. TRAINING FOR PLACING MACHINE GUNS IN ACTION.</b>		
<i>Section I.</i> General .....	44-45	57
II. Gun drill with M1917A1 machine gun .....	46-54	58
III. Gun drill with M1919A4 machine gun .....	55-62	79
IV. Gun drill with M1919A6 machine gun .....	63-69	90
V. Measuring and laying off angles .....	70-81	97
VI. Battery drill .....	82-92	103
 <b>CHAPTER 3. MARKSMANSHIP.</b>		
<i>Section I.</i> General .....	93-96	109
II. Preparatory exercises .....	97-109	110
III. Range practice .....	110-111	126
IV. Conduct of range practice .....	112-120	128
V. Safety precautions .....	121-122	142
 <b>CHAPTER 4. MARKSMANSHIP FOR MOVING GROUND TARGETS.</b>		
123-127	143	
 <b>CHAPTER 5. MARKSMANSHIP FOR AERIAL TARGETS.</b>		
<i>Section I.</i> Antiaircraft gunnery .....	128-131	147
II. Preliminary training .....	132-138	151
III. Advanced training: towed-target and radio-controlled plane-target firing .....	139-151	156
 <b>CHAPTER 6. TECHNIQUE OF FIRE: DIRECT LAYING.</b>		
<i>Section I.</i> General .....	152-153	163
II. Characteristics of fire .....	154-157	163
III. Classes of fire .....	158-161	167
IV. Range determination and windage .....	162-168	170
V. Elements of fire orders .....	169-170	171
VI. Target designation .....	171-172	172
VII. Fire distribution .....	173-178	174
VIII. Fire control .....	179-181	181
IX. Auxiliary aiming point .....	182	183
X. Fire orders .....	183-184	185
XI. Overhead fire .....	185-186	191
XII. Final protective lines .....	187-193	196
XIII. Range cards .....	194	200
XIV. Direct laying on landscape targets at 1,000 inches...	195-201	202

# CONTENTS

	<i>Paragraphs</i>	<i>Page</i>
<b>CHAPTER 7. TECHNIQUE OF FIRE: POSITION DEFILADE.</b>		
<i>Section I.</i> Firing positions .....	202-203	204
<i>II.</i> Firing .....	204-208	206
<i>III.</i> Fire orders and new targets .....	209-210	213
<b>CHAPTER 8. TECHNIQUE OF FIRE: INDIRECT LAYING.</b>		
<i>Section I.</i> General .....	211-212	214
<i>II.</i> Theory of indirect laying .....	213	217
<i>III.</i> Solving an indirect laying problem .....	214-216	220
<b>CHAPTER 9. ARMORED APPLICATION (M1919A4 MACHINE GUN).</b>		
<i>Section I.</i> Mounts and mount adjustment .....	217-219	237
<i>II.</i> Sights and sight adjustment .....	220-221	238
<i>III.</i> Placing guns in action .....	222	238
<i>IV.</i> Marksmanship training .....	223-227	238
<b>APPENDIX I. ACCESSORIES .....</b>		248
<b>II. CONSTRUCTION OF WOODEN WORKING MODEL.....</b>		259
<b>III. FIRING AT FIELD TARGETS.....</b>		267
<b>IV. INFANTRY PLOTTING BOARD M10.....</b>		270
<b>V. COMPUTATION OF FIRING DATA.....</b>		276
<b>VI. DESTRUCTION OF ORDNANCE MATERIEL IN EVENT         OF IMMINENT CAPTURE.....</b>		288
<b>INDEX .....</b>		291

*This manual supersedes FM 23-55, 20 June 1940, including C 1, 25 July 1941, C 2, 6 May 1942, C 3, 24 July 1942, C 4, 1 May 1944; FM 23-45, 12 April 1943, including C 1, 22 April 1943, C 2, 25 March 1944; FM 23-50, 12 August 1942, including C 1, 12 October 1942, C 2, 1 March 1943, C 3, 23 April 1943, C 4, 29 April 1944; TM 9-206, 1 September 1943, including C 1, 7 November 1943; section II, Training Circular No. 61, War Department 26 September 1944; and Training Circular No. 6, War Department, 8 February 1945.*

## CHAPTER 1

### MECHANICAL TRAINING

---

#### Section I. DESCRIPTIONS

##### 1. Browning Machine Gun, Caliber .30, M1917A1

a. **PRINCIPLE OF OPERATION.** The M1917A1 machine gun (fig. 1) is recoil operated, belt fed, and water cooled. In recoil operation, the rearward force of the expanding powder gas (kick) furnishes the operating energy.

b. **GENERAL DATA.**

Weight of gun and pintle, without water (pounds)...	32.60
Weight of gun and pintle, with water (pounds).....	41.00
Length of barrel (inches).....	23.90
Sight graduation (yards) .....	2,600
Weight of tripod, M1917A1 (pounds).....	53.20
Cyclic rate of fire (rounds per minute).....	450-600

c. **COOLING SYSTEM.** The barrel is surrounded by a water jacket which holds about 7 pints of water. The water prevents the barrel from becoming overheated. Since the heat of prolonged firing generates steam in the water jacket, a steam tube assembly is provided to permit the steam to escape. This assembly extends the length of the water jacket and is located inside at the top. It consists of two tubes, one within the other;

---

For military terms not defined in this manual, see TM 20-205; for list of training publications, see FM 21-6; for training films, film strips, and film bulletins, see FM 21-7; and for training aids, see FM 21-8.

Unless otherwise stated, any statement contained in this manual is applicable to all three guns. For convenience, the M1917A1 machine gun is frequently referred to throughout the manual as the "heavy" machine gun; the M1919A4 and M1919A6 guns are similarly referred to as "light" machine guns. Material concerning the M1919A4 machine gun applies also to the M1919A6 gun when the latter is mounted on the M-2 tripod, unless otherwise stated. Therefore, when reference is made to the M1919A4 and M1919A6 guns or "light" guns, it is to be understood that both guns are mounted on the M-2 tripod for the operation under discussion. When the M1919A6 gun is mounted on the bipod, the fact will be parenthetically stated.

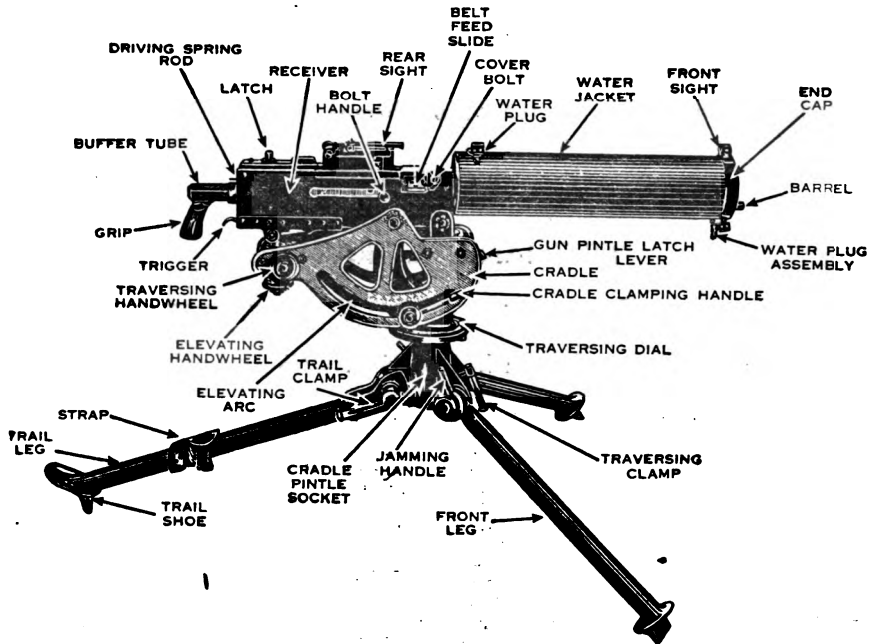


Figure 1. Browning machine gun, caliber .30, M1917A1.

the shorter, outer tube slides freely over the inner tube. On the top side and at each end of the inner tube is a hole. Since the outer tube is shorter than the distance between these two holes, it cannot cover both holes at the same time. Therefore, as the muzzle is elevated or depressed, gravity causes the outer tube to slide down and cover the lower hole, thus preventing water from flowing into the assembly. Correspondingly, the upper hole is uncovered, allowing the steam to pass from the water jacket through the inner tube. The steam then passes through a small tube to the steam condensing device, the opposite end of which is immersed in the water chest.

*d.* **FRONT SIGHT.** The front sight consists of the front sight blade and the front sight base. The blade is dovetailed into the base to permit lateral adjustment and is held in place by the front sight bladescrew. The base screws fasten the base to the end cap. They are screwed in place and then filed flush with the base. The base is also sweated on with solder.

*e.* **REAR SIGHT.** (1) The rear sight (fig. 2) is adjustable for windage and deflection. Compensation for drift is set off automatically by the construction of the rear sight leaf.

(2) The leaf and slide assembly is mounted on the movable base, which, in turn, is pivoted on the fixed base, the latter being riveted to the

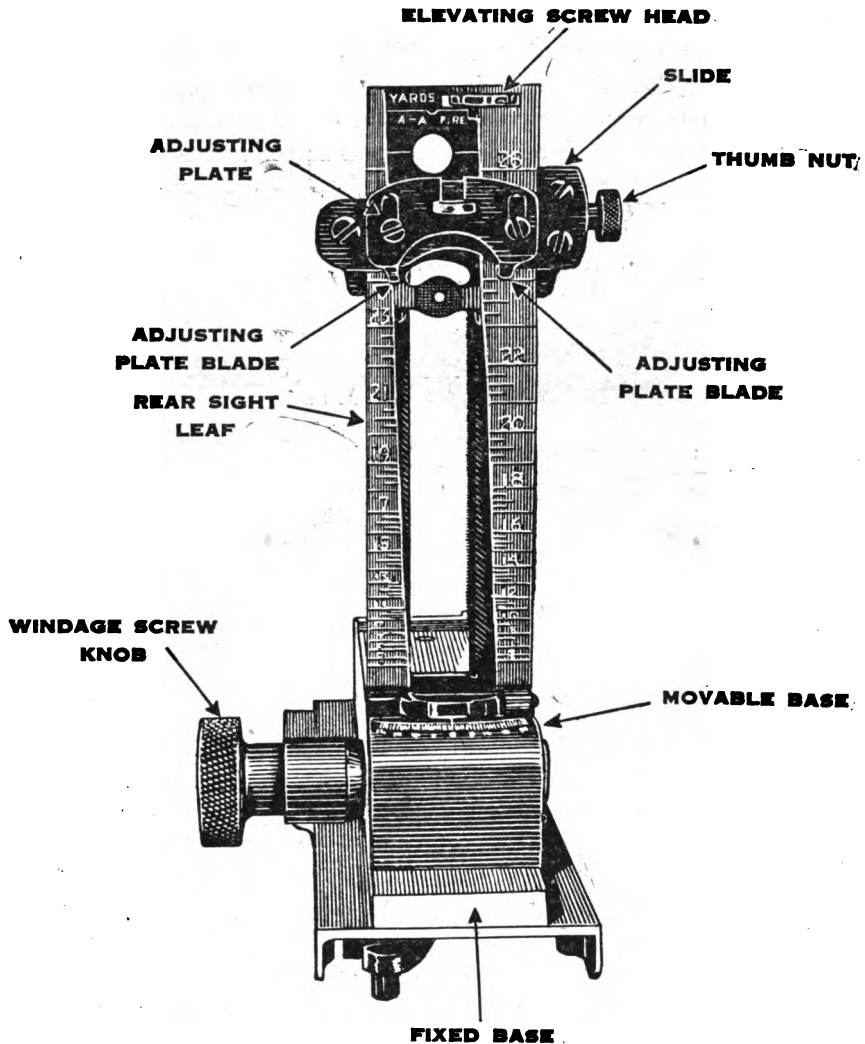


Figure 2. Sight for the M1917A1 gun.

cover. The windage screw assembly is seated on the fixed base, and by turning the windage screw, the movable base with its assembled parts revolves about its pivot. This provides a mechanical means for making allowances for the force of the wind. It also provides a means for measuring and laying off small horizontal angles and setting the sights at zero deflection.

(3) The rear sight leaf is graduated in yards. The windage arc is graduated in mils. (A mil is  $\frac{1}{6400}$  of a circle.)

## 2. Browning Machine Gun, Caliber .30, M1919A4

a. **PRINCIPLE OF OPERATION.** The M1919A4 machine gun (fig. 3) is recoil operated, belt fed, and air cooled. This gun is equipped with a front barrel plug which, by trapping some of the gas near the muzzle, insures the positive recoil of the barrel and barrel extension.

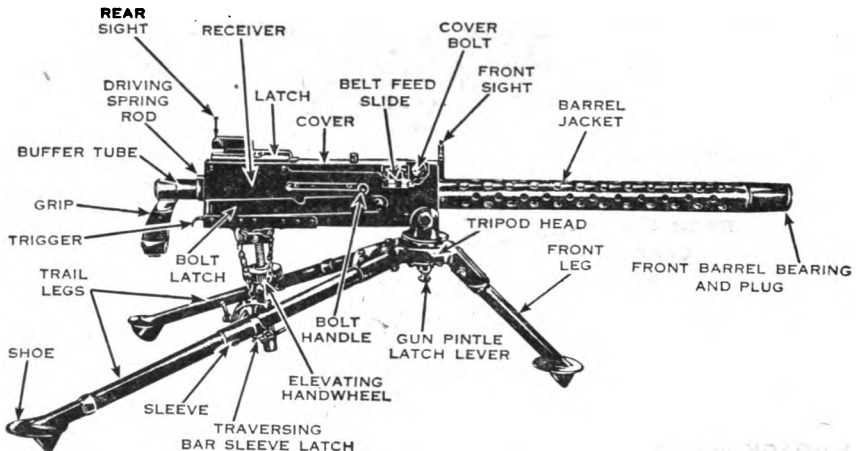


Figure 3. Browning machine gun, caliber .30, M1919A4.

### b. GENERAL DATA.

Weight of gun (pounds).....	31.00
Weight of barrel (pounds).....	7.35
Weight of pintle and combined elevating and traversing mechanism (pounds) .....	4.75
Weight of tripod mount, M2 (pounds).....	14.00
Length of barrel (inches).....	24.00
Sight graduation (yards).....	2400.
Cyclic rate of fire (rounds per minute).....	400-550

c. **COOLING SYSTEM.** The M1919A4 machine gun is provided with a heavy barrel. This barrel, which is slower to heat up than the lighter barrel of the M1917A1 gun, presents a larger surface to the air. The air circulating between the barrel and the barrel jacket carries off some of the heat generated by firing.

d. **FRONT SIGHT.** The front sight (fig. 4①) consists of a front sight blade, a front sight post, bracket body, and a plunger mechanism. The front sight post pivots on the front bearing screw when folded. The plunger mechanism provides a locking device to keep the front sight post in its upright position when the gun is being fired.

e. **REAR SIGHT.** (1) The rear sight (fig. 4②) is assembled to the rear sight base and is adjustable for windage. The rear sight base is secured

to the left side plate of the receiver by three rivets in the flange of the base.

(2) The rear sight leaf is graduated for elevation in 100-yard divisions up to 2,400 yards. Motion of the rear sight slide is accomplished by rota-

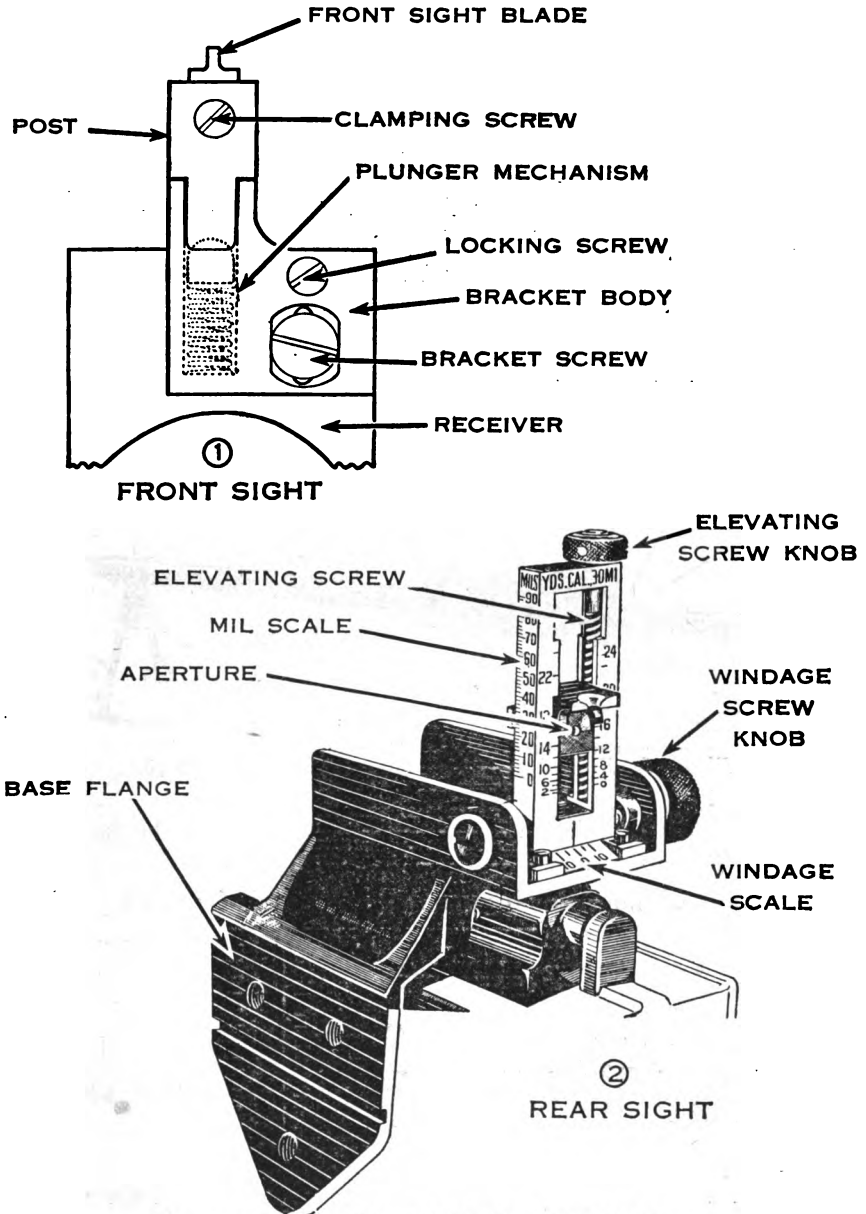


Figure 4. Sights of the M1919A4 and M1919A6 gun.



tion of the elevation screw knob. This elevating screw mechanism is equipped with a mil click device which may be used in conjunction with the mil scale engraved on the left side of the rear sight leaf to measure or establish angles of elevation in mils. (See pars. 77 and 78.)

(3) The windage screw mechanism also incorporates a mil click device. Adjustment of the rear sight leaf in windage is accomplished by rotation of the windage screw knob. The windage gauge of the M1919A4 machine gun is marked in 5-mil graduations for 10 mils right or left from zero.

### 3. Browning Machine Gun, Caliber .30, M1919A6

*a.* PRINCIPLE OF OPERATION. The M1919A6 machine gun (fig. 5) operates in the same manner as the M1919A4 gun. (See par. 2*a.*) A booster cap is furnished with the M1919A6 gun to speed up the cyclic rate. It is affixed to the front barrel bearing by means of a detachable retaining clip. This booster cap traps some of the gas in the barrel which acts to insure positive recoil action when the gun is fired at angles other than the usual horizontal.

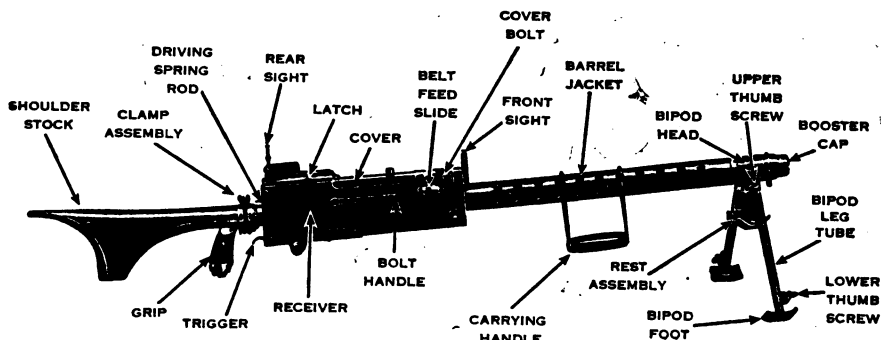


Figure 5. Browning machine gun, caliber .30, M1919A6.

*b.* GENERAL DATA. With the exception of the following, the data listed in paragraph 2*b, c, d,* and *e* applies to the M1919A6 gun.

Weight of gun with bipod and shoulder stock (pounds) ..	32.50
Weight of barrel (pounds) .....	4.65
Weight of shoulder stock (pounds) .....	1.75

### 4. Ammunition Belt

The ammunition belt is made of woven fabric with loops, and with a metal strip at each end to facilitate loading. Some belts have a metal strip at one end only.

### 5. Mountings

See section VI of this chapter for a detailed description of the various mountings.

### 6.

## Section II. DISASSEMBLING, ASSEMBLING, AND CHANGING PARTS

### 6. General

a. Disassembling may be considered under two general headings: removal of the groups to the extent required for ordinary cleaning and minor repairs, and detailed disassembling, involving removal of all component parts of each group.

b. A group is a number of parts, contained in a common housing, which function as a unit.

c. The removal of the different groups from the gun and the complete disassembling of the groups authorized to be disassembled by the using services can be accomplished with the tools provided.

d. To prevent damage to the rear sight of the M1917A1 gun, the sight leaf must be raised before raising the cover. The cover is raised by gripping the rear sight base and not the sight leaf, windage screw knob, or rear sight thumb nut.

e. To prevent damage to the front sight of the M1919A4 and M1919A6 guns, the front sight post, if it is in the lowered position, must be raised before raising the cover.

### 7. Removal of Groups from Gun (fig. 6① and ②)

a. **BACKPLATE.** (1) Pull back on the latch and raise the cover. With the left hand, pull back on the bolt handle and hold it in the rearmost position.

(2) With the right hand, insert the rim of a cartridge or the screw driver end of the combination tool, in the slit in the end of the driving spring rod. With the slit horizontal, push in the driving spring rod as far as it will go and turn it clockwise one-quarter turn until the slit is vertical. In this position, the driving spring rod pin will engage in its recess in the bolt and the driving spring is held compressed within the bolt.

(3) Push the bolt handle forward 1 inch to free the rear end of the driving spring rod from the backplate. Push the latch forward and lift out the backplate.

b. **BOLT HANDLE AND BOLT.** Pull the bolt all the way back and remove the bolt handle. Remove the bolt.

c. **LOCK FRAME.** Insert the nose of a cartridge through the hole in the right side of the receiver and push in on the trigger pin. Grasp the trigger and pull the lock frame, barrel extension, and barrel from the receiver. If resistance is met, pull on spacer to avoid damage to trigger. Hold the barrel in one hand and the lock frame in the other; trip the accelerator and separate the lock frame from the barrel extension.

d. **BARREL EXTENSION AND BARREL.** Unscrew the barrel and barrel extension from each other.

e. **LATCH.** Pull the latch to the rear until it separates from the top plate.

f. **COVER.** (1) Remove the cotter pin from the cover bolt. Place the screw driver end of the combination tool in the slit in the cover bolt to prevent the bolt from turning, then unscrew the nut.

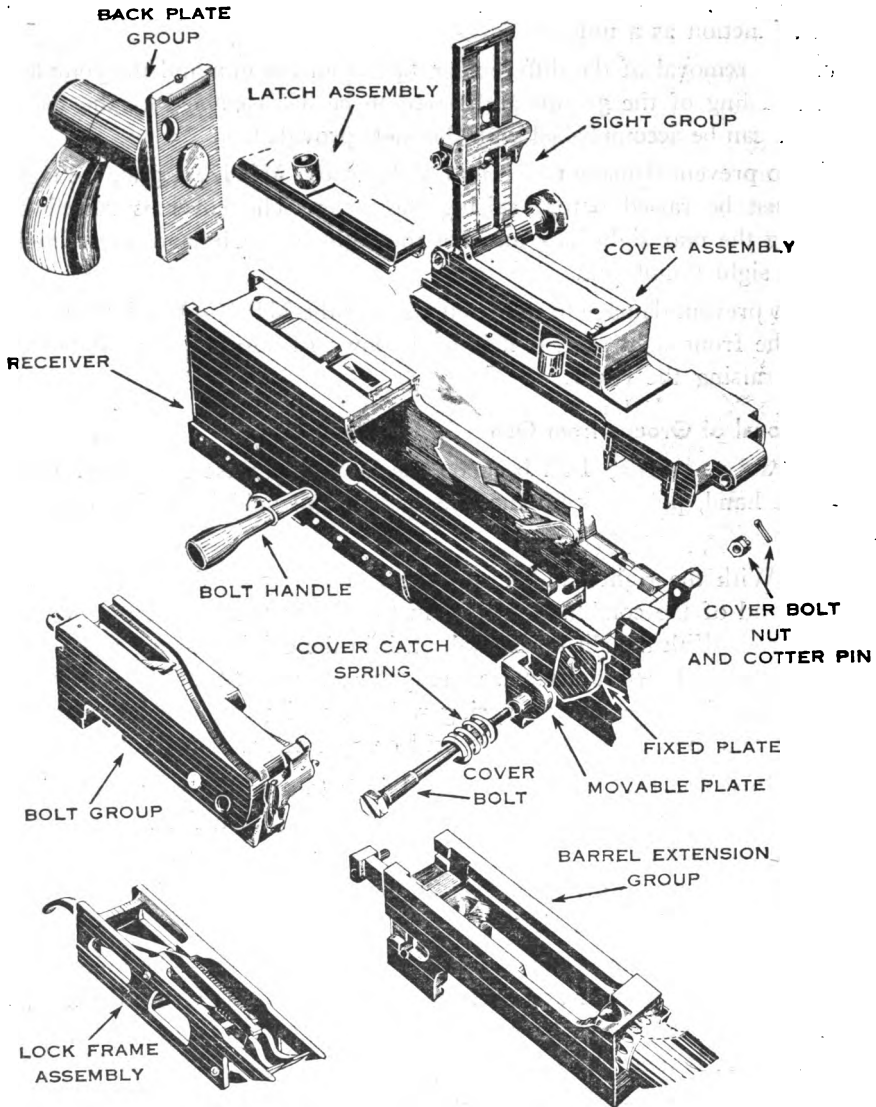


Figure 6①. Groups of the M1917A1 machine gun.

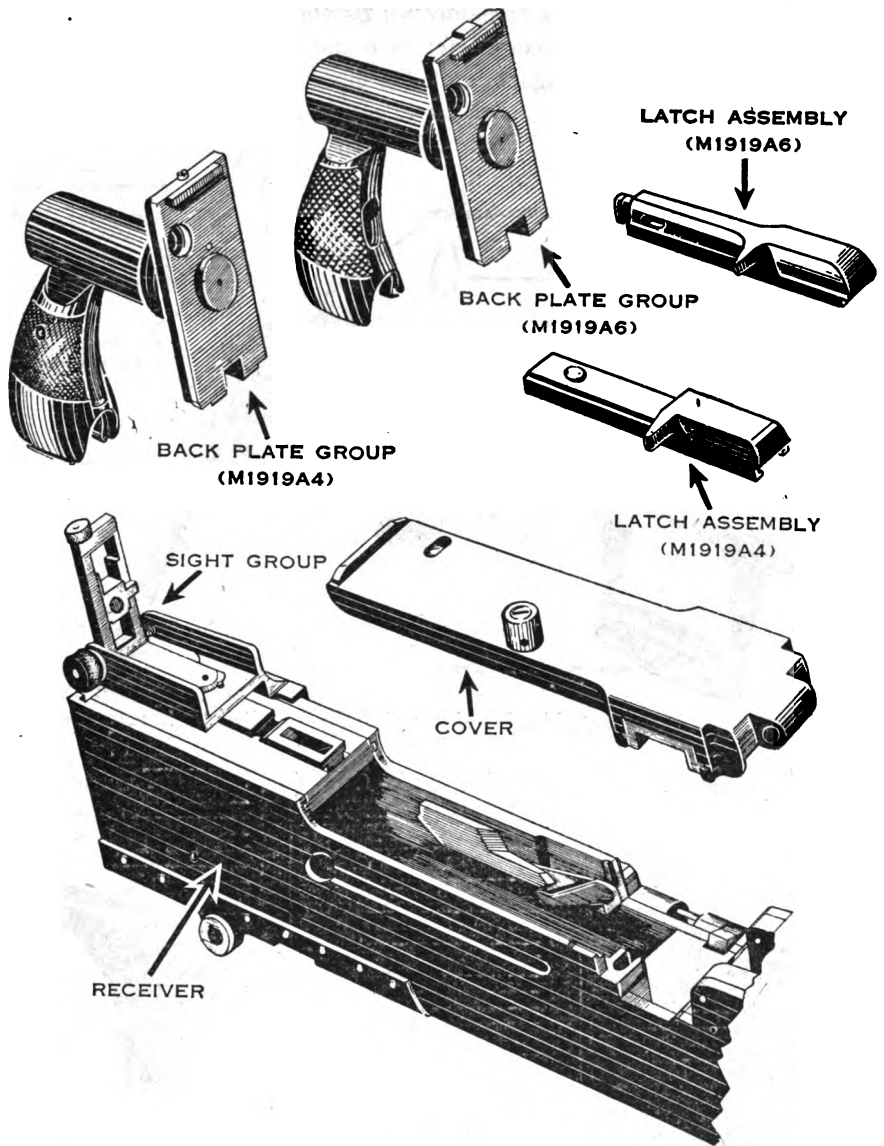


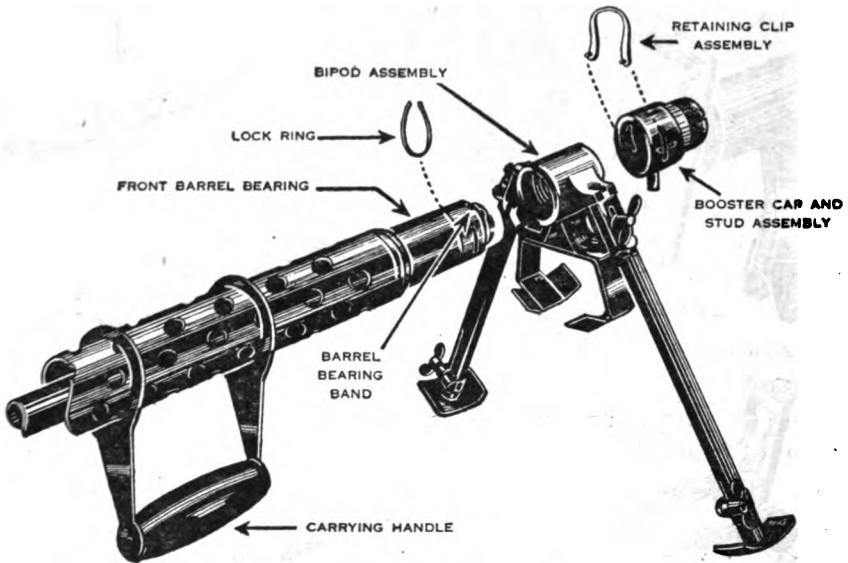
Figure 6(2). Groups of the M1919A4 and M1919A6 machine guns. (For the lock frame, bolt, and barrel extension groups see fig. 6(1).)

(2) Remove the cover bolt, cover catch spring, the fixed and movable plates, and the cover.

(3) Lower the rear sight leaf of the M1917A1 gun.

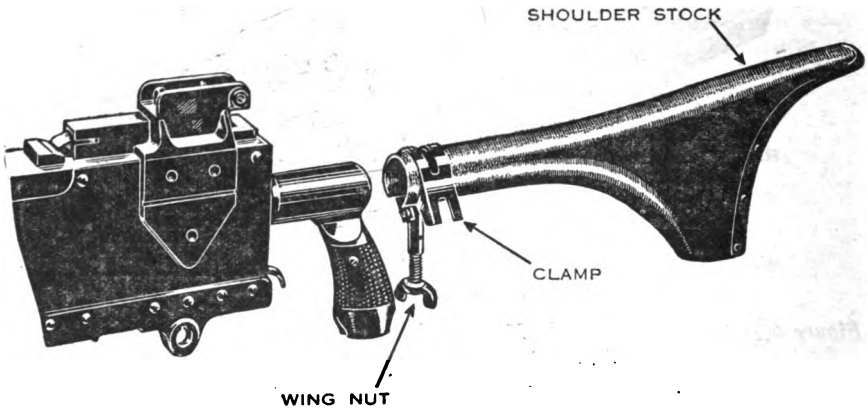
*Note.* To prevent undue wear, the cover and latch should not be removed except when necessary for cleaning or replacement of parts.

*g.* BOOSTER CAP, BIPOD, AND CARRYING HANDLE OF M1919A6 GUN (fig. 7). Turn the booster cap one-quarter turn and remove it from the barrel jacket. Pry off the lock ring, slide off the bipod leg assembly, and remove the carrying handle.



*Figure 7. Booster cap, bipod, and carrying handle of the M1919A6 gun.*

*h.* SHOULDER STOCK OF THE M1919A6 GUN (fig. 8). Loosen the wing nut on the clamp assembly and slide the stock assembly off the buffer tube.



*Figure 8. Shoulder stock of the M1919A6 gun.*

## 8. Replacing Groups in Guns

*a.* SHOULDER STOCK OF M1919A6 GUN. Slide the shoulder stock assembly onto the buffer tube and tighten the wing nut.

b. **CARRYING HANDLE, BIPOD, AND BOOSTER CAP OF M1919A6 GUN.** Slide the carrying handle onto the barrel jacket. Assemble bipod assembly to the front barrel bearing, and replace the lock ring. Place the booster cap on the front barrel bearing so that the retaining clip is up, making sure that the slots in the booster cap mate with slots in the front barrel bearing. Push the retaining clip assembly until it snaps into engagement with the slots in the front barrel bearing.

c. **COVER.** Place cover catch spring on cover bolt and position the fixed and movable plates. Insert the cover bolt in the cover hole. Place the screw driver end of the combination tool in the slit in cover bolt to prevent it from turning, and screw the nut on cover bolt until the desired tension is obtained. Replace the cotter pin. On the M1917A1 gun, raise the sight leaf before the cover is raised.

d. **LATCH.** Push the latch onto the top plate from the rear, keeping spring up so that it does not catch on rear of the top plate.

e. **BARREL EXTENSION AND BARREL.** (1) Screw the barrel and barrel extension together until the rear end of the barrel is flush with the inside of the barrel extension.

(2) Insert the barrel and barrel extension into the receiver until the lower rear lugs of the barrel extension are against the bottom plate (M1917A1 gun), or until the forward end of the barrel extension is opposite the rear end of the receiver (M1919A4 and M1919A6 guns).

f. **LOCK FRAME (fig. 9).** (1) Take the lock frame in both hands with

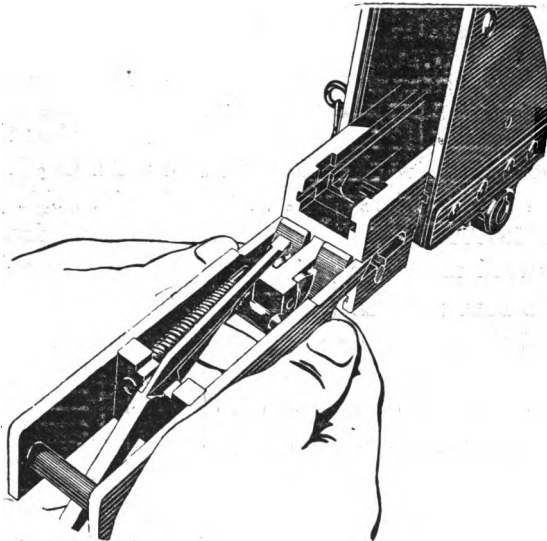


Figure 9. Assembling the lock frame of the M1917A1 gun to the barrel extension.

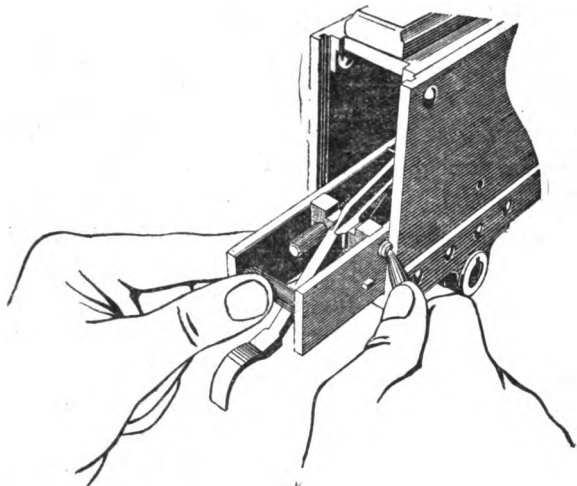
the index fingers beneath and supporting the accelerator (M1917A1 gun) or hold the barrel extension with one hand, and grip the lock frame in the other hand so that the index finger is beneath and supporting the accelerator (M1919A4 and M1919A6 guns).

(2) Place the claws of the accelerator in front of and against the T-lug.

(3) Insert the front projections of the lock frame in the slots of the barrel extension and push forward until the accelerator turns backward, locking the lock frame to the barrel extension.

(4) Push down the tips of the accelerator to insure positive locking.

(5) Force the trigger pin inward to clear it from the right side plate, and push the parts into the gun. (See fig. 10.)



*Figure 10. Replacing the lock frame, barrel extension, and barrel.*

(6) Continue pushing forward until a click is heard as the trigger pin springs out and into its seat in the right side plate. Check to make sure the trigger pin head appears in its seat in the right side plate. (If the barrel of the M1919A4 or M1919A6 gun is hung on the front barrel bearing, reach forward under the jacket and align the barrel.)

*g. BOLT AND BOLT HANDLE* (fig. 11). Push the cocking lever forward and insert the bolt, pushing down on the rear end of the trigger to prevent the front of the bolt from tripping the accelerator. Insert the bolt handle through the large opening at the rear of the slot and push it forward about 1 inch, being sure that the collar on the handle is inside of the right side plate.

*h. BACKPLATE.* Push forward on the latch and replace the backplate. Hold the bolt handle fully back with the left hand, place the rim of a cartridge, or the screw driver end of the combination tool, in the slit in the

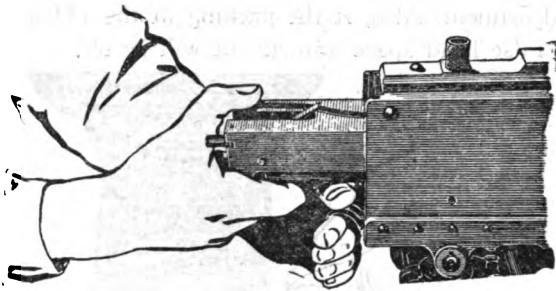


Figure 11. Replacing the bolt.

end of the driving spring rod, and turn the rod one-quarter turn counterclockwise until the slit is horizontal. This releases the driving spring. Allow the bolt to go forward.

*i. HEAD SPACE ADJUSTMENT.* (1) *Importance.* The head space of a military weapon, with the cartridge fully seated in the chamber, is the distance between the base of the cartridge and the face of the bolt. In Browning machine guns head space is adjusted by obtaining the proper distance between the forward part of the bolt and the rear end of the barrel. Proper adjustment is necessary in order to insure continued operation, to obtain the best uniformity of shot patterns, and to prevent damage to the gun.

(2) *Adjustment.* The head space adjustment is correct when the breech lock rides smoothly up the breech lock cam into its fully locked position and is in positive contact with the forward wall of the breech lock recess, and the forward end of the bolt is positioned against the rear end of the barrel. The adjustment is made as follows:

(a) Pull the bolt to the rear about  $\frac{3}{4}$  inch.

(b) Screw the barrel into the barrel extension, using the nose of a cartridge or the combination tool in the barrel notches, until the recoiling parts will not go into battery under pressure of the driving spring when the bolt handle is released. Then unscrew the barrel from the barrel extension one notch at a time (checking after each notch) until the barrel and barrel extension will just go fully forward into battery without being forced. (See fig. 12.) Then unscrew the barrel one additional notch. If correctly adjusted the recoiling parts will go into battery without the least bind, and with a solid metallic sound when eased forward from approximately 1 inch out of battery position. It is important to obtain this adjustment before backing off the barrel the additional notch.

*Note.* There are no head space or timing gauges issued for caliber .30 ground machine guns.

**Caution:** Care must be exercised to avoid roughening the barrel surface



during the adjustment. Also, if the packing of the M1917A1 gun binds the barrel, a false head space adjustment will result.

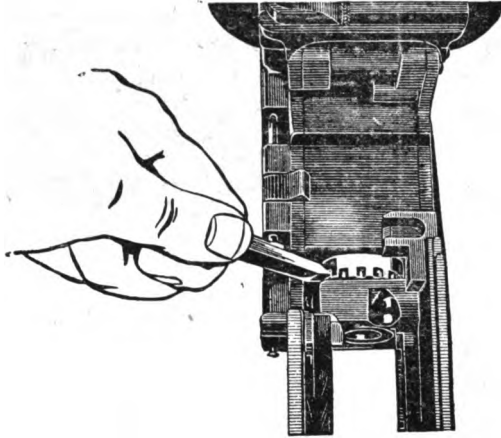


Figure 12. Making head space adjustment.

(3) *Alternate method of making head space adjustment.* Head space adjustment can be made before the moving parts are assembled in the receiver, as follows: Screw the barrel and barrel extension together until the rear of the barrel is flush with the inside of the barrel extension. Remove the extractor from the bolt. Place the bolt in the bolt guides in the barrel extension. Push the bolt fully forward. Turn the assembly so that the bolt is down. Lock the bolt to the barrel extension by pushing the breech lock fully into its recess in the bolt. Hold it firmly in that position with the thumb. Screw the barrel and barrel extension together until the barrel is stopped by contact with the bolt. Be certain that the barrel does not force the breech lock from its fully locked position. Turn the assembly so that the bolt is up. Unscrew the barrel and barrel extension just enough to cause the breech lock to fall from its recess. Remove the bolt. Screw the barrel and barrel extension together one notch, or if the nose of the barrel locking spring is between two notches, one and the fraction notches. Assemble the gun.

(4) *Making quick head space adjustment.* After the correct head space has been determined by either of the above methods, the notch in which the barrel locking spring is engaged may be marked with a center punch. Thereafter, screw or unscrew the barrel and barrel extension until the barrel locking spring is in the marked notch.

(5) *Improper head space adjustment.* (a) *Insufficient or tight head space.* When the head space adjustment is insufficient (tight), poor functioning will result, as the breech lock will not fully enter its recess in the bolt. This condition may damage the barrel extension, bolt, or breech lock.

Extraction trouble may also occur because of improper timing of locking and unlocking. Furthermore, with a tight head space adjustment, the gun operates sluggishly because of the binding of the moving parts. If the head space adjustment is very tight, the notches on the rear end of the barrel can be seen protruding from beneath the feedway, the bolt handle will not be fully forward, and the firing pin cannot be released by pressing the trigger.

(b) *Excessive or loose head space.* When the head space adjustment is excessive (loose), there will be play between the bolt and the barrel. This may cause a rupture of the cartridge case when the bolt is violently started to the rear independently of the barrel and barrel extension. If there is a weakness in the cartridge case itself, such as a split case, the possibility of a ruptured cartridge is increased.

j. **COVER.** With the bolt fully forward, position the stud of the belt feed lever to the left (fig. 13) and close the cover, being sure that the latch engages. Pull the trigger.

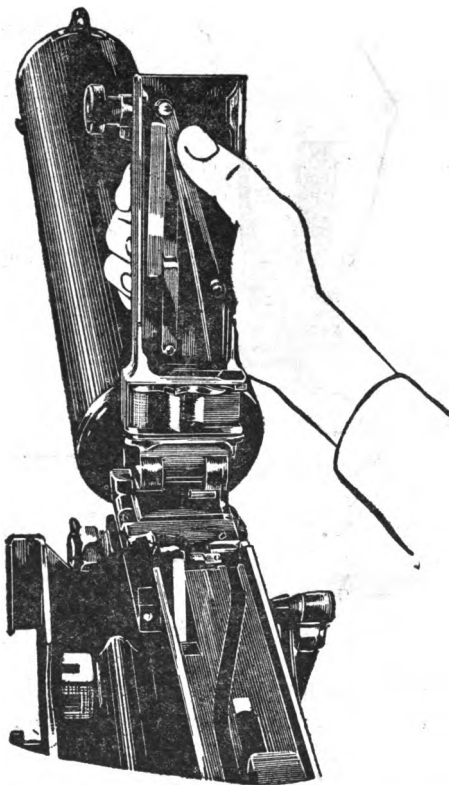


Figure 13. Positioning the belt feed lever stud.

## 9. Detailed Disassembly of Bolt

a. **EXTRACTOR.** Raise the extractor and remove it.

b. **DRIVING SPRING ROD (fig. 14).** *Great care should be exercised in removing the driving spring rod from the bolt as the force of the driving spring when released can easily cause the rod to jump from the hand and possibly result in injury to personnel.* To remove the driving spring rod, place the protruding end of the rod on a table or a block of wood. Grasp the bolt firmly in the right hand (palm of the hand over the face of the bolt), press down and at the same time turn the bolt one-fourth turn to the left, releasing the driving spring rod pin from its recess in the bolt. Slowly release pressure on the bolt allowing it to rise under the action of the driving spring until about 3 inches of the rod protrudes. Grasp the protruding portion of the rod and spring and lift the bolt from the table, holding the rod and spring in their same position relative to the bolt. Separate the rod and spring from the bolt with a quick jerk. The quick, separating jerk will prevent the spring from kinking. Remove the driving spring rod from the driving spring.

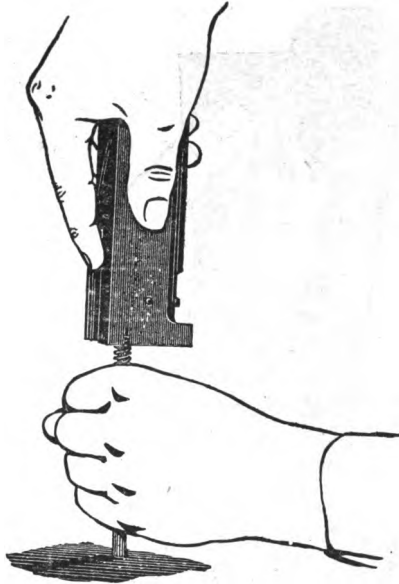
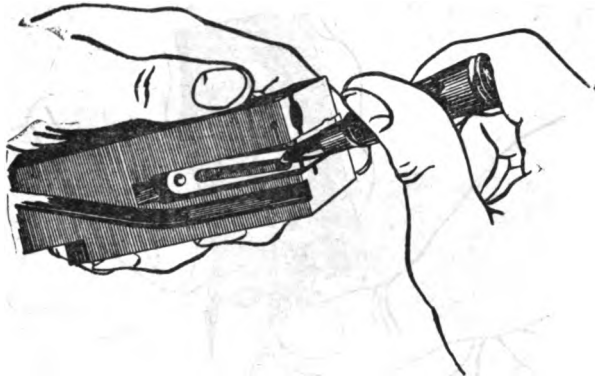


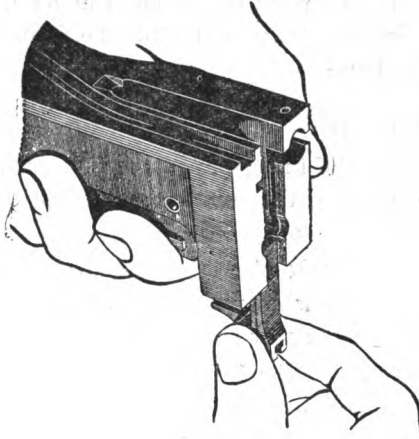
Figure 14. Removing the driving spring and rod.

c. **COCKING LEVER.** Rotate the top of the cocking lever to the rear of the bolt and withdraw the cocking lever pin from the bolt. Lift out the cocking lever.

d. **SEAR (figs. 15 and 16).** Hold the bolt with the front end toward the body and release the firing pin by pushing down on the sear. Place the



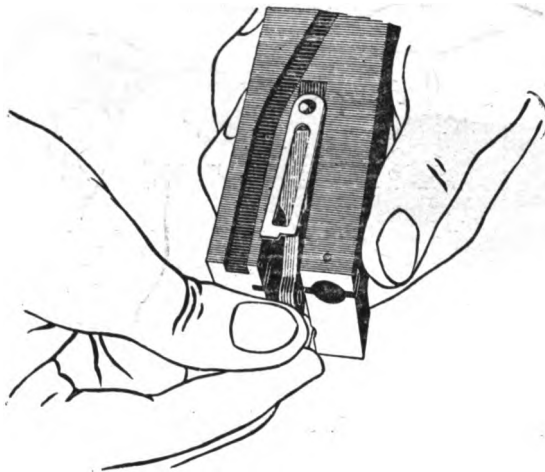
*Figure 15. Seating the sear spring in the cut in the bolt.*



*Figure 16. Removing the sear.*

nose of a cartridge near the end of the sear spring, away from the sear spring pin, and push downward and to the right on the spring to seat it in the cut in the bolt. This releases the sear, which is removed at the bottom of the bolt.

*e. SEAR SPRING AND PIN* (fig. 17). Turn the sear spring back to its normal position to clear the cut. Push the nose of a cartridge into the hole in the bottom of the bolt to start the sear spring pin moving outward. Place the top end of the cocking lever well under the sear spring and pry the pin out of the bolt.



*Figure 17. Removing the sear spring and pin.*

*f. FIRING PIN.* Place the palm of the hand under the rear of the bolt, tilt the rear end of the bolt down, and allow the firing pin to fall out and into the palm of the hand.

#### **10. Assembling Bolt (fig. 18)**

*a. FIRING PIN.* Place the firing pin in the bolt, striker downward and to the front; tilt the front of the bolt downward until the striker projects through the small hole in front of the bolt.

*b. SEAR SPRING AND PIN.* Replace the sear spring and pin by inserting the pin in its recess and pushing with a cartridge on its top, avoiding pressure on the leaves of the sear spring itself.

*c. SEAR.* Hold the bolt in the left hand, front end toward the body, top up. With the point of a cartridge placed near the end of the sear spring, away from the pin, push downward and to the right to seat its edge in the cut in the bolt. With the notched projection of the sear to the front, push the sear upward from the bottom, holding it with the first finger of the left hand. Press downward and to the left on the sear spring with a cartridge to engage the end of the spring in the sear.

*d. COCKING LEVER.* Replace the cocking lever, making certain that the rounded nose on the lower end is to the rear and in its recess in the firing pin. Insert the cocking lever pin from the left side of the bolt. The upper end of the cocking lever should be to the rear of the bolt and the hole in the cocking lever aligned with the hole in the bolt before inserting the pin. To test the correctness of the assembly, cock by pressing forward on the upper end of the cocking lever, then rotate it to the rear and press down on the sear with a cartridge. This should release the firing pin.

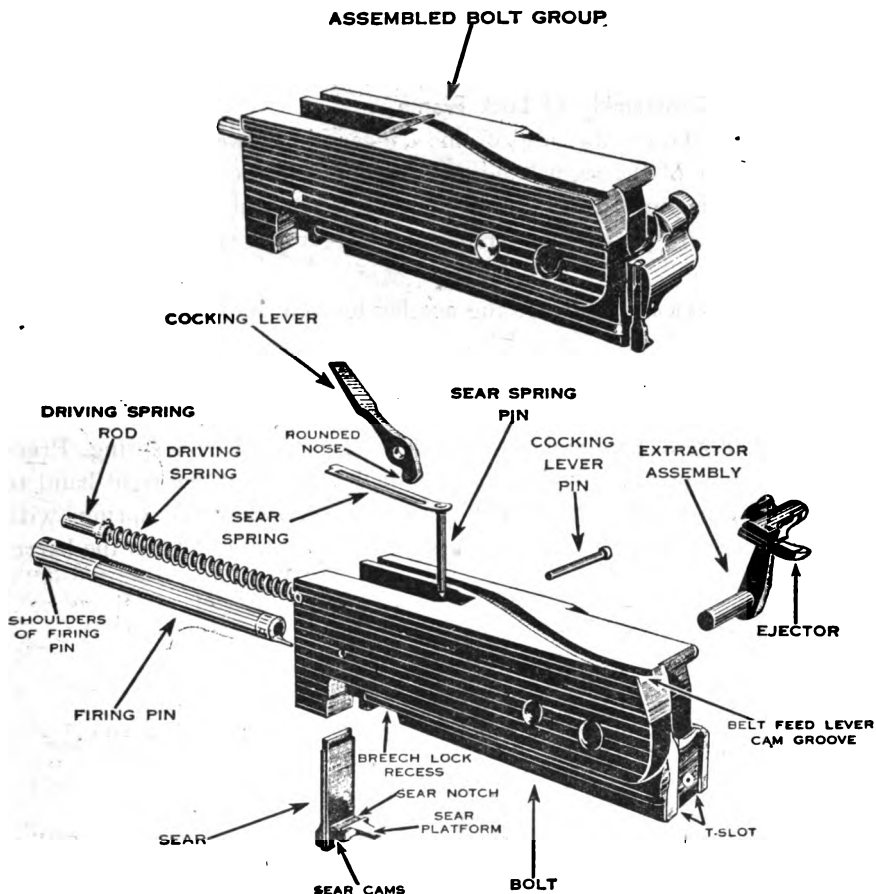


Figure 18. Bolt group.

e. **DRIVING SPRING ROD.** *The same degree of care should be exercised in assembling the driving spring rod to the bolt as in removing it.* Place the driving spring on the driving spring rod. With the back end of the rod resting on a table or a block of wood, gather as much of the spring on the rod as can be held compressed by the thumb and fingers of the left hand. With the bolt securely held in the right hand, front end of the bolt in the palm of the hand, slip the bolt over the end of the spring. Push downward to compress the spring and allow the driving spring rod pin to enter the slot in the side of the bolt. Turn the bolt slowly 90° clockwise until the slit in the rod is crosswise (vertical) to the slot in the side of the bolt, with the pin firmly engaged.

f. **EXTRACTOR.** Insert the extractor stud in the rear hole of the two large holes in the left side of the bolt, the extractor pointing up. Turn the

extractor downward toward the front to engage the collar on the extractor under the collar cut in the bolt.

### 11. Detailed Disassembly of Lock Frame

a. **TRIGGER.** Grasp the head of the trigger pin between the thumb and the first finger of the right hand and remove it to the right. Lift out the trigger. If the pin is too tight to permit its removal in this manner, it must be drifted out. Do not remove the trigger pin spring except when necessary.

b. **ACCELERATOR.** Push out the accelerator pin and remove the accelerator.

c. **BARREL PLUNGER (fig. 19).** Hold the lock frame with the left hand, projections pointing upward, slot to the left, separator between the second and third fingers, first and second fingers gripping barrel spring. Press down and out on the barrel plunger with the thumb of the right hand to disengage the plunger guide pin from its slot. Allow the spring, with plunger, to rise slowly. Lift out the spring and remove it from the barrel plunger.

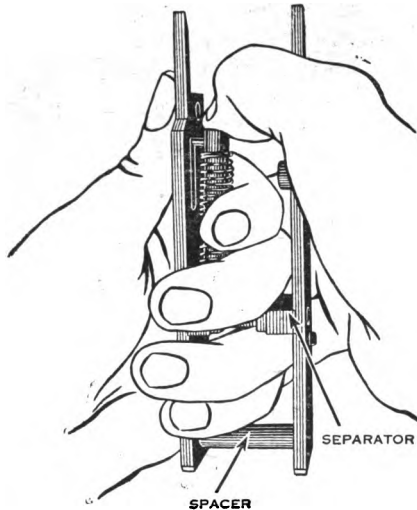


Figure 19. Removing the barrel plunger and spring.

### 12. Assembling Lock Frame (fig. 20)

a. **BARREL PLUNGER.** Assemble the barrel plunger spring to the barrel plunger. Holding the lock frame as shown in figure 19, seat the end of the barrel plunger spring in the recess in the lock frame separator, barrel plunger guide pin facing the slot in the lock frame. Using the first and second fingers of the left hand to prevent the spring from buckling, press down with the thumb of the right hand on the end of the barrel plunger

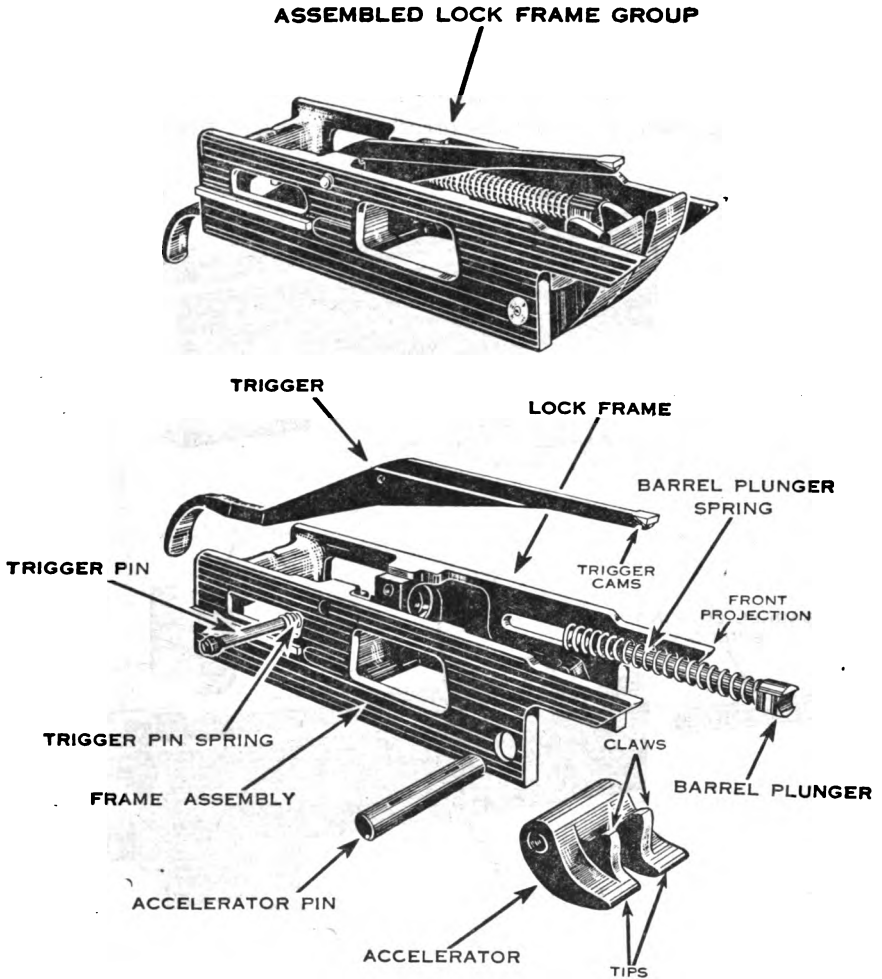


Figure 20. Lock frame group.

until the barrel plunger guide pin can be seated in the slot. Care should be taken that the action of the spring does not cause the plunger to slip out of the hand.

*b. ACCELERATOR.* Replace the accelerator with the tips up and the rounded surface to the front. Insert the accelerator pin, taking care that both ends of the pin are flush with the sides of the lock frame.

*c. TRIGGER.* Push the front end of the trigger up under the spacer and over the separator, placing the center in its square seating. If the trigger pin spring has been removed, seat the spring on the trigger pin, placing the small end of the spring toward the head of the pin. Replace the pin from the right.



### 13. Detailed Disassembly of Barrel Extension (fig. 21)

a. **BARREL LOCKING SPRING.** Insert the rim of a cartridge under the hook of the barrel locking spring and pull it out.

b. **BREECH LOCK.** Push out the breech lock pin and remove the breech lock.

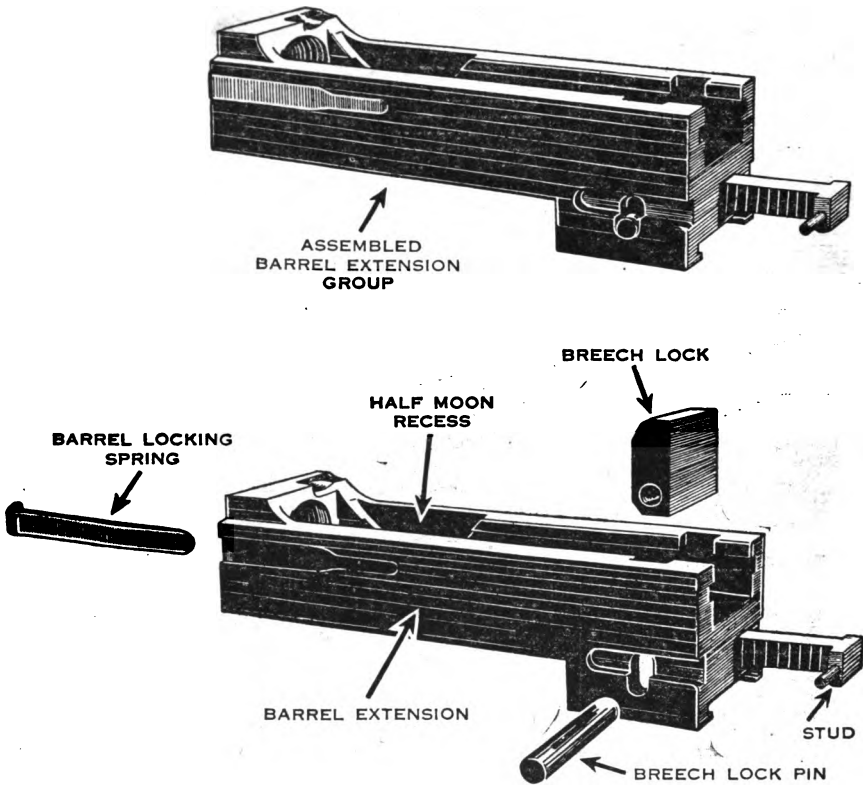


Figure 21. Barrel extension group.

### 14. Assembling Barrel Extension

a. **BREECH LOCK.** Place the breech lock in its slot, *taking care that the double beveled edge is up and to the front*. Insert the breech lock pin and insure that both ends of the pin are flush with the sides of the barrel extension.

b. **BARREL LOCKING SPRING.** Insert the barrel locking spring in the seating in the left side of the barrel extension, hook inward, and force home as far as it will go.

### 15. Detailed Disassembly of Cover (fig. 22)

a. **BELT FEED LEVER PIVOT.** Take out the cap, plug, or screw from the

belt feed pivot bushing nut and remove the belt feed lever pivot and washer.

b. **BELT FEED LEVER.** Withdraw the belt feed lever from its recess in the belt feed slide and remove lever.

c. **SLIDE AND PAWL.** Remove belt feed slide by sliding it from the cover. Push out the belt feed pawl pin from the slide and remove the pawl and spring.

d. **COVER EXTRACTOR SPRING.** With the thumb, press down on the locking end of the cover extractor spring and guide it from its recess under the cover extractor cam. *This spring must be held down with the thumb while being guided from its recess, as it is under strong tension.*

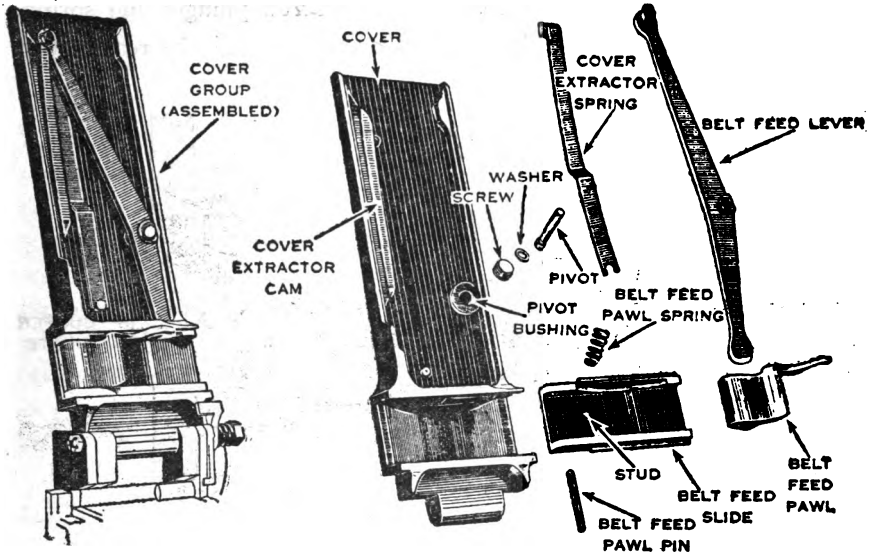


Figure 22. Cover group.

## 16. Assembling Cover.

a. **COVER EXTRACTOR SPRING.** Place the forked end of the cover extractor spring in its recess in the stud. Press down on the locking end of the spring and when it is fully depressed push the projection of the spring into the notch of the cover extractor cam.

b. **SLIDE AND PAWL.** Place the small end of the belt feed pawl spring over its stud in the slide. Place the belt feed pawl over the slide so that the large end of the belt feed pawl spring fits into its recess in the pawl. Push down on the pawl and align the holes of the pawl and slide. Insert the belt feed pawl pin so that its ends are flush with the sides of the slide. Replace the belt feed slide in its grooves in the cover, taking care that the

pawl is pointing to the right when the cover is assembled to the gun.

c. **BELT FEED LEVER.** Insert the rounded end of the belt feed lever through the slot in the cover and in its recess in the belt feed slide. Be sure the lever stud is away from the cover and to the rear. Position the pivot hole in the lever over the pivot hole in the bushing nut.

d. **BELT FEED LEVER PIVOT.** Insert the belt feed lever pivot in the top of the belt feed lever pivot bushing nut so that the pivot extends through the hole in the belt feed lever below. Drop in the shakeproof lock washer and screw in the belt feed lever pivot screw until tight.

## 17. Disassembly and Assembly of Parts Dismounted for Repair Only

a. **SHOCK-ABSORBING GROUP** (fig. 23). (1) *Disassembly.* (a) Unscrew the adjusting screw and remove the adjusting screw plunger and spring.

(b) Remove the buffer disks and buffer plate through the rear end of the grip.

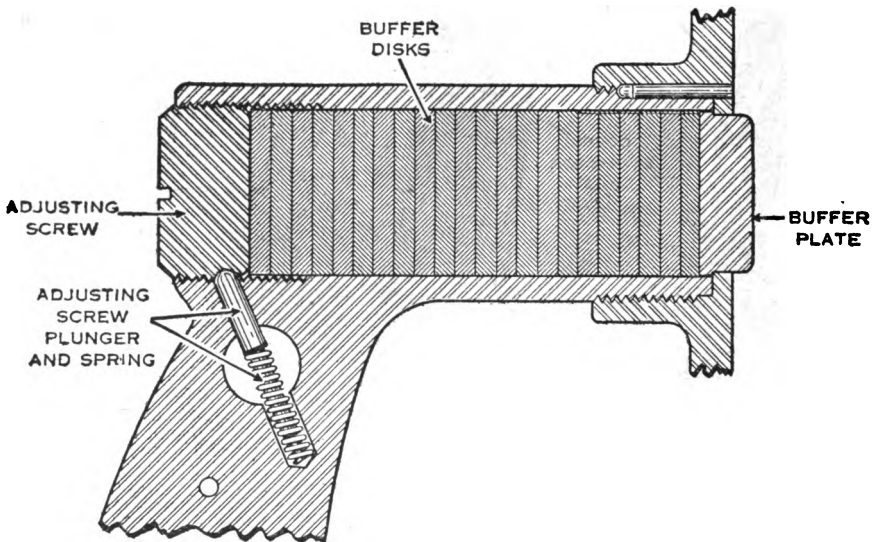


Figure 23. Shock-absorbing group.

(2) *Assembly.* Replace the parts in reverse order. In assembling the shock-absorbing group, it must be kept in mind that part of the recoil energy of the bolt is transmitted to the buffer pile (the assembled buffer disks) in the form of metal-to-metal impact with great force. In order that the buffer pile may absorb this force, the following precautions must be observed:

(a) The buffer disk pile must always form a compact column compressed between the buffer plate and the adjusting screw.

(b) The disks should be clean and free from rough edges and surfaces. Use sufficient disks so that when the adjusting screw is inserted and tightened, its rear face will be flush with or protrude slightly from the rear face of the grip. If the adjusting screw becomes below flush with the rear face of the grip, remove the screw and add one or more disks. Firing the gun with the adjusting screw below flush is prohibited.

(c) After assembly, adjust the buffer by tightening the adjusting screw, making sure that the adjusting screw does not protrude more than one thread.

(d) Substitution of other material for these disks is prohibited.

b. BELT-HOLDING PAWL. (1) Hold down the belt-holding pawl and withdraw the belt-holding pawl split pin to the rear.

(2) Lift off the belt-holding pawl.

(3) Lift the belt-holding pawl spring from its seating.

(4) Assemble in reverse order.

c. STEAM TUBE FOR M1917A1 GUN (fig. 24). (1) The steam tube should never be removed unless it becomes so clogged that steam will not pass off, or the outer tube becomes stuck so it will not slide back and forth on the inner tube when the gun is held in the hands and tipped forward and backward. *Great care must be used to prevent damage to the threads of the steam tube front plug.* It should never be removed except under the supervision of an officer, or by an experienced armorer or ordnance personnel.

(2) Drain the water jacket. Stand the gun with the muzzle up and

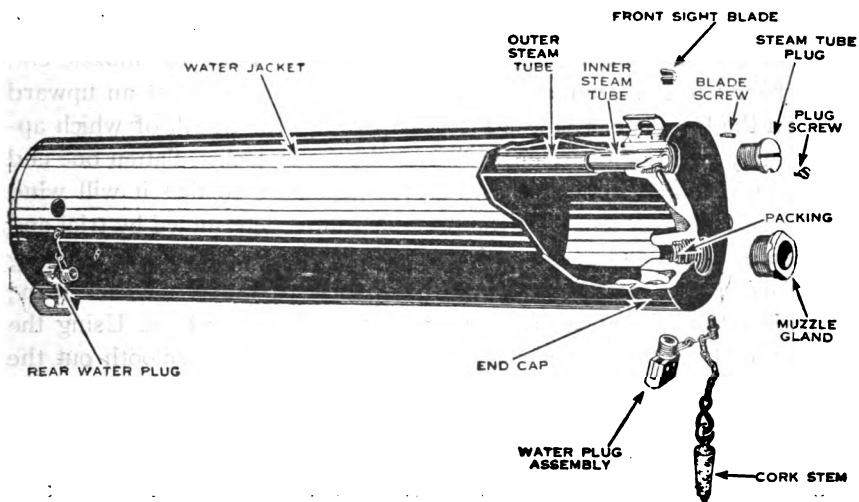


Figure 24. Steam tube assembly and water jacket of the M1917A1 gun.

the water jacket vertical. Remove the steam tube front plug screw. Unscrew the steam tube front plug until the threads are disengaged and the tube can be lifted out.

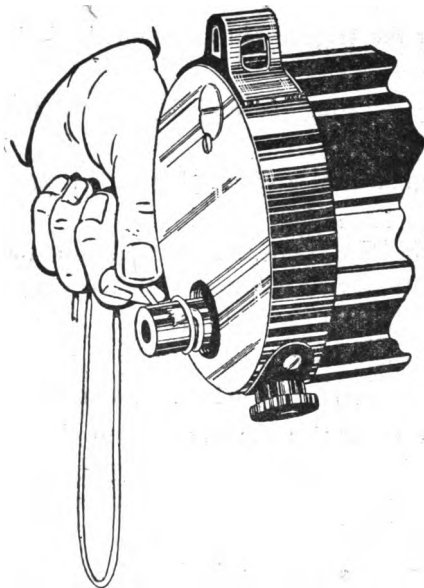
(3) To assemble, stand the gun as prescribed in (2) above, and insert the steam tube. Gently screw in the threads, stopping at once if there is any undue resistance. The gun and tube must be exactly vertical to insure that the conical end of the tube enters its seating in the trunnion block. By removing the rear water plug on the jacket, and directing a flashlight or sunlight inside the jacket, it can be determined when the conical end of the tube is aligned with its seating in the trunnion block. Forcing the screw against resistance will damage the threads. If it does not screw in easily, unscrew it a short distance, be sure the water jacket is vertical, and try again until the threads screw in smoothly. Screw in tight without excessive force, and then position the notch in the rim of the plug exactly on the round countersunk recess for the front plug screw, unscrewing part of a turn if necessary. Replace the screw and screw it firmly into its countersunk seating. If the notch in the rim is not engaged by the screw head, the steam tube will not be aligned to permit the escape of steam through the end cap and the steam generated in firing will cause the water jacket to burst.

#### **18. Packing Barrel of M1917A1 Gun**

Asbestos packing is applied at the muzzle and breech ends of the barrel to prevent leakage from the water jacket. The amount of packing must not be excessive, since the friction caused thereby will interfere with the action of the mechanism. The packing should be well saturated with oil before being applied.

a. **PACKING BREECH END.** Disassemble the gun. Place the muzzle end of the barrel in the trunnion block so that the barrel rests at an upward angle on the top plate. Using a piece of packing, the length of which approximately equals the circumference of the water jacket, flatten one end of the packing and place that end in the cannellure so that it will wind clockwise. The *exact* length of the packing will be determined by trial and experience. Wind the packing clockwise over the flattened end, binding it in place. Press the packing toward the forward wall after each turn; on the last turn, force the free end under the previous turn. Using the flat side of the screw driver end of the combination tool, smooth out the packing. Lift the barrel from its position on the receiver, reverse the direction of the barrel, insert its breech end in the hole in the trunnion block, and push it forward gently. Twist the barrel clockwise until the packing is worked down to fit the hole. Then reassemble the gun and make head space adjustment.

b. **PACKING MUZZLE END** (fig. 25). To pack the muzzle end, one man takes his position at the front end of the gun and removes the muzzle gland. Taking a piece of packing about twice the circumference of the water jacket in length, he flattens out one end of the packing and places that end as close as possible to the end cap. (If the packing is thick, it may be necessary to remove one strand.) He then winds one turn of packing clockwise over the flattened end, binding it in place, and slips the muzzle gland over the muzzle, forcing the first coil of packing back into its seat under the end cap. He continues to wind the packing, similarly forcing each turn back into its seating by means of the muzzle gland. The muzzle gland is then screwed into the end cap by the man who unscrewed it and the packing is worked down at the same time by another man pulling the bolt to the rear several times. If there is too much friction, remove one or two turns of packing. With the muzzle gland screwed in securely, there should be about three muzzle gland threads exposed on a newly packed barrel.



*Figure 25. Packing the muzzle end of the M1917A1 gun.*

## 19. Methods of Changing Parts

a. **GENERAL.** If the time element is important, a broken minor part should be replaced by substituting the complete spare group which contains it. Thus, a broken firing pin would be remedied by changing bolts. Damaged parts should be replaced as soon as opportunity permits and a

new replacement group assembled. Headspace adjustment should be checked if a group has been changed.

**b. SPARE PARTS.** Some of the spare parts for caliber .30 machine guns, M1917A1, M1919A4, and M1919A6 are interchangeable. They should be checked in pertinent Standard Nomenclature Lists A-5 and A-6. Since a small percentage of parts may vary slightly from standard dimensions, they should be tested in the gun in which they are to be used as soon as received. Any spare parts which do not fit properly should be replaced.

**c. CHANGING PARTS OF M1917A1 GUN.** When changing parts of the M1917A1 gun requiring the removal of the barrel, it is often necessary to save the water in the water jacket. This depends entirely upon prevailing conditions; in battle, water may not be obtained readily, and time also may be of the utmost importance. If it is necessary to save the water in the water jacket when changing parts which require the removal of the barrel, one of the following methods should be employed:

(1) *First method.* (a) Remove the bolt.

(b) Push in on the trigger pin and pull the lock frame to the rear from  $\frac{1}{4}$  to  $\frac{1}{2}$  inch.

(c) Remove the elevating pin and depress the muzzle by raising the rear end of the gun.

(d) Hold a plug, such as a steam plug cork wrapped in clean patches, at the muzzle.

(e) Withdraw the lock frame, barrel extension, and barrel to the rear. As the barrel is withdrawn, follow it with the plug or steam plug cork and insert it in the hole in the end cap.

(f) Replace the necessary part.

(g) Place a plug or twisted patch in the muzzle of the barrel.

(h) Replace the groups in the gun. When the muzzle of the barrel passes through the hole in the end cap, the plug or steam plug cork will be forced out. *After removing the plug or twisted patch from the muzzle, run a patch through the barrel.*

(i) In removing and replacing the barrel, care must be exercised not to disarrange the packing. Frequently, in assembling, the barrel pushes the front packing out of its seat in the end cap.

(j) Adjust the head space.

(2) *Second method.* Drain the water from the water jacket into the water chest. This method requires more time than the method described above, as the water jacket has to be refilled after the new barrel is seated.

**d. QUICK METHOD OF CHANGING BARREL ON M1919A6 GUN.** (1) Re-

move the booster cap, unscrew the barrel (using the M6 combination wrench), and slide it out of the barrel jacket. Use asbestos mittens if the barrel is hot.

(2) Slide a new barrel into the barrel jacket, screw the barrel into the barrel extension, and replace the booster cap. Adjust head space. (See par. 8i2(b).)

### Section III. CARE AND CLEANING

#### 20. Importance

The care and cleaning of the machine guns, mounts, and accessories are the duty of the gun crew or other personnel using the gun. Experience has shown that more machine guns have become unserviceable through improper care and cleaning than from extensive use.

#### 21. Lubricants, Cleaning Materials, and Rust Preventives

The use of unauthorized cleaning materials, such as abrasives, is forbidden. The only materials authorized and issued for use in the care and cleaning of machine guns, mounts, and accessories, are—

*a.* RIFLE BORE CLEANER. This cleaner is issued for cleaning the bore of the machine gun after firing, and will provide temporary protection against rust. If cleaner freezes, thaw out and shake well.

*b.* SODA ASH. Soda ash is used to clean the bore of the barrel when rifle bore cleaner is not available. To use, dissolve 1½ tablespoons of soda ash in 1 pint of water (warm water if available).

*c.* SOAP. A solution of soap and water should be used to clean the bore if rifle bore cleaner or soda ash is not available. To use, dissolve ¼ pound of soap chips in 1 gallon of water (hot water if available).

*d.* LIGHT PRESERVATIVE LUBRICATING OIL (PL). This oil is used for the lubrication of all moving parts, and for preservation of metal surfaces of machine guns in actual service at temperature in excess of 0° F., except in areas of extreme moisture or high humidity.

*e.* MEDIUM PRESERVATIVE LUBRICATING OIL (PM). This oil provides short-term protection against rust, and should be used on guns exposed to salt water atmosphere and spray, high humidity, and extreme moisture. It should be used for oiling parts of weapons prior to landing operations.

*f.* SPECIAL PRESERVATIVE LUBRICATING OIL (PS). This oil will be used for oiling weapons at all temperatures. It provides the desired protection against corrosion under all atmospheric conditions except those specifically mentioned in *e* above. It replaces light preservative lubricating oil when stocks of the latter are exhausted.



*g.* **LIGHT RUST-PREVENTIVE COMPOUND.** This compound is used to protect metal parts for long storage periods and for preparing weapons for shipment.

*h.* **DRY-CLEANING SOLVENT.** Dry-cleaning solvent is a noncorrosive, petroleum solvent used to remove grease, oil, or rust-preventive compound. *It is highly inflammable; therefore, smoking and open fires must be prohibited in the vicinity of its use.*

*Note.* See TM 9-850 for detailed description of the above materials.

## **22. Care and Cleaning When Guns Have Not Been Fired**

*a.* **GENERAL.** Care and cleaning, during intervals between firing, are necessary to insure the proper condition of machine guns. Each gun must be completely disassembled in order to inspect, clean, and lubricate it properly. Machine guns in the hands of troops should be inspected daily.

*b.* **BORE AND CHAMBER.** (1) To clean the bore and chamber, attach a cloth patch to the cleaning rod and insert the patch in the bore *at the breech end*. Move it forward and backward several times and replace with a new patch. Make sure that the patch goes all the way through the bore before the direction is reversed.

(2) Repeat until a patch comes out clean.

(3) After thorough cleaning, saturate a patch with light preservative lubricating oil and run it through the chamber and bore. When no firing is being done, the bore and chamber should be cleaned and reoiled at 5-day intervals. This interval should be reduced under extreme atmospheric conditions when it is evident that more frequent application is required.

(4) When issue patches are not available, patches should be cut approximately  $2\frac{1}{2}$  inches square to permit their passage through the bore without bending the cleaning rod.

*Note.* *Never leave a patch or other obstacle in the chamber or bore of the gun.*

*c.* **RECEIVER.** (1) Disassemble, clean, and oil all moving parts completely.

(2) Clean the screw heads and crevices with a small cleaning brush or small stick.

(3) To clean the metal surfaces, rub with a dry cloth to remove moisture and dirt. Then wipe with a cloth that has been dipped in special preservative lubricating oil and wrung out. This protective film must be maintained at all times. To maintain the protective film, perform this service daily.

(4) Clean the dirt from the outer surfaces of the machine gun with a slightly oiled cloth, wipe with a soft dry one, and then oil. To remove

gummy deposits resulting from congealed oil, use rifle bore cleaner or dry-cleaning solvent and wipe dry before reoiling.

*d.* ACCESSORIES. (1) Care and cleaning will not be confined to the gun alone, but will include the mount, spare parts, and all accessories.

(2) Belts and ammunition must be kept clean and dry.

(3) Gun covers are provided to prevent dirt from entering the gun.

### 23. Preparatory to Firing

*a.* PROCEDURE. Before firing, take steps to insure efficient functioning of the guns. (See par. 36*b.*)

*b.* SPARE PARTS CHEST. The contents of the spare parts chest permit immediate replacement of unserviceable parts. The chest should, therefore, be kept complete at all times with its contents clean, serviceable, and lightly oiled.

### 24. During Firing

*a.* Oil frequently but *sparingly* the cam groove, the cocking lever, and the M1917A1 muzzle gland packing.

*b.* Avoid pulling a partially empty belt through the feed opening, as lint and dirt will interfere with the functioning and the feed mechanism. The cover may be raised and the empty part of the belt lifted and placed in or removed from the feedway. The cover is then closed.

*c.* Observe the functioning of the gun to anticipate failures.

*d.* Examine for water leakage on the M1917A1 gun.

### 25. After Firing

*a.* GENERAL. Machine guns must be thoroughly cleaned immediately after firing. Since the bore sweats, and to insure complete removal of powder residue and primer fouling, the bore cleaning procedure should be repeated on 3 consecutive days thereafter, or until there is no further evidence of sweating.

*b.* CLEANING BARREL WITH RIFLE BORE CLEANER. (1) Saturate a clean patch with rifle bore cleaner and swab the bore. Repeat this operation two or three times, using clean saturated patches each time, and running them completely forward and backward through the bore.

(2) If, after cleaning on the third day after firing, the weapon is not likely to be fired within the next 24 hours, wipe dry and oil. Otherwise, do not wipe dry, but leave the bore wet with rifle bore cleaner.

*c.* CLEANING BARREL WITH SODA ASH OR SOAP SOLUTION. (1) Place barrel, muzzle down, in a vessel containing soda ash solution, soap solution, or water, and swab the bore for 1 minute.

(2) While bore is wet, run a brass or bronze brush forward and back through the barrel three or four times.

(3) Using the cleaning rod and patch, pump clean water through the bore.

(4) Dry and oil as in *b* above.

*d.* **CLEANING PARTS OTHER THAN BARREL.** (1) Thoroughly clean the cover, bolt, barrel extension, lock frame, and backplate, using a small stick covered with a flannel patch, if necessary. Remove dirt and oil from all recesses and springs.

(2) Wipe all parts with a cloth, wet with oil.

*e.* **EXTERIOR SURFACES.** (1) Wipe off the exterior of the gun with a dry cloth to remove moisture and dirt.

(2) Wipe all metal surfaces with a cloth, wet with oil.

*f.* **ACCESSORIES.** Clean the mount and oil unpainted surfaces with preservative lubricating oil. Oil spare parts and all accessories with preservative lubricating oil.

*g.* **MOUNT.** (1) Clean and lightly oil all threads, the traversing dial, and other moving parts.

(2) Clean and then remove all oil from the serrations of the M1917A1 tripod legs, otherwise dirt and sand may collect and interfere with positive locking of the legs.

(3) Remove, clean, and lightly oil the M1917A1 tripod cradle pintle.

(4) Clean and dry the traversing dial seat. Do not place oil in the seat, as this will cause dirt to collect and interfere with easy dial adjustment.

(5) The gun pintle bushing should be cleaned and lightly oiled.

*h.* **BOOSTER CAP AND FRONT BARREL BEARING, M1919A4 AND M1919A6 GUNS.** (1) Carbon is deposited in the booster cap and front barrel bearing, M1919A4 and M1919A6 guns, during firing. If this deposit is not removed periodically, it will eventually cause the barrel to bind.

(2) Unscrew the front plug with the combination tool and scrape out the carbon.

## **26. Preparation for Storage**

*a.* Medium preservative lubricating oil is most suitable for short-term storage (less than 30 days).

*b.* Before storing, machine guns, mounts, and accessories should be thoroughly cleaned and oiled. The bolts should be in the forward position with firing pins released. Wooden supports of the packing boxes must be painted with rust-preventive compound.

c. Under no circumstances will a gun be placed in storage while contained in a cloth or other cover, or with a plug or patch in the bore.

## 27. Cleaning Weapons Received from Storage

a. Use corrosion preventive solvent to dissolve and remove all traces of oil or rust-preventive compound.

b. Wipe thoroughly dry and follow the instructions in paragraph 22.

## 28. Care and Cleaning Under Unusual Conditions

a. CARE AND CLEANING IN COLD CLIMATES (FM 70-15). (1) It is necessary that the moving parts of the weapons be kept absolutely free from moisture. It has also been found that excess oil on the working parts will solidify and cause sluggish operation or complete failure.

(2) Before firing in temperatures below 0° F., completely disassemble and clean all parts of the gun thoroughly and oil by rubbing with a cloth which has been dipped in oil and wrung out.

(3) Drain the water from the jacket of the M1917A1 gun and add an antifreeze compound. (See par. 30.)

(4) Upon bringing the gun indoors, it should *first* be allowed to come to room temperature; then be disassembled, wiped completely dry of all moisture which may have condensed on the cold metal surfaces, and thoroughly oiled with lubricating oil.

(5) If possible, condensation should be avoided by providing a cold place in which to keep the gun when it is not in use. For example, a separate cold room or, when in the field, platforms with proper cover may be used.

(6) If the gun has been fired, the bore should be immediately swabbed out with an oily patch and, when the weapon reaches room temperature, thoroughly cleaned and oiled as described in paragraph 25.

b. CARE AND CLEANING IN TROPICAL CLIMATES (FM 72-20). In tropical climates where temperature and humidity are high, the weapon should be thoroughly inspected daily by dismounting and, if necessary, disassembling the groups to permit drying and oiling the parts. Care should be exercised to see that all unexposed parts, as well as all surfaces, are kept clean and oiled.

c. CARE AND CLEANING IN HOT, DRY CLIMATES. (1) In hot, dry climates where sand and dust are apt to get into the mechanism and bore, the weapons should be wiped clean at least once daily. Groups should be disassembled to facilitate thorough cleaning.

(2) When the weapon is used under sandy conditions, all lubricant should be wiped from exposed and noncritical operating surfaces. This

will prevent sand carried by the wind from sticking to the lubricant and forming an abrasive compound which will damage the mechanism.

(3) Immediately upon leaving sandy terrain, the weapon should be cleaned and lubricated with light preservative lubricating oil.

(4) Care must be taken in handling the gun,\* as perspiration from the hands contains acid which causes rusting. Wipe the gun frequently with a dry cloth.

(5) During sand or dust storms, the gun should be kept covered, if possible. Immediately after such storms, it should be cleaned.

## 29. Care During Gas Attack

a. GENERAL. (1) A complete suit of protective clothing and a service gas mask should be worn during decontaminating operations.

(2) It is important to prevent the chemicals used in a gas attack from getting in or on the gun and ammunition. When a gas attack is anticipated, cover the gun, ammunition, mount, spare parts, and accessories.

(3) If time permits, apply oil to the surfaces of all the parts of the weapon, mount, accessories, and spare parts.

(4) If the gun is not being used, oil it and then cover it with a canvas gun cover or place in a container so that it cannot come into contact with any contaminating chemicals.

(5) After the attack, clean the material with dry-cleaning solvent, if uncontaminated.

b. DECONTAMINATION. (1) Material contaminated with nonpersistent chemicals must be cleaned as soon as possible with dry-cleaning solvent or denatured alcohol, as these chemicals form corrosive acids when they combine with moisture.\*

(2) If the surface of the material is coated with grease or oil and has been in a mustard or Lewisite attack, first remove the grease or oil by wiping with rags wetted with dry-cleaning solvent. Decontaminate *unpainted metal surfaces* with a solution of noncorrosive decontaminating agent, D.A.N.C. This agent acts within 15 minutes. A second application is recommended.

(3) Decontaminate *painted surfaces* with a bleaching solution. Prepare this by mixing three parts of the bleaching powder (chloride of lime) with two parts of water by volume. The chloride of lime mixture (slurry) should not be allowed to remain on the metal parts more than

---

\*Material contaminated with Lewisite may be decontaminated with water.

1 hour; a second application should be made within a brief period after the first application to insure complete covering.

(4) After decontamination, clean the material thoroughly and prepare for use as described in paragraph 22.

(5) Do not allow chemical agents to come into contact with the skin. Burn or *preferably bury* all wiping materials used for decontamination. Mark the place where they are buried.

(6) For emergency decontamination, protective ointment, M4, may be used. The application of this ointment and the decontamination procedure is as follows:

(a) Wipe dry of all liquid contaminants and bury or burn wiping material.

(b) Spread M4 ointment well over all surfaces apparently contaminated, rub well, and allow to remain for 15 minutes.

(c) Wipe all surfaces dry of ointment.

(d) As soon as tactically permissible, disassemble the gun, clean thoroughly, oil all metal parts, and reassemble.

### 30. Antifreeze Compounds (FM 70-15)

a. During cold weather, it is necessary to guard against freezing of the water in the water jacket and circulating system of the gun. In locations where the atmospheric temperature is below 32°F., it is necessary to have antifreeze mixture available for use in the water jacket which will not freeze nor gum and yet will cool the barrel.

b. Compound, antifreeze (ethylene glycol type), is authorized for use in water jackets of machine guns for cold climates. It is satisfactory for temperatures as low as minus 60°F., when mixed with water in proper proportions. It is highly important that the proper proportions of antifreeze compound and water be maintained. Protection against freezing at temperatures as low as minus 62°F., can be obtained with a mixture consisting of 60 percent by volume of antifreeze compound and 40 percent by volume of water.

c. When the antifreeze compound and water mixture is used, it should be mixed in a container and then poured into the water jacket of the gun and the water chest to insure proper proportions and a thorough mixing of the ingredients. The strength of the solution is determined by its specific gravity, as tested by means of a hydrometer.

d. If mixing container is not available, the antifreeze compound can be poured directly into the water chest and water jacket, and water then added to the chest and water jacket until full. If this method is used, the proper amount of antifreeze compound should be computed to

produce a mixture of the required strength, so that when water is added the mixture will be correct. Cold water should not be poured into a cold chest or water jacket first, as freezing may take place before the antifreeze compound can be added. (Likewise, cold water should not be poured into a hot jacket as it might crack the parts.) If such mixing is not thoroughly accomplished the water in the mixture in chest or jacket may freeze due to lack of strength unless the gun is fired immediately and sufficiently to heat the water until mixing is complete.

## Section IV. MECHANICAL FUNCTIONING

### 31. General

A practical working knowledge of the mechanical operation of the gun is essential to insure keeping it in action during combat.

### 32. Operating Instructions

*a.* TO HALF LOAD. When loading a full belt with the cover open or closed, insert the belt in the feedway from left to right. Pull the belt through the feedway until the first round is positioned to the right of the belt-holding pawl. If using a partially consumed belt, raise the cover and position the initial round to the right of the belt-holding pawl. Close the cover if open. Pull the bolt fully to the rear and release it.

*b.* TO LOAD. Load is executed the same as half load, except that the bolt is pulled to the rear and released twice.

*c.* TO UNLOAD. Raise the cover, lift out the belt, pull the bolt to the rear and hold it, look or feel to see that there is no ammunition in the gun, lower the extractor, release the bolt, position the belt feed lever stud over the belt feed lever groove, lower the cover, and then pull the trigger.

*d.* TO CLEAR GUN. Raise the cover, remove the belt, pull the bolt to the rear and secure it in its rearmost position by engaging the extractor cam plunger in rear of the extractor feed cam, and inspect the gun to see that no ammunition is in the chamber. As an additional precaution during training periods, including field exercises and maneuvers, a wooden clearing block which protrudes a visible height above the gun will be inserted between the face of the bolt and the rear end of the barrel.

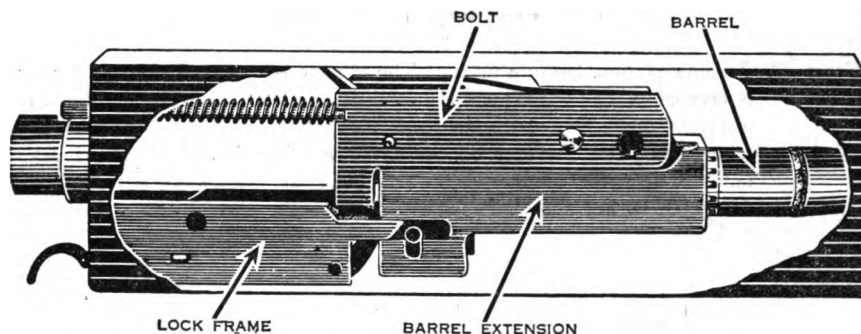
### 33. Functioning

*a.* The machine gun is a recoil-operated, automatic weapon and will fire at a rate of about 500 rounds per minute. The moving parts, while locked together at the moment of the explosion, are forced to the rear by the recoil. The movement is controlled by means of various springs,

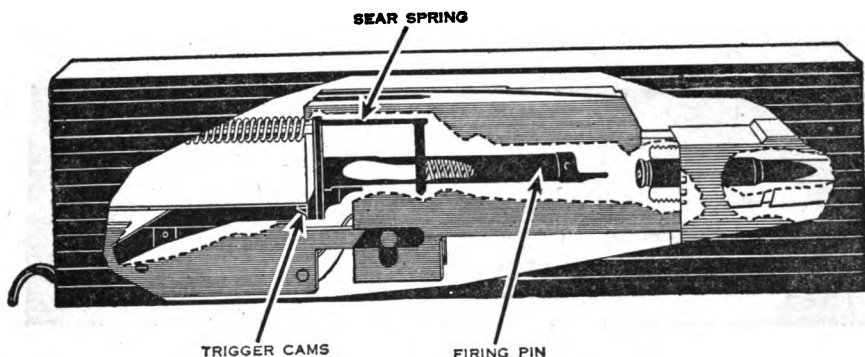
cams, and levers, and is utilized to perform the necessary mechanical operations of unlocking the breech, extracting and ejecting the empty case, feeding in the new round and loading, as well as cocking, locking, and firing the mechanism.

*Note.* The plug of the M1919A4 gun and the booster cap of the M1919A6 gun insure a positive recoil by trapping some of the expanding powder gas. This gas impinges on the muzzle of the barrel and assists in forcing the recoiling parts to the rear.

*b.* For a description of the functioning of the Browning machine gun and its parts, see figures 26 to 41, inclusive.

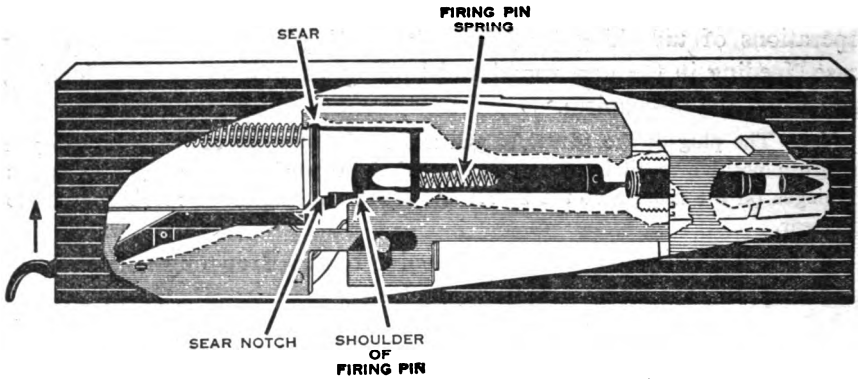


*Figure 26. RECOILING PARTS IN THE FORWARD POSITION. (The bolt, barrel, and barrel extension are the recoiling parts of the gun. The lock frame is held stationary within the receiver.)*

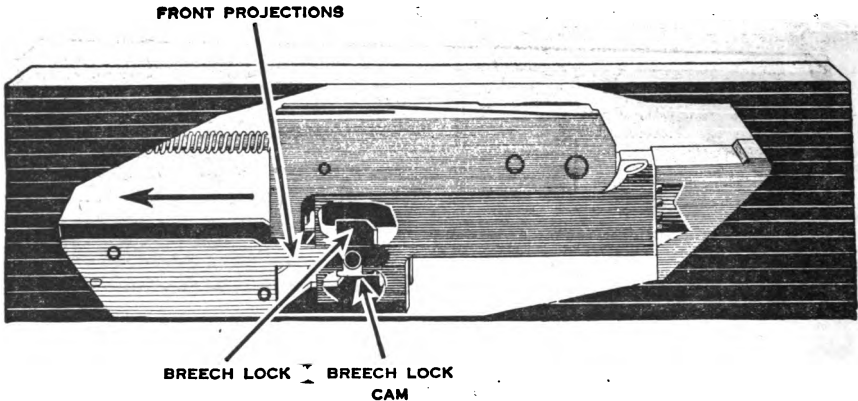


*Figure 27. Trigger Action. FIRST PHASE:* The gun is cocked ready to fire. The recoiling parts are in their forward position with one round in the chamber. The shoulder of the firing pin is engaged in the sear notch, the sear being held up by the action of the sear spring. The firing pin spring is held compressed between the sear spring pin and the firing pin spring pin. The trigger cams and the sear cams are engaged and are in position to release the firing pin when the trigger is pulled.

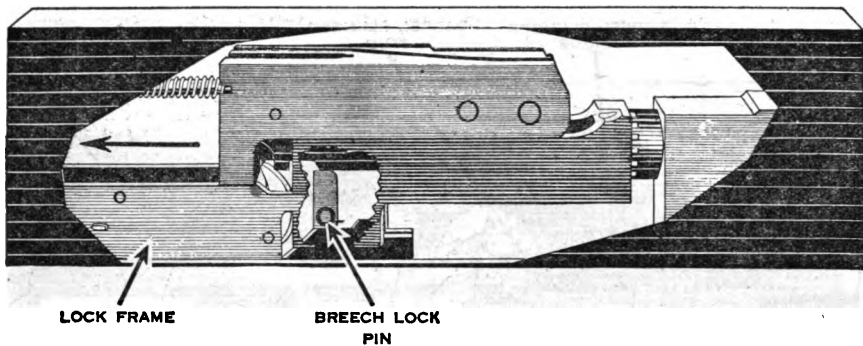




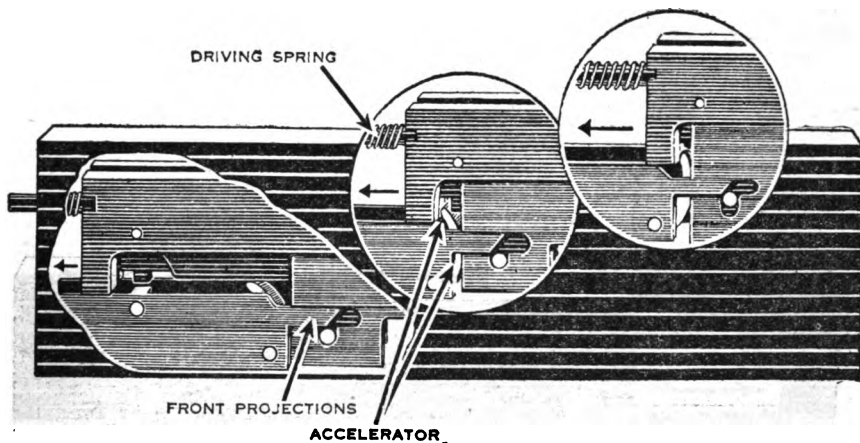
**Figure 28. Trigger Action. SECOND PHASE:** The trigger is pulled. Since the trigger is pivoted, when the rear end is raised the front end is lowered. The sear is forced down by the trigger cams through their engagement with the sear cams. The shoulder of the firing pin is released from the sear notch. The firing pin goes forward under the expanding force of the firing pin spring and strikes the primer of the cartridge.



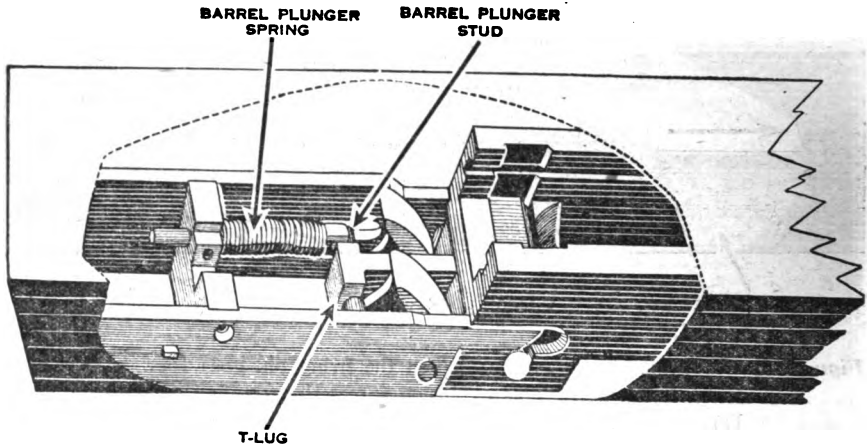
**Figure 29. Unlocking.** When the recoiling parts are in their forward position, the bolt is locked to the barrel extension and against the rear end of the barrel by the breech lock. Note that the breech lock is positioned on top of the breech lock cam and in the breech lock recess in the bottom of the bolt.



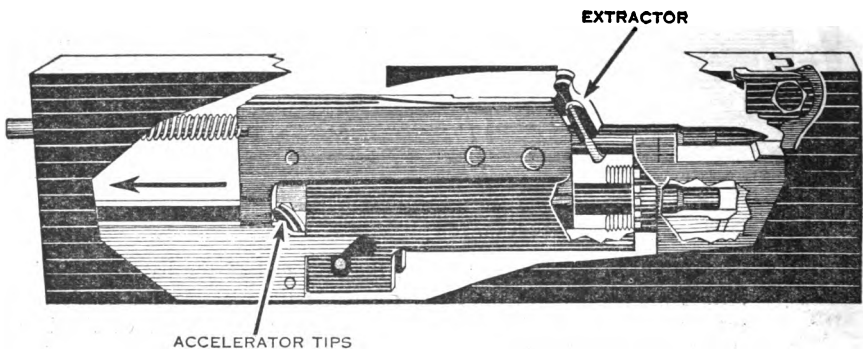
**Figure 30. Unlocking. FIRST PHASE:** When the firing pin goes forward, the cartridge is exploded. This explosion forces the recoiling parts to the rear. During the first  $\frac{5}{16}$  inch of this movement, they are locked together. During the next  $\frac{5}{16}$  inch, the bolt becomes unlocked from the barrel extension and moves away from the rear of the barrel. This unlocking takes place when the breech lock rides down off the breech lock cam, being forced down by the breech lock pin, which comes in contact with the cammed surfaces on the front projections of the lock frame. This permits the bolt to move independently to the rear. The barrel and barrel extension move only a total distance of  $\frac{5}{8}$  inch to the rear.



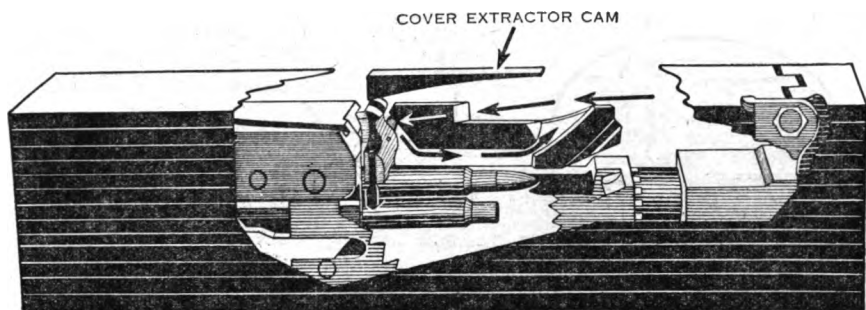
**Figure 31. Unlocking. SECOND PHASE:** When the rear end of the barrel extension strikes the accelerator, the latter rotates to the rear. As the accelerator rotates to the rear, its tips strike the lower projections of the bolt, thereby accelerating the movement of the bolt to the rear. As the bolt moves back, the driving spring is compressed against its seat in the back plate, thus producing the energy that later will drive the bolt forward. When the bolt reaches its rearmost position, it strikes the buffer plate of the shock-absorbing mechanism. The remaining momentum of the bolt is absorbed by the shock-absorbing mechanism housed in the buffer tube.



*Figure 32. Unlocking. THIRD PHASE:* As the barrel extension moves to the rear, the barrel plunger spring is compressed by the barrel plunger stud acting against the barrel plunger; the energy thus produced later will help drive the barrel and barrel extension forward. The barrel plunger spring is held compressed by the claws of the accelerator which engage the T-lug and lock the barrel extension to the lock frame. The accelerator stop prevents the accelerator from turning too far to the rear.

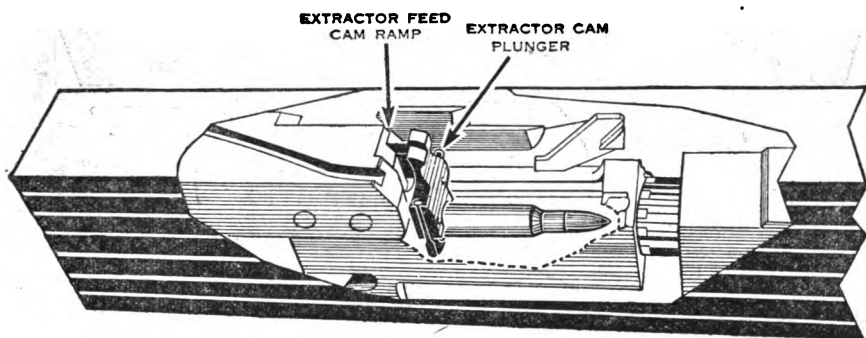


*Figure 33. Extraction and ejection. FIRST PHASE:* As the recoiling parts move to the rear, the extractor starts removal of a new round from the belt. As the bolt starts its independent rearward movement the empty case, held by the T-slot, starts withdrawal from the chamber. The cover extractor spring exerts a downward pressure on the extractor so that it cannot lose its grip on the cartridge.

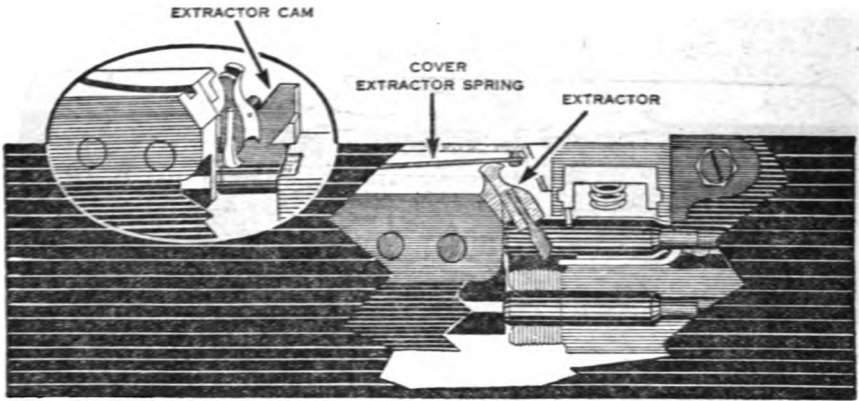


*Figure 34. Extraction and ejection. SECOND PHASE:* As the bolt moves to the rear, the extractor cam plunger passes over the top of the extractor cam and rides along the extractor feed cam until it is forced in by the beveled surface of the extractor feed cam. At this point the cover extractor cam exerts a downward pressure on the extractor and, as the bolt continues to the rear the extractor cam plunger springs out below the notch in the extractor feed cam.

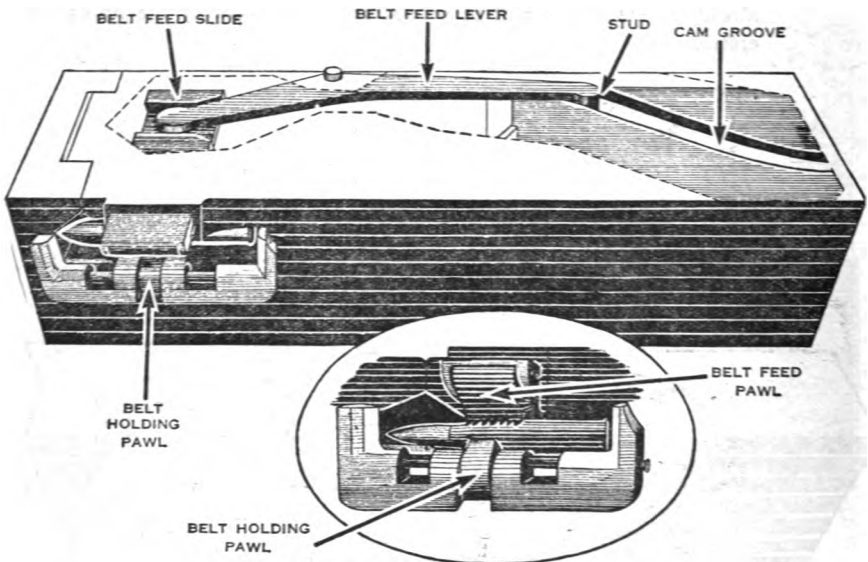
*THIRD PHASE:* After the bolt reaches its rearmost position, it starts forward under the expanding force of the driving spring. The extractor cam plunger, moving down behind the ramp on the extractor feed cam, carries with it the extractor, which forces the new round down into the T-slot. At the same time, if the empty case in the T-slot has not already fallen out, it will be pushed from the T-slot by the tip of the ejector.



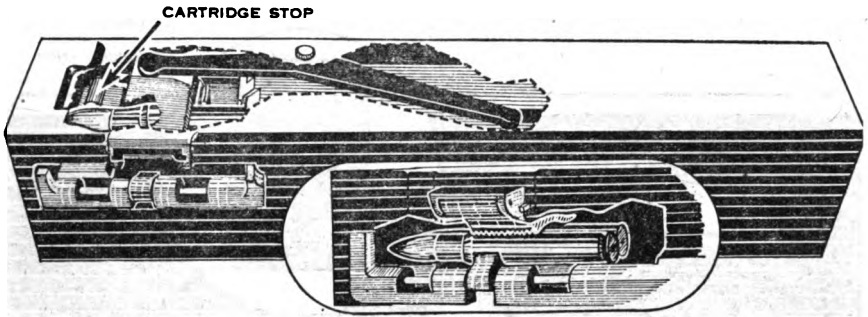
*Figure 35. Loading. FIRST PHASE:* After the extractor cam plunger clears the bottom of the extractor feed cam ramp and the bolt is moving forward, the new round is held in line with the chamber by the extractor and ejector.



**Figure 36. Loading. SECOND PHASE:** The bolt continues forward. The extractor rises as the extractor cam plunger rides up on the extractor cam. As the extractor rises, the ejector is forced outward by the cartridge case into the half-moon recess of the barrel extension, and releases its hold on the cartridge case. The bolt moves to its forward position, fully seating the new round in the chamber. At the same time, the extractor rises over the extractor cam and, with the ejector, grips the next round in the belt. It is now being pressed down by the cover extractor spring, ready to extract the round from the belt when the bolt again moves to the rear.



**Figure 37. Feeding. FIRST PHASE:** As the bolt moves to the rear, the stud on the rear end of the pivoted belt feed lever moves to the right in the cam groove, forcing the opposite end of the lever, and with it the belt feed slide, to the left. The belt feed pawl rides over the first cartridge in the belt and springs out to the left of the cartridge under the action of the feed pawl spring. The cartridge, together with the belt, is held in position by the belt-holding pawl.

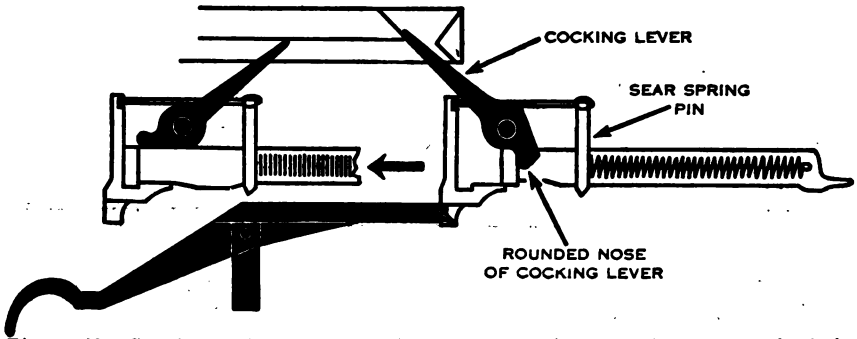


①

②

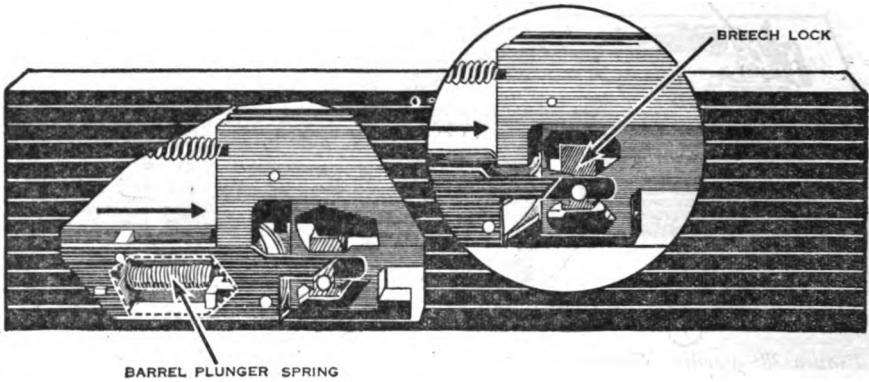
**Figure 38. Feeding. SECOND PHASE:** As the bolt goes forward, the stud on the rear end of the pivoted belt feed lever moves to the left in the cam groove, forcing the opposite end of the lever, and with it the belt feed slide, to the right. The belt feed pawl carries the first cartridge to the right against the cartridge stops, ready to be gripped by the extractor. (See ①.) As the belt moves to the right, the next cartridge is carried over the belt-holding pawl. The belt-holding pawl is forced down as the cartridge passes over it, but, after the cartridge has passed, rises behind the cartridge under the action of the belt-holding pawl spring, and holds the cartridge in position until engaged by the belt feed pawl. (See ②.)

*Note.* In the event the extractor fails to withdraw the leading round from the belt, the finger of the belt feed pawl, riding on the top of this unextracted round, will hold the pawl in a raised position where it cannot engage the left of the next cartridge. Thus double feeding is impossible.

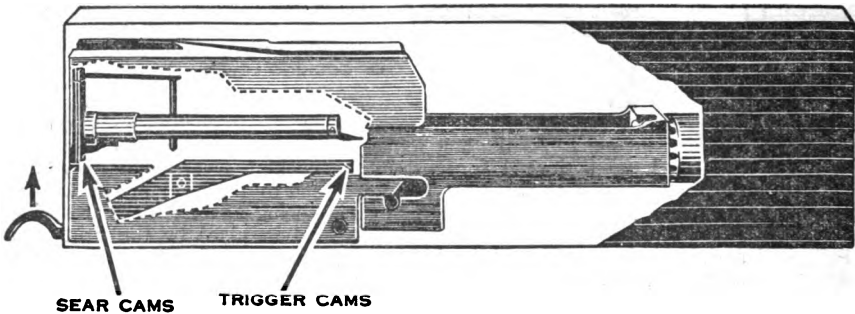


**Figure 39. Cocking action. a.** As the bolt moves to the rear, the upper end of the cocking lever is forced forward in the cocking lever recess, pivoting the rounded nose to the rear. The lower end of the lever brings with it the firing pin, compressing the firing pin spring against the sear spring pin. (The front end of this spring is held in place by the firing pin spring pin.) The shoulder of the firing pin engages the notch in the sear, which, freed from the trigger cams, is pulled upward by the action of the sear spring. During the initial movement of the bolt to the rear, the sear cams are disengaged from the trigger cams. The shoulder of the firing pin, riding on the sear platform, prevents the sear from rising until the shoulder is directly over the sear notch. Then, pulled up by the action of the sear spring, the sear rises and the sear notch engages the shoulder of the firing pin.

**b.** As the bolt moves forward, the upper end of the cocking lever is rotated backward, causing the rounded nose to pivot forward, away from the rear of the firing pin. If the firing pin is prematurely released by the rounded nose of the cocking lever and eased forward so that the striker cannot contact the cartridge primer until after the breech has been locked.



**Figure 40. Locking.** As the bolt goes forward, the front of its lower rear projections strikes the accelerator, tripping it and rotating it forward. This disengages the barrel extension from the lock frame and releases the barrel plunger spring. The barrel extension and the barrel are moved forward by the force of the bolt acting against the accelerator and by the expansion of the barrel plunger spring. As the recoiling parts are moved forward, the breech lock rides up on the breech lock cam into the breech lock recess in the bottom of the bolt. This locks the bolt firmly to the barrel extension and against the rear of the barrel.



**Figure 41. Automatic Firing.** If the trigger is held raised, the trigger cams engage the sear cams each time the bolt moves forward, forcing the sear down, and releasing the firing pin. The gun thus fires automatically; repeating the operations of functioning already described, as long as the trigger is held raised. The release of the firing pin takes place about  $\frac{1}{16}$  inch before the recoiling parts reach the forward position, *but after the breech is locked.*

## Section V. STOPPAGES AND IMMEDIATE ACTION

### 34. Stoppages

For combat efficiency, the machine gunner must understand the causes of common stoppages, observe a definite routine to prevent the cause, and be able to act promptly to *reduce* a stoppage should one occur.

### 35. Causes of Stoppages

The following table gives the causes of common stoppages:

Nature of stoppage	Usual causes	Other causes
Failure to feed...	Defect in ammunition belt. Defect in feed mechanism.	Empty loop in belt. Improperly loaded belt. Short round.
Failure to load...	Broken part, or obstruction in the T-slot or chamber. Separated (ruptured) case.	Thick rim. Bulged round. Set back primer. Thin rim
Failure to fire...	Defective part in firing mechanism. Defective ammunition.	Dirt causing faulty engagement.
Failure to function freely	Excessive friction caused by— Dirty parts. Lack of proper lubrication. Tight head space. Tight packing.	Burred parts. Maladjustment of buffer assembly. Weak driving spring. Loose bullets. Broken barrel extension or lock frame. Too much or too heavy oil for cold weather.

### 36. Prevention of Stoppages

a. Stoppages will be kept to a minimum if the gunner has a practical working knowledge of his weapon and applies the points which should be observed before, during, and after firing. The following table will serve as a guide during instruction in stoppages or immediate action:

Stoppages	Method of preparation for instruction in immediate action and stoppages
1. Misfire due to defective primer.	1. Place a dummy cartridge in the belt.
2. Short round.	2. Place a short round in the belt.
3. Bulged round.	3. Insert bulged round in the belt.
4. Tight loop in the belt. <sup>1</sup>	4. Do not prepare.
5. Empty loop in belt.	5. Leave an empty loop in the belt.
6. Stretched or torn belt. <sup>1</sup>	6. Do not prepare.
7. Thin rim, permitting the nose of the bullet to drop below the chamber. <sup>1</sup>	7. Do not prepare.
8. Belt improperly loaded.	8. Pull a cartridge partially out of the belt.
9. Battered or thick rim of cartridge.	9. Place a battered or a thick-rimmed cartridge in the belt.
10. Failure to remove round from chamber.	10. Place a dummy cartridge with rim filed off in the chamber.
11. Set-back primer. <sup>1</sup>	11. Do not prepare.

<sup>1</sup>Not prepared for instruction in immediate action.



Stoppages (Contd)	Method of preparation for instruction in immediate action and stoppages. (Cont'd)
12. Separated case which is removed from the chamber by the new found when the bolt is pulled to the rear.	12. Drive the front portion of a cartridge securely on a dummy cartridge. Pull the bolt to the rear and place the cartridge properly on face of the bolt. Ease the bolt forward.
13. Separated case, which stays in the chamber when the bolt is pulled to the rear. (Do not set up loose head space.)	13. Insert the front end of a separated case in the chamber, and load.
14. Bullet loose in the cartridge case. Cartridge case extracted from belt but bullet remains in belt. <sup>1</sup>	14. Do not prepare.
15. Short or broken firing pin.	15. Assemble the bolt with a defective firing pin or place 5 or 6 successive range-dummy cartridges in the belt for instruction in immediate action.
16. Weak or broken firing pin spring.	16. Same as 15.
17. Faulty engagement of firing pin and sear notch.	17. Same as 15.
18. Broken sear spring.	18. Same as 15.
19. Belt feed lever pivot out, worn, or broken.	19. Assemble the cover with defective part.
20. Bent or worn belt feed lever.	20. Same as 19.
21. Belt feed pawl spring out or weak.	21. Remove belt feed pawl spring.
22. Belt feed pawl pin out or partially out.	22. Remove belt feed pawl pin.
23. Cover extractor spring out or weak.	23. Remove cover extractor spring.
24. Belt feed lever bent up (stud on lever jumps out of cam groove).	24. Assemble with defective part.
25. Damaged extractor.	25. Same as 24.
26. Belt-holding pawl out or spring weak.	26. Remove belt-holding pawl.
27. Broken extractor or ejector.	27. Assemble bolt with defective part.
28. Broken or damaged T-slot, causing misalignment and buckling of cartridge as bolt moves forward or failure to extract. <sup>1</sup>	28. Do not prepare.
29. Weak ejector spring causing misalignment and buckling of cartridge as bolt goes forward.	29. Assemble with defective part.
30. Broken barrel extension or lock frame.	30. Assemble with defective part.
31. Tight packing causing barrel to bind.	31. Pack and tighten the muzzle gland excessively. <sup>2</sup>
32. Defective trigger mechanism—(Defective trigger mechanism may cause the gun to begin firing as soon as it is loaded or to continue to fire when the trigger is released. To remedy: unlatch the cover or twist the belt, unload, disassemble the gun, and replace the defective part or parts.) <sup>1</sup>	32. Do not prepare.

<sup>1</sup>Not prepared for instruction in immediate action.

<sup>2</sup>Applies to M1917A1 gun only.

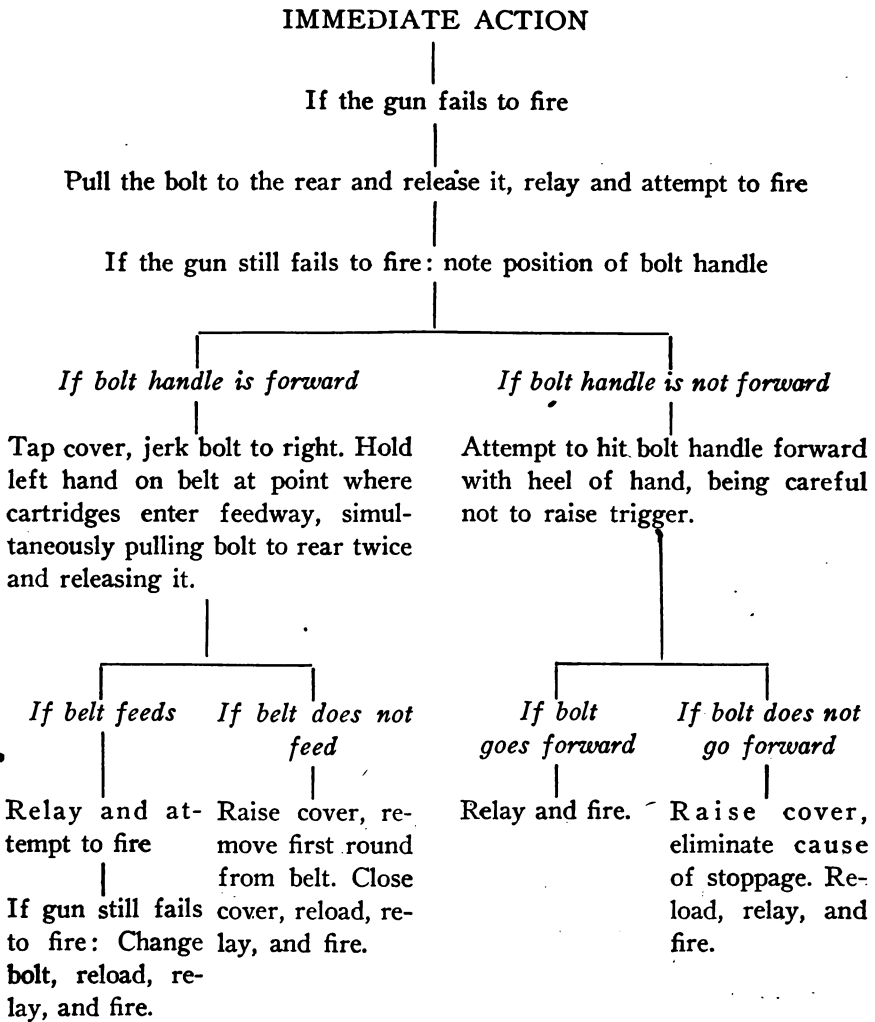
b. Procedure to be followed before, during, and after firing:

	Before	During firing and during temporary cessation	After
Bore .....	Make sure it is clean.		Clean and lightly oil.
Moving parts, including feed mechanism.	Oil and test for worn or broken parts. See that parts function without excessive friction.	Lubricate the working parts. Observe the functioning of the gun to anticipate failures.	Remove, inspect, clean, and oil bolt, lock frame, barrel extension, and barrel; release firing pin.
Head space adjustment.	Test adjustment and correct if necessary. Test strength of barrel locking spring.	Test immediately if a separated case occurs, and tighten if necessary. Test during cessations.	Adjust correctly. Examine barrel locking spring.
Rear sight and windage gauge.	See that sight is in good mechanical condition, clean and free from grease. Set sight at 700, windage gauge at zero.	Keep properly set.	Clean and oil. Set sight at 700, windage gauge at zero.
Mounts: Tripod .....	See that tripod is set firmly; legs, clamps, and clamping handle are <i>tight</i> ; traversing and elevating mechanism are in good condition and properly positioned to facilitate manipulation.	Keep firmly set. Examine during cessations.	Clean and oil.
Bipod .....	Tighten upper and lower thumb screws.	See that thumb screws are tight and extensions are at proper length.	Clean and oil.
Belts and ammunition.	Check supply of ammunition. Inspect ammunition. Keep belts dry and out of sand and dirt.	Keep belt in line with feed opening.	Clean, repair, and refill all belts. Segregate live rounds from empty cases. Inspect ammunition.
Oil .....	See that the oil can is full. See that they are clean and oiled. See that kits are complete, and test all newly drawn parts for fit.	Keep available.	Refill oil can. Check, replace damaged or missing parts.
Spare parts and tools.			Clean and oil. Test replaced parts for fit.
Muzzle gland packing, muzzle end, (M1917A1).	Check packing. Add or remove packing if necessary.	Check packing. Add or remove packing if necessary.	Check packing. Add or remove packing if necessary.
Packing, breech end, (M1917A1).	Examine for leakage or excessive friction.	Watch for leakage.	Examine and replace, if necessary.
Water (M1917A1 gun).	See that water jacket is filled, that water plugs and hose connections are tight.	Refill if necessary.	Empty all water into water chest. Wash out or flush water jacket if muddy or dirty water has been used.
Shoulder rest (M1919A6 gun).	Tighten wing nut.....	Keep tight.	Clean.

### 37. Reduction of Stoppages

a. **IMMEDIATE ACTION.** Immediate action is performed by No. 1, the gunner. No. 2, the assistant gunner, will be alert to assist No. 1. All members of the squad will be trained to function as No. 1 and No. 2.

b. **PROCEDURE.** The procedure prescribed in immediate action is based on the frequency with which the various types of stoppages occur. Prompt execution of this procedure by the gunner will enable him to remedy the majority of stoppages immediately without attempting to analyze the cause. The procedure for immediate action is shown in the following diagram:



**Notes.** 1. If the procedure outlined above does not place the gun in action, the gunner must inspect the feed mechanism and the working parts of the gun, to include inspection of the chamber for a ruptured case, in order to locate and reduce the stoppage.

2. If the bolt stops just short of "home," it frequently can be pushed fully forward and firing continued without application of immediate action. **Caution:** Release the trigger before pushing the bolt forward.

3. Stoppages caused by a defective feed mechanism can sometimes be remedied temporarily by pulling the belt to the right with just sufficient force to assist the feed mechanism in positioning the leading round.

4. Immediate action is not complete until the gun has been relayed and fired.

**c. UNUSUAL TYPE STOPPAGES.** If the gun fails to fire under the application of immediate action, it is probable that the stoppage is of the unusual type and will require a detailed inspection for the cause of the stoppage.

**d. RECURRENCE OF STOPPAGE.** If a stoppage recurs several times, eliminate the cause of the stoppage at the first opportunity.

**e. INSPECTION OF THE FEED MECHANISM.** The inspection of the belt feed lever and slide should be made as follows:

(1) With the bolt forward, lower the cover, making sure that the stud on the belt feed lever is in the cam groove in the top of the bolt. Examine the belt feed lever for excessive wear at the pivot and stud. Also see that the stud projects a sufficient distance beneath the cover to insure that it is positively positioned in the cam groove in the top of the bolt when the cover is closed. Replace the defective parts.

*Note.* If there is excessive play in the belt feed lever and slide, the cartridge may not be correctly positioned and the extractor may strike the base of the cartridge, force the bullet into the case, and cause a short round. The resulting failure to feed is thus caused by a worn or bent belt feed lever, or a defective slide. The base of such a cartridge will show evidence of having been hit by the extractor.

(2) If the slide positions properly and no excessive play exists, examine the cover extractor spring; the belt feed pawl, spring, and pin; the belt-holding pawl and spring; the extractor, including the ejector; the extractor cam plunger and spring, and the T-slot, to see that these parts are in their proper positions and in good condition and that the springs are sufficiently strong to actuate the parts properly.

**f. TO REMOVE A RUPTURED CARTRIDGE CASE.** A ruptured cartridge case in the chamber prohibits the entrance of the succeeding round. *The ruptured cartridge extractor, Mk. IV, is used to remove the ruptured case.* To use the ruptured cartridge extractor, open the cover, draw the bolt handle to the rear and *hang the bolt* by engaging the extractor cam plunger in the notch in the rear of the extractor feed cam. Insert the nose of the ruptured cartridge extractor in the chamber, handle up; push

it forward to seat it firmly in the separated case, then pull backward on its handle. The ruptured case should then be removed from the ruptured cartridge extractor so that the cartridge extractor will again be ready for use. To do this, unscrew the end of the ruptured cartridge extractor, take off the ruptured case, and screw the end on again.

g. TO REMOVE A ROUND FROM T-SLOT. Pull the bolt to the rear. Attempt to raise the extractor.

(1) *If extractor can be raised.* The round may fall out of the T-slot. If the round does not fall out, *remove it with the combination tool.* If the round is above the bolt handle slot, insert the screw driver end of the tool through the slot and under the rear of the cartridge and pry it up. If the round is below the slot, place the screw driver end of the tool through the top of the receiver into the cannellure of the cartridge and drive it down.

(2) *If extractor cannot be raised.* If the cartridge is engaged by the extractor and by the ejector, and is rigidly stuck in the T-slot at any point which positions the lower end of the ejector below the top edge of the barrel extension, it will not be possible to raise the extractor without raising the cartridge, as the wall of the barrel extension will not permit the ejector to move outward around the cartridge. If the cartridge is stuck above the bolt handle slot, hold the bolt fully to the rear. Insert the screw driver end of the combination tool through the bolt handle slot and under the rear end of the cartridge. Pry the cartridge, still engaged by the extractor, upward out of the T-slot. Then raise the extractor, and the cartridge will fall out. If the cartridge is below the bolt handle slot, insert the screw driver end of the combination tool through the opening *in the bottom* of the receiver. Drive the cartridge and the extractor upward out of the T-slot, then raise the extractor and the cartridge will fall out.

h. TO REMOVE A CASE FROM CHAMBER. The cleaning rod is used to remove a case which has not been extracted from the chamber by the bolt. To remove the case from the chamber, pull the bolt fully to the rear and hold it. Remove the round which is engaged in the T-slot. Grasp the cleaning rod about 6 inches from the handle end, insert it in the muzzle, and force the case from the chamber. Care should be taken not to damage the face of the bolt by striking it after the rod has been pushed through the bore.

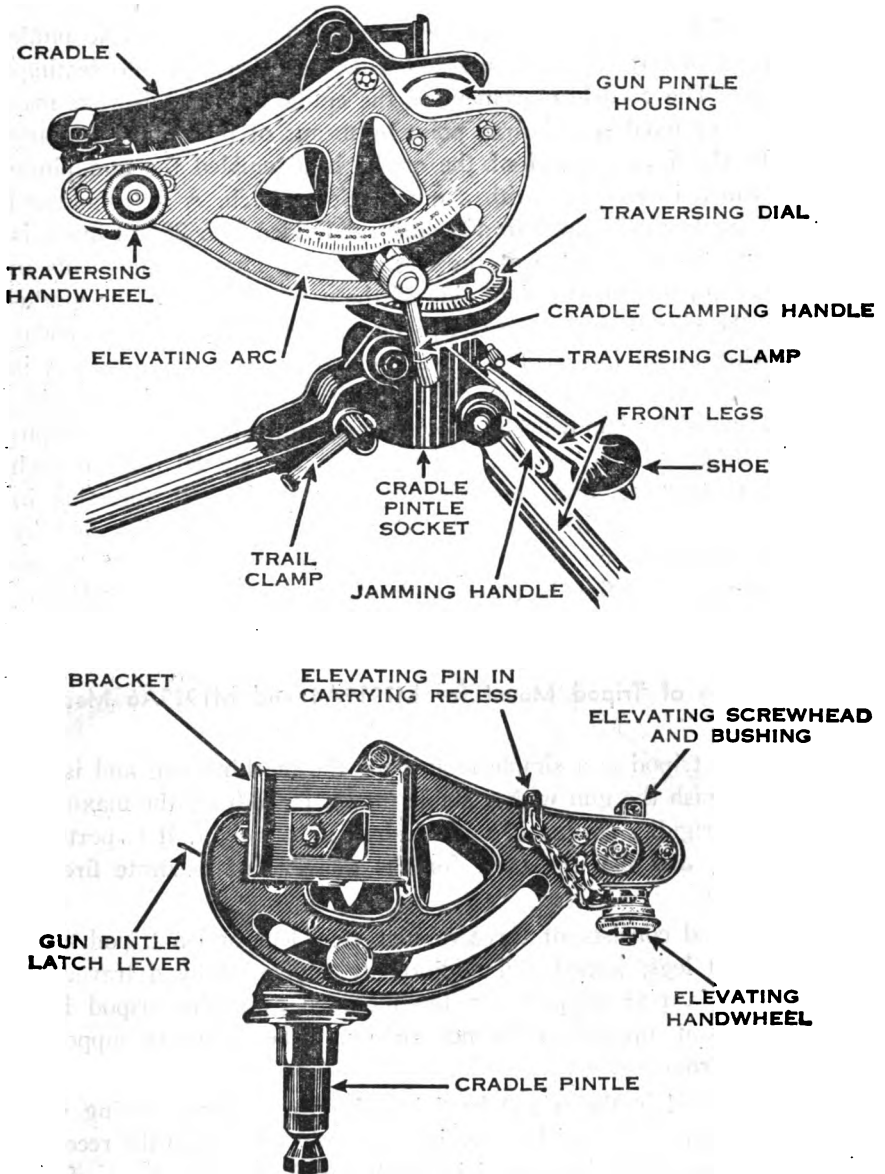
## Section VI. MOUNTS

### 38. Tripod Mount for M1917A1 Machine Gun

Use of the M1917A1 tripod necessitates the addition of a gun pintle which is semipermanently assembled to the gun by a bolt which passes through the hole in the receiver originally intended for the trunnion pin.

**39. Description of M1917A1 Tripod Mount (fig. 42)**

a. The central member of the tripod is a socket with three projecting lugs. Attached to the socket are three legs which may be clamped independently in various positions, thus providing a level mount on uneven or sloping ground.



*Figure 42. M1917A1 tripod and cradle.*

*b.* The cradle pintle fits into the socket and turns in it. The traversing clamp prevents the pintle from being pulled out of the socket and controls the ease of rotation of the pintle. The traversing dial seated on top of the socket may be rotated in its seat. The dial is graduated to 3,200 mils in both directions from zero and is subdivided in 25-mil units. The traversing dial may be secured in any desired position by means of the traversing dial clamp. The cradle is assembled to the top of the pintle by means of the cradle trunnion studs which are threaded into seatings in the yoke. The verticle movement of the cradle around this yoke may be adjusted or fixed at a desired point by means of the cradle-clamping handle. In the forward end of the cradle is assembled the gun pintle housing which is equipped with a quick release latch. A mil-graduated scale reading from 500 to 0 to 400, and subdivided into 25-mil units, is etched upon the upper edge of the elevation arc. Large adjustments in elevations are made on the right side of the cradle by use of the graduations on the elevation arc, the sharp edge of the cradle-clamping collar body serving as an index. The elevating and traversing mechanism is housed in the rear end of the cradle frame. Elevating and traversing screws, actuated by handwheels, provide mechanical means for manipulation in single mil increments. Up to approximately 50 mils in each direction, in traverse, and approximately 90 mils in each direction in elevation, motion may be noted by means of the audible click and by noting the readings on the respective micrometer scales. Due to the possibility of lost motion in these mechanisms, care should be taken to note whether the gun actually moves each time the mechanism is actuated.

#### **40. Description of Tripod Mount for M1919A4 and M1919A6 Machine Guns (fig. 43).**

*a.* The M2 tripod is a simple mount for the machine gun and is designed to furnish the gun with a stable mount embodying the maximum strength and rigidity consistent with desired light weight. It is portable, easily packed, and may be used for the delivery of accurate fire on ground targets.

*b.* The tripod consists of three tubular steel legs and a tripod head. The two trail legs, joined and additionally supported by a traversing bar, serve as a rear support for the mounted gun. The tripod head furnishes a front support for the mounted gun, it being in turn supported by the short front leg.

*c.* Incorporated in the tripod head is a bronze bushing, mating with the tapered steel pintle which is semipermanently secured to the receiver of the gun. The pintle is secured in the bushing by engagement of the pintle latch of the tripod in its corresponding annular, upper grove of

the pintle. The pintle latch is spring actuated and is seated in a housing on the lower right surface of the tripod head.

d. The traversing bar provides a rear support for the mounted gun, the traversing slide of the elevating and traversing mechanism mating with the bar. A device for measuring or establishing horizontal angles is incorporated in the scale engraved on the traversing bar. This scale is divided into 100-mil major divisions and 5-mil minor subdivisions, up to 450 mils to the left and 425 to the right.

e. The traversing bar has sliding sleeve devices at each end, the sleeves moving along the trail legs when mounting and dismounting the tripod. Position stops are incorporated on the trail legs, positively positioning the traversing bar in both the mounted and dismounted positions of the tripod. The traversing bar sleeve latch, mounted on the right trail leg, secures the traversing bar in its proper position when the tripod is mounted. Recent mounts are provided with an adjustable traversing bar which permits lengthening of the bar, spreading the two rear legs further apart when latched, and thereby making the mount more rigid.

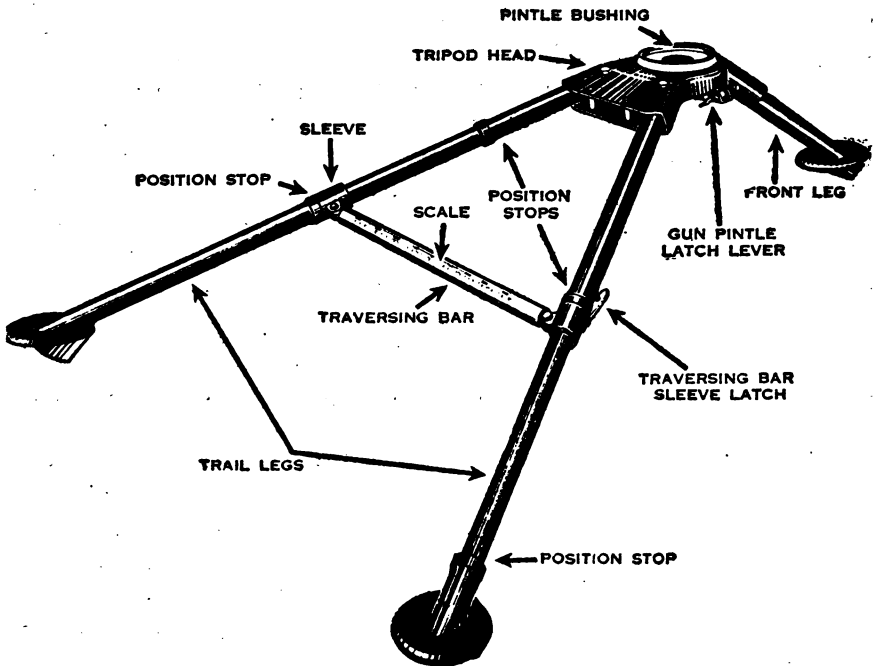


Figure 43. M2 tripod.

#### 41. Elevating and Traversing Mechanism of M2 Mount (fig. 44)

a. The elevating and traversing mechanism is not technically a part



of the gun, although it is secured to the receiver by a bolt through the head of this mechanism and the elevating bracket of the gun.

b. The elevating and traversing mechanism consists of an upper elevating screw; a lower elevating screw; an elevating handwheel assembly secured to the head of the lower elevating screw; a housing mating with the lower elevating screw; a traversing slide, and a traversing screw, handwheel, and micrometer. This mechanism incorporates a mil click device.

(1) The upper elevating screw terminates at its upper end in an offset head which incorporates a recess. This recess is for the bolt which assembles the entire elevating and traversing mechanism to the gun. The mechanism is properly assembled to the gun when the offset head points to the rear, thus permitting the mechanism to be folded to the rear and seated in its recess in the grip. The upper elevating screw is externally threaded to mate with the internal threads of the lower elevating screw. It is equipped with a longitudinal slot in which is seated an engraved scale to indicate plus or minus increments of elevation of the gun. It is subdivided into 50-mil graduations and is read by noting the position of the upper edge of the lug of the click ring which moves in the longitudinal slot as the elevating handwheel is rotated.

(2) The lower elevating screw is threaded internally to mate with the externally threaded upper elevating screw and is threaded externally to mate with the lower elevating screw housing. Secured to its upper end is the elevating handwheel assembly.

(3) The elevating handwheel assembly incorporates a mil click device. The circumference of the handwheel has 10 notches, each notch indicating a 5-mil increment of elevation. Engraved on the upper surface of the handwheel is a mil scale which is read directly from the indicator attached to the click ring. This 50-mil scale is divided and numbered in 5-mil major divisions and single-mil subdivisions. The click ring which is carried in the elevating handwheel is prevented from rotating with the handwheel by the engagement of a lug in the longitudinal slot of the upper elevating screw.

(4) The lower elevating screw sleeve is threaded internally to engage the external threads of the lower elevating screw. This sleeve carries at its front portion a spring actuated plunger which prevents disassembly of the lower elevating screw from its sleeve. At the upper rear portion of the lower elevating screw sleeve is the male portion of a swivel joint, attaching the traversing slide to the elevating and traversing mechanism.

(5) The traversing slide assembly consists of the traversing slide lock lever, the traversing slide lock lever screw, the traversing slide locking screw and washer. Attachments of the lock lever to the locking screw

is provided for by a spline assembly, which the lock lever screw holds secure. Adjustment of the locking screw should be such that when it is in firm contact with the traversing bar, the lever will be about 45° above the right horizontal position. Traversing slides of recent manufacture have a small shakeproof washer under the traversing slide lock lever screw to prevent its loss.

(6) Movement of the gun in elevation is accomplished by rotation of the elevating handwheel, the traversing slide being in firm contact with the traversing bar, with the traversing slide lock lever engaged. (When firing on rapidly moving ground targets, the traversing slide lock is not engaged, although the traversing slide must be retained in firm contact with the traversing bar.)

(7) The M1919A4 machine gun may be traversed 50 mils or less by using the traversing handwheel; over 50 mils, by moving the gun right or left as desired, the traversing clamp being disengaged from the

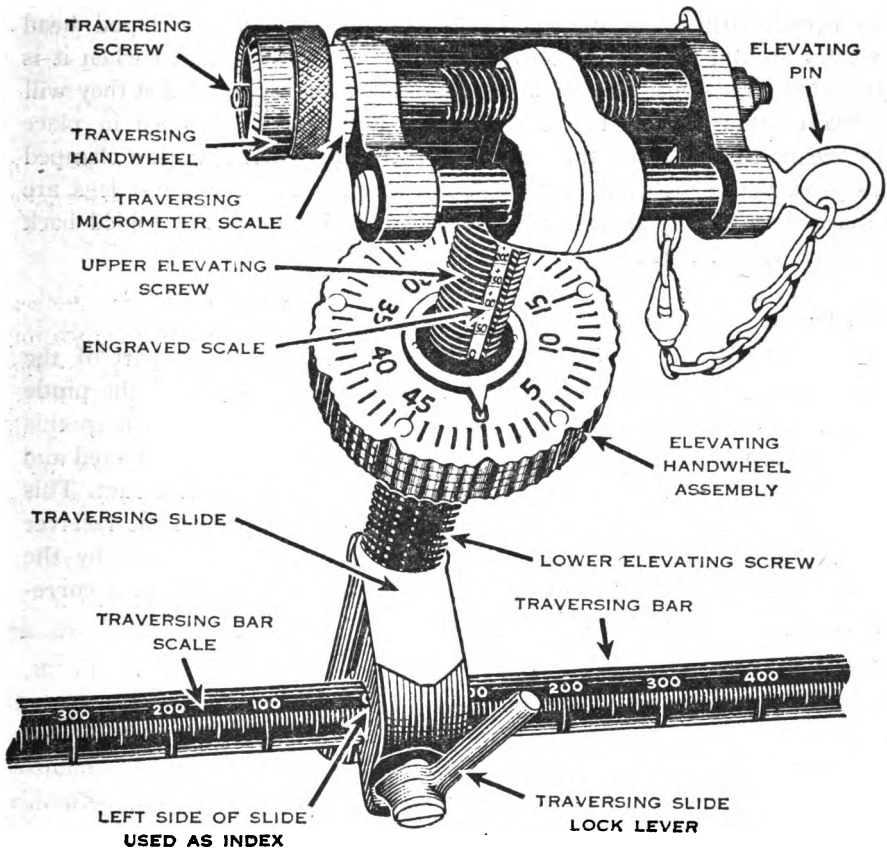


Figure 44. Elevating and traversing mechanism of the M2 mount.

traversing bar, but with the traversing slide retained in firm contact with the traversing bar.

c. The maximum amount of search, using the elevating mechanism, is 465 mils, 265 mils above zero graduation, and 200 mils below. Maximum traverse, using the traversing handwheel, is 60 mils using the traversing bar it is 875 mils, 450 right and 425 left from zero graduation.

*Note.* The above figures on search and traverse may vary slightly for different sets of equipment.

#### **42. Bipod Mount for M1919A6 Machine Gun**

The M1919A6 gun is equipped with a bipod leg assembly which is attached to the front barrel bearing and held in place by a lock ring. (See fig. 7.) The bipod leg tubes can be folded back along the barrel or placed in a position at right angles to it. Each tube has an extension which can be pulled out to raise the position of the muzzle. On bipod of late construction the wing nut and clamp are on the sliding leg assembly, to permit adjustment of bipod legs with one hand. The bipod head rotates around the bearing so that the gun will not be canted when it is mounted on a slope. The bipod leg tubes are so constructed that they will remain either vertical or parallel to the barrel when clamped in place by means of the upper thumb screws. The tube extensions are clamped in place by means of the lower thumb screws. Two fixed rest legs are attached to the bipod head for use when the leg tubes are folded back parallel to the barrel.

#### **43. Pintle**

The pintle of the machine gun, although technically not a part of the gun, is assembled thereto by a bolt through the trunnions of the pintle and the trunnion hole of the receiver of the gun. Failure to keep this bolt reasonably tight will produce inaccurate fire. The pintle is tapered and mates with the corresponding tapered pintle bushing of the mount. This tapered pintle thus serves as a tight bearing union between the receiver of the gun and its mount. The pintle is secured in its mount by the engagement of a spring actuated pintle latch of the mount in a corresponding annular groove of the pintle.

## CHAPTER 2

### TRAINING FOR PLACING MACHINE GUNS IN ACTION

---

#### Section I. GENERAL

#### 44. General

*a.* The object of gun drill is to train the squad as a team to put its machine gun into action with precision and speed.

*b.* Teamwork is improved by rotation in duties during drill so that each member of the squad becomes familiar with the duties of every other member, particularly with the more detailed actions of Nos. 1, 2, and 3, who constitute the gun crew.

*c.* Precision is attained by strict adherence to the prescribed procedure. Exactness is the first objective; when it has been developed, speed is emphasized.

*d.* No. 1 repeats all commands of the squad leader.

*e.* When signals are used, No. 2 transmits them to No. 1.

*f.* At the completion of any ordered movements, except **OUT OF ACTION**, the member of the team responsible for its correct execution calls, "Up," and No. 2 signals: **READY**. At the completion of **OUT OF ACTION**, No. 1, only, calls, "Up." No. 2 does not signal **READY** in this instance.

*g.* Unless otherwise stated, individuals move from one position to another at a run.

*h.* In the field, the drill procedure of movements, such as **ACTION** and **OUT OF ACTION**, will be followed as closely as the situation will permit.

#### 45. To Change Numbers and Duties During Drill

*a.* The command is **FALL OUT ONE (TWO, THREE)** (or any member of the squad). The individual mentioned springs to his feet and moves rapidly to the position formerly occupied by the highest numbered individual. Each member of the squad, higher numbered than the individual mentioned, successively takes the position of the next lower numbered individual. Each man as he takes his new position calls out his new number.

b. The command may be given to the squad when in any formation or during the progress of a movement.

## Section II. GUN DRILL WITH M1917A1 MACHINE GUN

### 46. To Secure Equipment and Form for Gun Drill

a. The command is **SECURE EQUIPMENT**. Men secure equipment as follows:

Personnel	Equipment*
Squad leader.....	Clinometer (habitually attached to the belt). Spare barrel. Cleaning rod.
No. 1 .....	Tripod.
No. 2 .....	Gun (with the flash hider and the steam-condensing device attached). Asbestos mittens. Canvas gun cover.
No. 3 .....	1 box of ammunition. 1 chest of water. 2 ammunition bags.
No. 4 .....	1 chest of spare parts. 1 box of ammunition. 2 ammunition bags.
All higher numbers..	Each, 2 boxes of ammunition. 2 ammunition bags.

\*Dependent upon current T/O & E.

b. Having secured equipment, the squad forms in column with five paces between men, No. 1 five paces from and facing the squad leader. Each man grounds his load and takes the prone position as follows (fig. 45):

- (1) No. 1, with the tripod to his right, the trail leg to the rear.
- (2) No. 2, with the gun to his front, the muzzle to the left, windage knob up, resting on the canvas gun cover.
- (3) No. 3, with the chests to his front, one foot apart, the ammunition box on the right, latch to the front; the water chest on the left, lid to the front.
- (4) Other members, if present, place their ammunition or spare parts chests to their front, one foot apart, the latches of the ammunition boxes to the front.

### 47. To Examine Equipment

A thorough examination of the equipment is made at the beginning and at the end of each drill period. Upon a change of numbers, such examina-



Figure 45. Position of squad leader and gun crew after securing equipment and forming for gun drill.

tion is made, without report, as will determine that the equipment is in proper condition for execution of the drill. The same procedure is followed in drill and in the field, except that in drill, water and live ammunition are assumed.

a. The equipment being grounded, the squad leader commands: EXAMINE EQUIPMENT BEFORE FIRING. At this command, each man, keeping well down, examines his equipment as indicated below:

(1) *No. 1 examines the tripod and sees that—*

(a) The trail leg is adjusted so that the gun, when mounted, will be at the proper height for the normal position, with the traversing dial level.

(b) The front legs and the trail are folded closely and clamped, and the strap is buckled securely around the trail leg.

(c) The elevating arc is clamped at zero.

(d) The cradle is aligned and clamped over the trail.

(e) The traversing dial is clamped.

(f) The gun latch lever functions properly and is down.

(g) The gun pintle housing is clear and clean.

(h) The elevating pin is fully inserted in its carrying recess.

(i) The elevating screw threads are exposed  $\frac{1}{2}$  inch.

(j) The gear housing is centered on the traversing screw.

(k) The elevating and traversing micrometers are set at zero.

(2) *No. 2 examines gun.* He pulls back the latch, raises the sight leaf and the cover, pulls the bolt to its rearmost position, engages the extractor cam plunger in rear of the extractor feed cam and examines the gun to see that—

(a) The muzzle of the barrel is packed and that the muzzle gland is screwed as tight as can be done with the fingers.

(b) The barrel is clear and clean.

(c) The water jacket is full of water.

(d) The water plugs are tight.

(e) The steam-condensing device is securely fastened and the hose is serviceable.

(f) The gun pintle is clean.

(g) The head space adjustment is correct (if necessary, makes correct adjustment) and the barrel locking spring functions correctly and is seated in a notch in the barrel.

(h) The moving parts are lightly oiled and function without excessive friction.

(i) The stud of the belt feed lever is to the left.

(j) The cover is latched (lowers it with the right hand).

(k) The tips of the adjusting plate blades are set at 700 yards and the sight leaf is lowered.

(l) The windage gauge is set at zero deflection.

(m) The trigger is pulled.

(n) The gun and gun cover are in their prescribed position.

(3) *No. 3 (and each ammunition bearer) inspects his ammunition and water chest(s) and sees that—*

(a) The cartridges are correctly aligned in the belt.

(b) For gun drill, there are no live rounds in the belt or in the ammunition chest.

(c) The ammunition belt is clean and dry.

(d) The ammunition belt is packed correctly in its box, with the brass tag down and to the front.

(e) The ammunition box is latched.

(f) The water chest is full of water.

(g) The lid is screwed on tightly.

(h) The outlet cap is tight.

b. Upon completion of examination of equipment, each man assumes his original position, and reports. No. 3 reports, "Ammunition correct"

or any deficiencies which cannot be corrected; No. 2 then reports, "Gun and ammunition correct" or the deficiencies; and No. 1 then reports, "All correct" or the deficiencies.

#### 48. Gunner's Position

a. **NORMAL POSITION** (fig. 46). In the normal position, the gunner (No. 1) sits behind the trail leg shoe with his feet under the trail leg. The knees are raised and turned outward. The elbows are placed inside the knees so that the flat parts on the back of the upper arms, just above the elbows, rest on the inside fleshy part of the knees. The left hand is placed so that the tip of the thumb is centered and well up on the grip, tip of the forefinger on the trigger, and other fingers folded back and resting lightly against the fleshy part of the palm without touching the forefinger or the grip. The left wrist is straight and flexible and vibrates with the movement of the gun when it is fired. The gun is fired by a pinching action with equal pressure of the left thumb and forefinger and is done without disturbing the lay of the gun. The right hand is held near, but not touching the traversing handwheel. The gunner holds his head erect, observing the target.

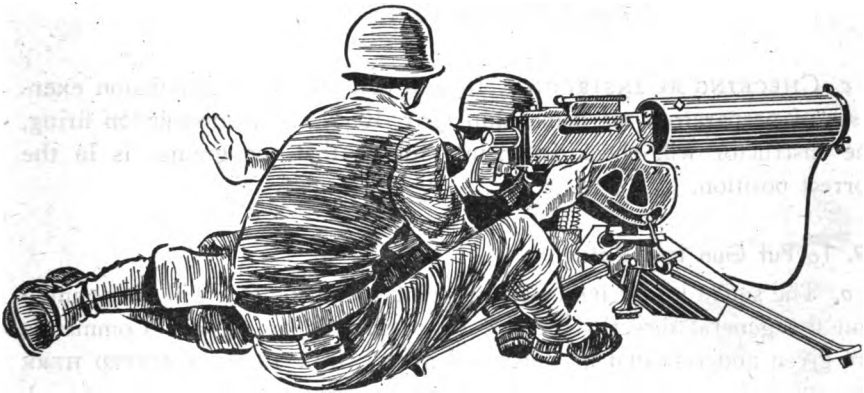
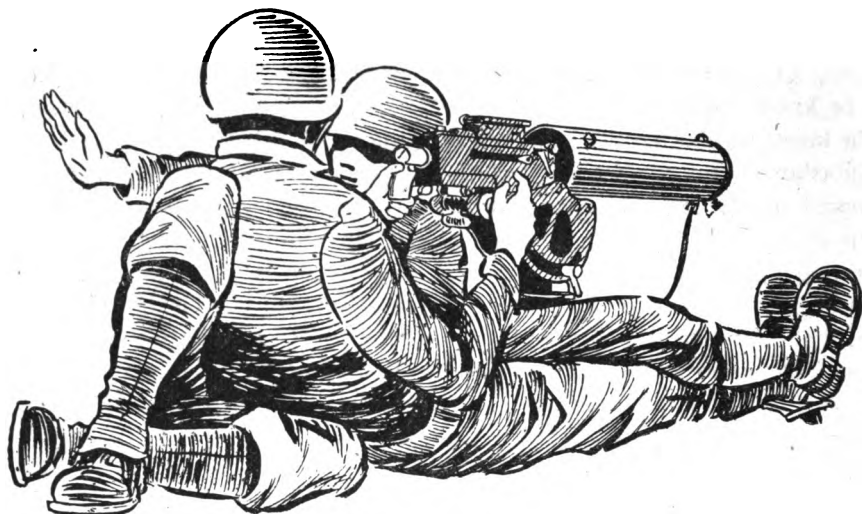


Figure 46. Gunner's normal position.

b. **Low POSITION** (fig. 47). When the gun is mounted in the low position, No. 2 lies on his left side with his legs in rear of the trail leg shoe and the upper part of his body on the left of the gun. He bends the left knee and places the left leg in position to support the back of No. 1; he bends and raises the right knee and places the right foot in a position so as to make a prop to support the upper portion of the back of No. 1, who is sitting in a semireclining position on the right side of the gun. In this position No. 1 has his right foot over the right tripod



leg, his left leg crossed over his right leg, his head in rear of the gun, and his eyes focused on the target. The position of the hands is the same as for the normal position.



*Figure 47. Gunner's low position.*

**c. CHECKING BY INSTRUCTOR.** In gun drill, in the manipulation exercises of preparatory marksmanship (par. 105), and in instruction firing, the instructor will check frequently to see that the gunner is in the correct position.

#### **49. To Put Gun Into Action**

**a.** The squad leader indicates the point where the gun will be mounted and the general direction of fire by commands or signals. Commands are given and repeated in steps, and are: 1. GUN TO BE MOUNTED HERE (THERE), 2. DIRECTION OF FIRE TO YOUR FRONT (LEFT) (RIGHT), 3. ACTION. (The gunner repeats all commands as follows: 1. GUN TO BE MOUNTED THERE (HERE), 2. DIRECTION OF FIRE TO MY FRONT (LEFT) (RIGHT), 3. ACTION.

**b.** At this command, the gun is mounted as shown in figures 48 to 59, inclusive.

#### **50. To Take Gun Out of Action**

**a.** The gun being in action, to take it out of action, the squad leader commands or signals: OUT OF ACTION.



*Figure 48.* No. 1 grasps the trail leg with his right hand at a point just in front of the nameplate.



*Figure 49.* No. 1 grasps the gun pintle housing with his left hand, lifts the tripod and carries it at a run to the designated point. No. 2 grasps the buffer tube with his right hand, and places his left hand on and around the water jacket.



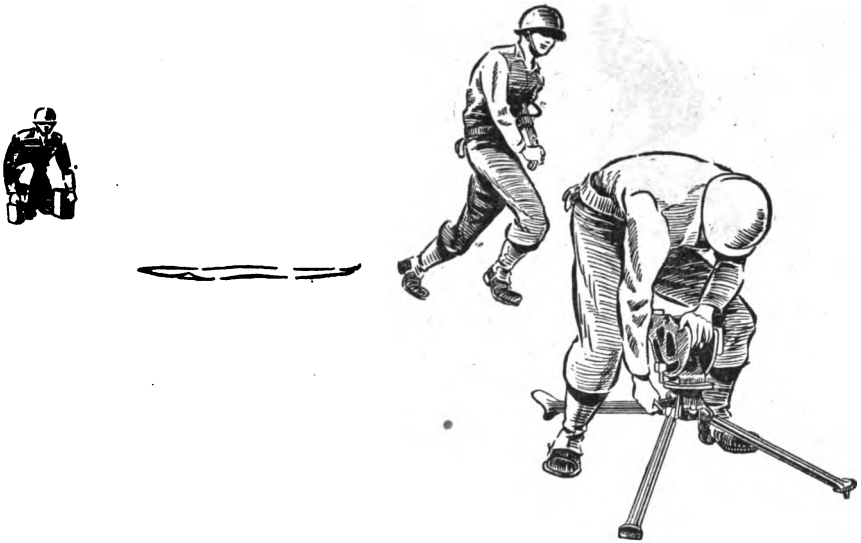
*Figure 50.* No. 1 places the tripod on the ground with the legs to the rear, straddles the legs, and unclamps the front legs simultaneously with both hands. No. 2 prepares to rise.



*Figure 51.* No. 1 regrasps the trail leg with his right hand and the gun pintle housing with his left hand, and swings the tripod up and to the front, throwing the front legs forward. No. 2 raises the gun under his left arm, muzzle to the rear and springs to his feet.



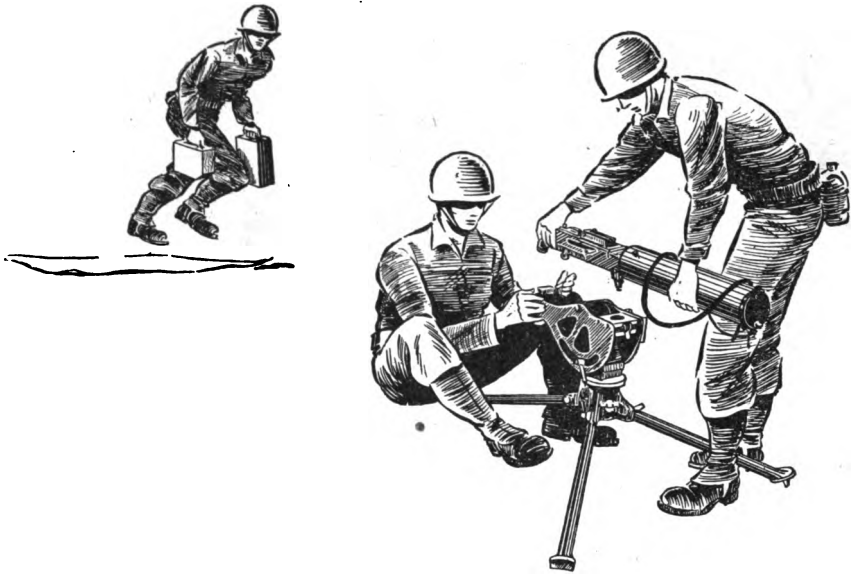
*Figure 52.* No. 1 removes his right hand from the trail leg. Still grasping the gun pintle housing with his left hand, he places his left forearm over his left thigh to steady the tripod, and glances up to see that the trail leg is aligned in the direction of fire. No. 2 starts forward.



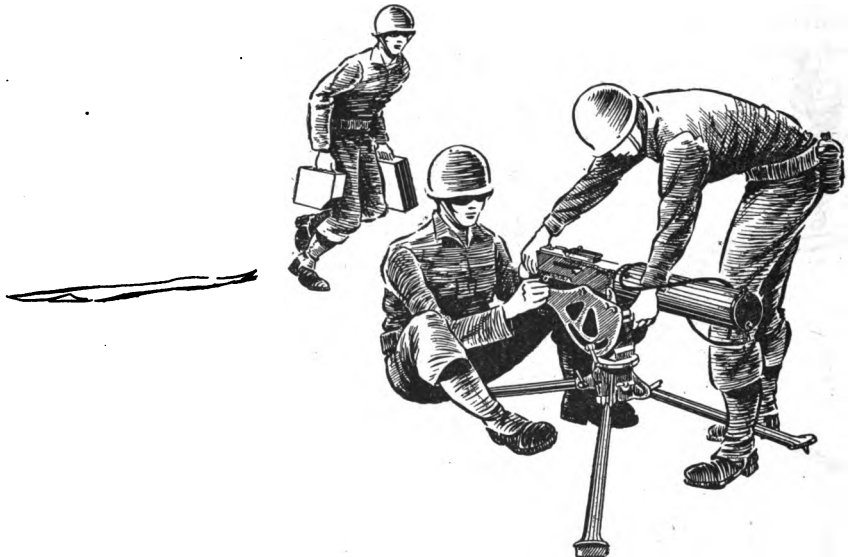
*Figure 53.* No. 1 adjusts the tripod to the ground so that the traversing dial is level, and with his right hand tightly clamps both front legs of the tripod, the right leg being clamped first. No. 3 prepares to rise.



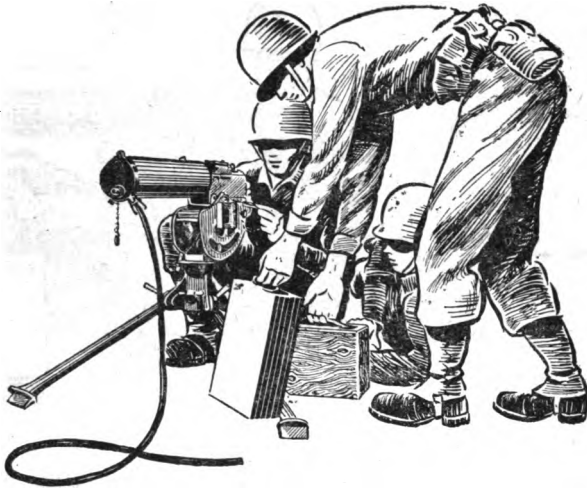
*Figure 54.* No. 1 stamps the trail leg shoe into the ground with his right foot. No. 2 runs to a position to the left of, and facing, the tripod. No. 3 springs to his feet and starts forward.



**Figure 55.** No. 1 sits down behind the tripod, withdraws the elevating pin and holds it in his left hand. No. 2 places his left foot between the front legs of the tripod and places the gun in position with the gun pintle in its housing.



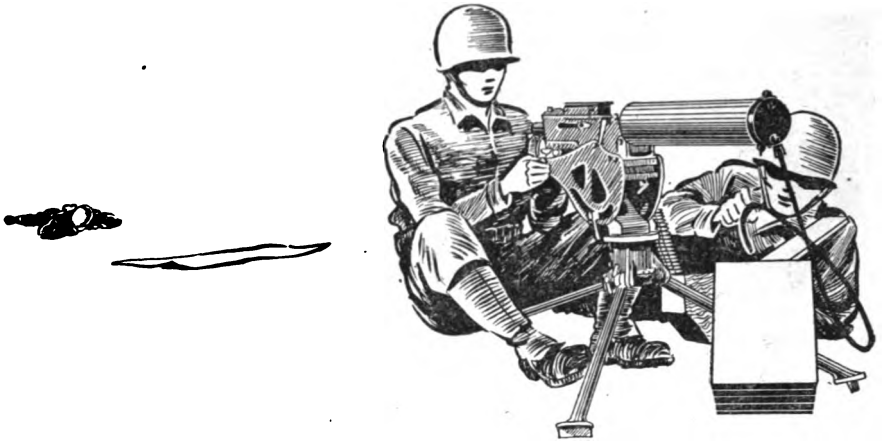
**Figure 56.** No. 2, with his left arm remaining over the water jacket, lifts the gun pintle latch lever, turning it down as soon as the pintle is fully seated.



**Figure 57.** No. 1 grasps the grip with his right hand, aligns the hole in the elevating screw head with the holes in the mounting bracket, and inserts the elevating pin with his left hand. No. 2 removes his right hand from the buffer tube, throws the free end of the steam condensing device clear of the gun with his left hand, and takes a position on his left side, to the left of, and facing, the gun, feet to the rear, and head below and in rear of the feedway. No. 3 arrives at the gun position, places the ammunition box, latch toward the gun, in line with the feedway, ready for loading, and places the water chest, lid up, in front of and leaning against the left leg of the tripod.

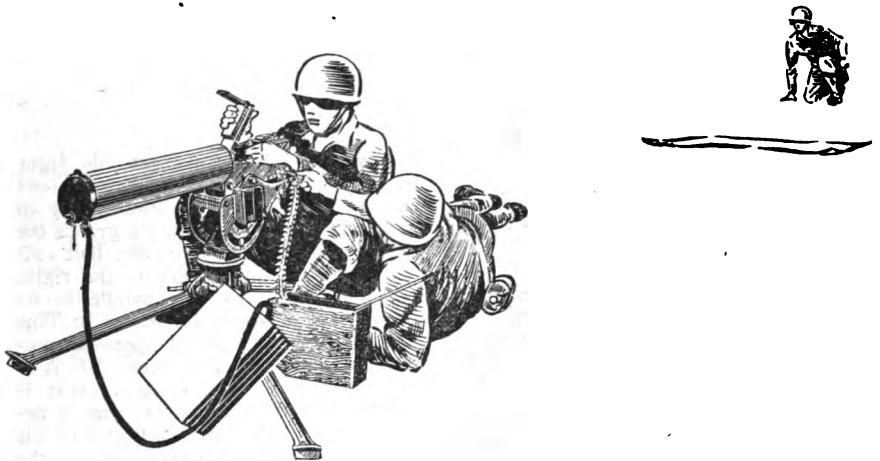


**Figure 58.** No. 1 advances his right hand to point opposite the belt exit and holds it in position ready to grasp the tag of the belt. He grasps the tag as it is pushed from the belt exit and gives it a quick jerk to the right. He then pulls the bolt handle to its rearmost position and releases it. This half loads the gun. No. 2 opens the ammunition chest (if antiaircraft fire is to be executed the ammunition chest is mounted on time bracket), grasps between the thumb and forefinger of his right hand a fold of the belt at the point where the tag joins the fabric, and pushes the tag through the feed opening as far as possible. He is responsible that the belt is straight and will feed properly and that the cover of the gun is latched. To do this he taps the cover at rear of windage screw housing before No. 1 pulls the bolt to the rear. No. 3 turns to the left about and returns to his original position.

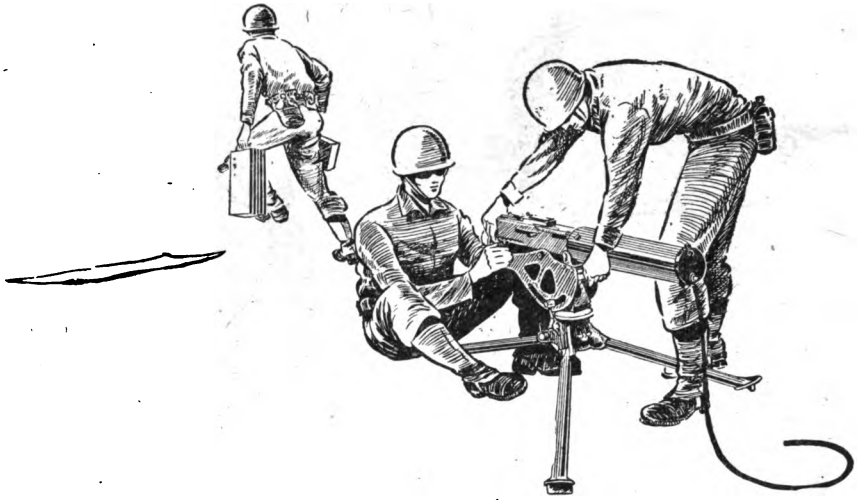


*Figure 59.* No. 1 assumes the gunner's position and calls, "Up." No. 2 signals: READY, removes the lid of the water chest and inserts the free end of the steam-condensing device into the water chest. (When higher numbers of the squad are present, they pass their ammunition boxes forward to No. 4 who aligns them at the position of No. 3 with the latches to the front.)

b. At the command the gun is taken out of action as shown in figures 60 to 67, inclusive.



*Figure 60.* No. 1 pulls back the latch with his left hand; with his right hand he raises the sight leaf and then raises the cover to the half open position. No. 2 lifts the belt and removes it from the feedway, replaces the belt in the ammunition box and latches the box cover. No. 1 then knocks down the extractor with his left hand, lowers the cover with his right hand, and lowers the sight leaf with his left hand. With his right hand he pulls the bolt handle once to its rearmost position and releases it, and presses the trigger with his left hand. No. 3 runs to the gun position.

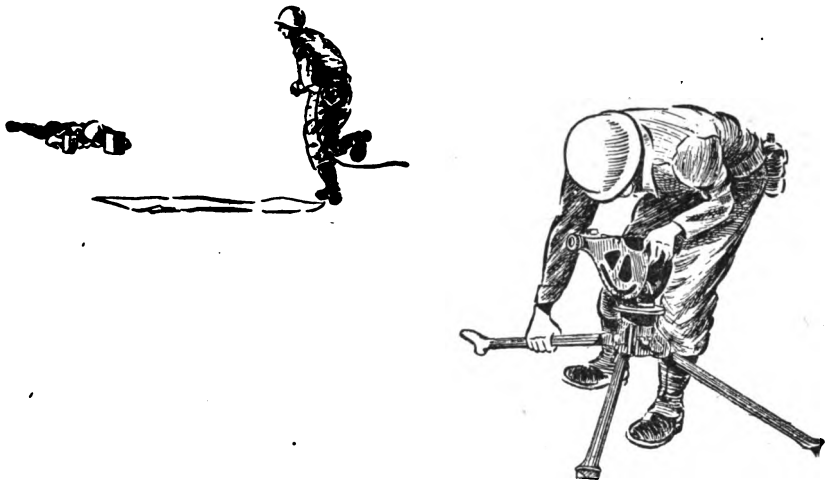


**Figure 61.** No. 1 removes the elevating pin with his left hand. No. 2 springs to his feet, places his right hand on the buffer tube, places his left foot between the front legs, passes his left hand over and under the water jacket, raises the gun pintle latch lever. No. 3 removes the steam-condensing device from the water chest, places the fingers of his left hand inside the opening in the top of the water chest and lifts the water chest from the ground, picks up the ammunition box with his right hand, turns to the left about, and runs to his original position.

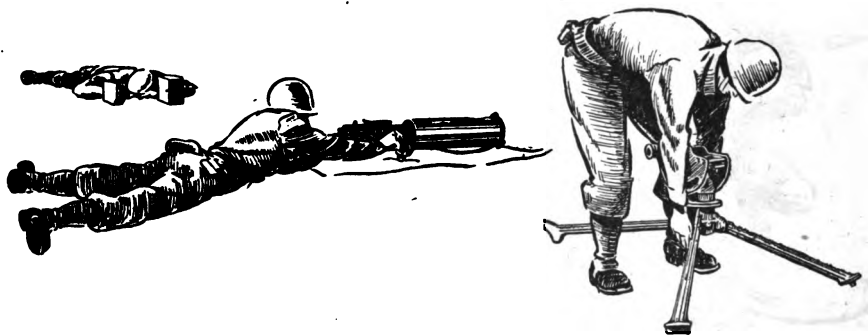


**Figure 62.** No. 1 places the elevating pin in its carrying recess. No. 2 lifts the gun from the tripod, carrying it under his left arm, muzzle to the rear, turns to the left about, and runs to his original position. No. 3 takes the prone position, replaces the lid of the water chest, keeping the chest upright, and sees that ammunition belt is properly repacked and the cover of the ammunition box latched. (When higher numbers of the squad are present, No. 4 secures the extra ammunition boxes from the position of No. 3 and passes them back.)

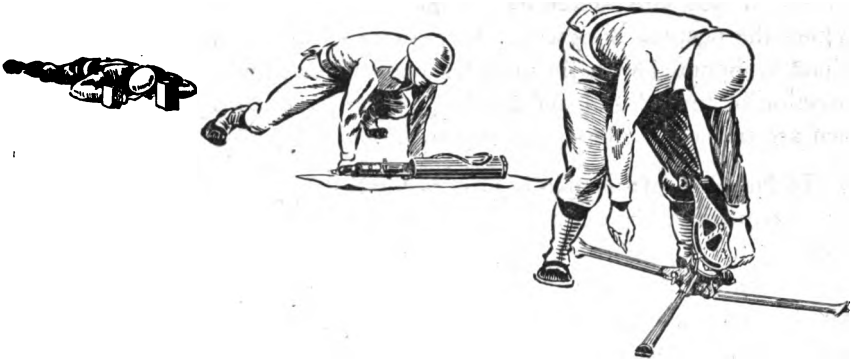




*Figure 63.* No. 1 turns down the gun pintle latch lever with his left hand and grasps the gun pintle housing. He grasps the trail leg with his right hand, lifts the tripod from the ground, turns to the left about, and runs to his original position.



*Figure 64.* No. 1 places the tripod on the ground with the trail leg to the rear, straddles the trail leg, and unclamps both front legs simultaneously, using both hands, allowing the tripod to collapse. No. 2 places the gun on the canvas gun cover, takes the prone position, and inspects the gun to see that (1) it is unloaded (by pulling the bolt handle to the rear and releasing it at least twice), (2) the rear sight is set at 700 yards, (3) the windage gauge is set at zero deflection, (4) the sight leaf is lowered, and (5) the trigger is pulled.



*Figure 65.* No. 1 regrasps the gun pintle housing with his left hand. No. 2 replaces the gun on the gun cover with the muzzle to the left and the windage knob up.



*Figure 66.* No. 1 lifts the tripod upward and rearward, pivoting the tripod on its trail leg shoe until the trail is vertical. (The front legs, of their own weight, fall back against the trail leg.) He clamps both front legs with his right hand. No. 2 returns to the prone position.



*Figure 67.* No. 1 lowers the tripod forward to the ground, takes the prone position on the left of the tripod, and calls, "Up."

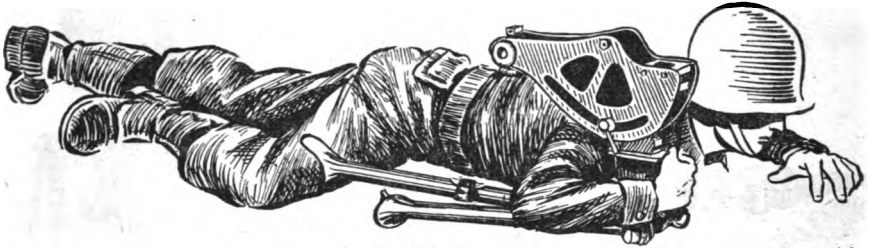
### 51. To Put Gun Into Action on a Slope

Where the position designated for the gun is on a pronounced slope, the tripod is mounted with the trail leg pointing downhill, regardless of the direction of fire. Nos. 1 and 2 take positions adapted to the ground. The men are trained to mount the tripod on any kind of ground.

### 52. To Put Gun Into Action in Low Position

a. Frequently, exposed firing positions require that the gun be mounted close to the ground. Before leaving the last available cover, the squad leader cautions No. 1, "Prepare for the low position." At this warning, No. 1 adjusts the trail leg so that the tripod can be mounted with the cradle pintle socket about 1 inch above the ground, with the shoes of the three legs, not their tubular portions, resting on the ground. Having completed this adjustment, he folds back the front legs and clamps them.

b. At the squad leader's command: 1. GUN TO BE MOUNTED HERE (THERE), 2. DIRECTION OF FIRE TO YOUR FRONT (LEFT OR RIGHT), 3. ACTION. The gun is mounted as shown in figures 68 to 72, inclusive.



*Figure 68.* No. 1 grasps the tripod with his right arm under the cradle and his right hand on the dial seat, and crawls with the tripod to the point indicated.



*Figure 69.* No. 1 uses both hands to loosen the front leg jamming handles.



*Figure 70.* No. 1 rolls the tripod first to its right and swings the left leg to the front, then to the left and swings the right leg to the front.



*Figure 71.* No. 1 supports the pintle socket in the palm of his left hand, sees that the trail leg is in the direction of fire, levels the dial, and with his right hand clamps both front legs, the right leg being clamped first. No. 2 crawls forward, cradling the gun in the bend of his elbows.



**Figure 72.** No. 1 takes position on the right of the tripod, feet to the front, assists No. 2 in placing the gun on the tripod, half loads the gun, assumes the gunner's low position, and calls, "Up." No. 2 lies on his left side to the left of, and facing the tripod, head to the front. Assisted by No. 1 he places the gun on the tripod and performs his other duties as described in paragraph 49*b*. He doubles up his legs so that his right leg serves as a prop and his left leg supports the back of No. 1. No. 3 crawls forward with the ammunition and water chests, places them within reach of No. 2, and crawls back to his position.

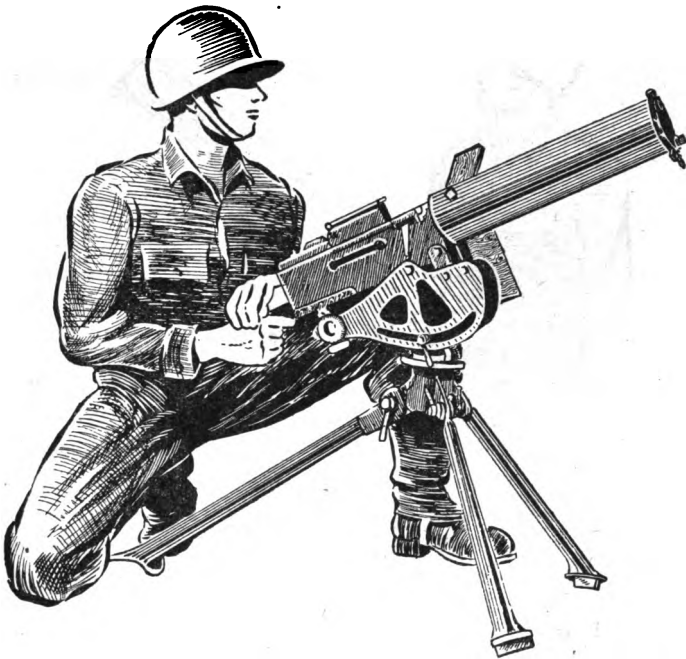
### **53. To Put Gun Into Action for Antiaircraft Fire**

When the gun is being carried by hand—

*a. WITH TRIPOD MOUNT.* Upon timely warning from the squad leader to prepare for the antiaircraft position, No. 1 adjusts the trail leg so that the tripod can be mounted in the highest position with dial level and front legs inclined slightly outward to maintain stability of the tripod. (See fig. 73.) At the command: 1. **ANTIAIRCRAFT**, 2. **ACTION**, the gun is mounted as prescribed in paragraph 49, except that—

(1) No. 3 brings forward the ammunition box only and hands it to No. 2 if he is ready to receive it, otherwise drops it at the position. Takes a position clear of the gun, and to the right rear. No. 2 attaches the ammunition box to the bracket, assists No. 1 in loading, removes the steam-condensing device, and takes a position clear of the gun, and to the left rear.

(2) No. 1 loosens the traversing clamp and the cradle clamping handle, and takes the gunner's position as follows: He kneels on his right knee with his right buttock resting on his right heel. His upper left leg is parallel to the trail leg with the lower part of his leg vertical to the ground. His right hand grasps the pistol grip, forefinger on the trigger. His right arm is held firmly against his body. His left hand is placed on top of the buffer tube with his left fingers gripping the top of the buffer tubes and his right hand. The left elbow is supported on top of his left knee. His head is erect with his eyes focused on the target.



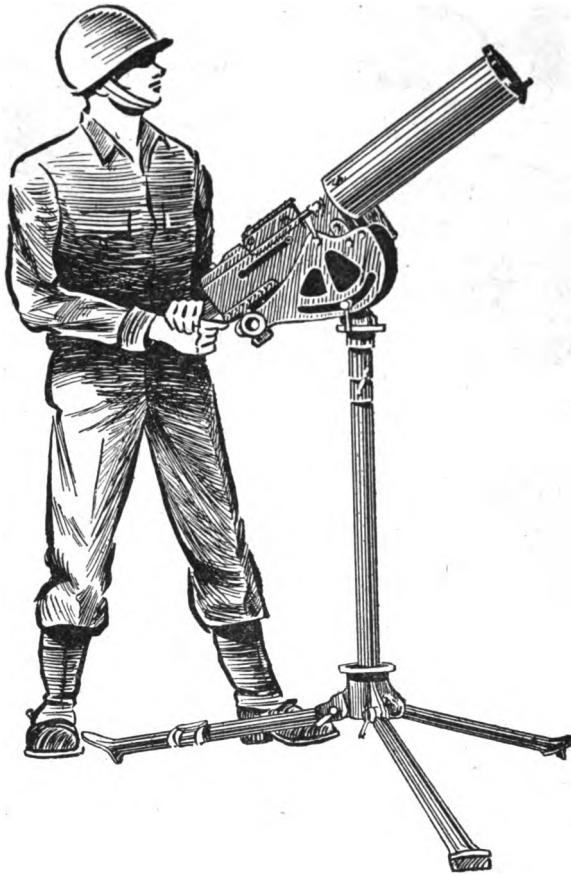
*Figure 73. Gunner's antiaircraft position with tripod mount.*

**b. WITH ELEVATOR MOUNT.** At the command: 1. WITH ELEVATOR, 2. ANTI-AIRCRAFT, 3. ACTION, the gun is put into action as prescribed in paragraph 49 except that it is not half loaded. No. 1 loosens the traversing clamp and removes the gun and cradle from the tripod. No. 2 inserts the elevator pintle in the cradle pintle socket with elevator clamp to the right, and tightens the traversing clamp. No. 1 inserts the cradle pintle in the elevator socket, loosens the cradle clamping handle, and takes the gunner's position (fig. 74) as follows: He stands erect with the right foot well to the rear, and left foot alongside the elevator pintle. Hands are placed as described in *a*(2) above. Forearms are held against the body. Small changes in direction are made by pivoting the hips; small changes in elevation by bending the knees; larger changes require shifting the entire position.

**c.** Variations of the positions shown are authorized. In combat, the presence of No. 2 at the gun is not necessary. He should take cover nearby.

#### **54. To Move Gun**

**a. GENERAL.** Being in action, the gun may be moved for short distances by the dragging method, by the two-man load method, or by the



*Figure 74. Gunner's antiaircraft position with elevator mount.*

three-man load method. Before movement is started, the squad leader commands: **UNLOAD**. The gun is unloaded and the belt placed properly in the box. Should the squad leader fail to give the command, No. 1 will unload upon receiving the order for the move.

*b. DRAGGING.* Where considerations of cover require personnel to move by crawling, the gun is dragged by Nos. 1 and 2 to its new position. The gun may be dragged in any direction at the squad leader's command: 1. **DRAG GUN**, 2. **FOLLOW ME (TO THAT BUSH)**. At this command, the gun is unloaded and the ammunition belt replaced in its box (if this has not been done already) and the chest is placed on the bracket by No. 2. When mounted, the gun may be dragged in either the normal or low position.

(1) To drag the gun to the front, No. 1 takes a prone position to

the right of and parallel to the gun, head to the front, grasps the right tripod leg with his left hand, and crawls forward until his left arm is fully extended close to the side of his body. No. 2 assumes a similar position to the left of the gun, passes the free end of the steam-condensing device over his shoulders, replaces the lid on the water chest, grasps the water chest and the free end of the condensing device in his left hand, and the left tripod leg in his right hand. When ready, No. 1 calls, "Up." Nos. 1 and 2 lift the front tripod legs, drag the gun forward a foot or more (the trail leg resting on the ground). They crawl forward until their arms on the side next to the tripod are extended, and again pull the gun forward. They alternately pull the gun and crawl in the trace of the squad leader or to the designated position.

(2) To drag the gun to the rear, No. 1 takes a prone position to the right and to the rear of the trail leg, body parallel to the trail leg, head to the front, left arm extended, and left hand grasping the trail leg. Keeping in a prone position, No. 2 removes the steam-condensing device from the water chest, replaces the lid, and moves to a position similar to No. 1 to the left of the trail leg, right hand grasping the trail leg and left hand holding the water chest. At the command UP, given by No. 1, they lift the trail leg and pull the gun to them. They alternately crawl back until their arms are extended, and pull the gun to them. The steam-condensing device is allowed to drag on the ground.

(3) To drag the gun to the right or left, the movement is accomplished as described in (1) above, except that No. 1 grasps the trail leg and No. 2 the front leg on the side in which the movement is to be made.

(4) If necessary, No. 3. and the higher numbers move to their new positions by crawling.

c. TWO-MAN LOAD. The squad leader commands: 1. TWO-MAN LOAD, 2. FOLLOW ME (TO SUCH-AND-SUCH POSITION).

(1) At this command, the gun is unloaded and No. 1, keeping well down, if necessary, moves to the right of and faces the gun. He grasps both the ammunition box (passed to him by No. 2) and the right leg of the tripod with his right hand. With his left hand he grasps the trail leg.

(2) No. 2, after passing the ammunition box to No. 1, replaces the lid on the water chest and takes a position to the left of and facing the gun. He places the steam-condensing device over his shoulders and grasps the free end and the water chest in his right hand and the left leg in his left hand.

(3) After the loads have been secured, No. 1 calls, "Up." Both men spring up, and moving rapidly, with the trail leg leading, carry the equipment in the trace of the squad leader or to the objective designated.



(4) Remaining members of the squad follow the gun crew in squad column.

d. **THREE-MAN LOAD.** For a three-man load, the command given by the squad leader is: 1. **THREE-MAN LOAD**, 2. **FOLLOW ME (TO SUCH-AND-SUCH POSITION)**.

(1) At this command, the gun is unloaded, the belt replaced in the ammunition box, and the lid replaced on the water chest.

(2) No. 3, keeping well down, if necessary, moves to a position to the right of, and facing the gun. He grasps the right leg of the tripod with his right hand and the ammunition box (passed to him by No. 2) with his left hand.

(3) No. 2, having passed the ammunition box to No. 3 and replaced the lid on the water chest, moves to a position to the left of and facing the gun. He passes the free end of the steam-condensing device over his shoulders, grasps the free end and the water chest in his right hand, and the left leg of the tripod in his left hand.

(4) No. 1 takes a position to the right of and facing the trail leg, and grasps the trail leg in his right hand.

(5) When all are ready, No. 1 calls, "Up" and the movement is carried out as prescribed for the two-man load.

(6) Remaining members of the squad follow the crew in squad column.

e. **TO PICK UP TRIPOD.** (1) *Method 1.* The tripod being mounted, the gunner places himself in front of and facing the tripod, grasps the right leg with both hands, the left hand just above the shoe, the right hand at the upper part of the right leg. He lifts the tripod straight up above the height of the shoulders, at the same time turns his body counter-clockwise, steps under the tripod, and then lowers it so that the legs rest on his shoulders with the trail leg extending down his back. A left-handed man may grasp the left leg instead of the right leg, and turn clockwise.

(2) *Method 2.* The tripod being mounted, the gunner places himself to its left with his right knee on the ground, the lower part of his leg parallel with the trail leg. Grasping the tripod left leg with his left hand, and the trail leg with his right hand, he raises the tripod, pivoting it on its right leg shoe, and then pulls it close to his body. He moves his right hand beneath the cradle pintle socket and grasps the tripod right leg, the trail leg resting against his upper right arm. He lifts the tripod and places the trail leg on his right shoulder; raises the tripod left leg over his head and places it on his left shoulder; at the same time, the tripod right leg slides to its position on the right shoulder and the trail leg to its position extending down his back. He then stands.

f. To LOWER TRIPOD. To lower the tripod to the ground from its position on the shoulders, the movements are made in the reverse order to that described in (1) and (2) above.

### Section III. GUN DRILL WITH M1919A4 MACHINE GUN

#### 55. To Secure Equipment and Form for Gun Drill

a. The command is: SECURE EQUIPMENT. Men secure equipment as follows:

Personnel	Equipment*
Squad leader .....	Cleaning rod. When there is no ammunition bearer, he secures the spare parts chest and spare barrel.
No. 1 .....	Tripod. He may also carry a box of ammunition.
No. 2 .....	Gun. Asbestos mittens. Canvas gun cover. (If there is no ammunition bearer, he also carries one box of ammunition).
No. 3 .....	1 box of ammunition. 1 spare parts chest. 1 spare barrel. 2 ammunition bags.
All higher numbers..	2 boxes of ammunition. 2 ammunition bags.

\*Dependent upon current T/O & E.

b. Having secured equipment, the squad forms in column with five paces between men, No. 1 five paces from and facing the squad leader. Each man grounds his load and takes the prone position as follows:

- (1) No. 1 with the tripod to his left, legs to the rear.
- (2) No. 2 with the gun to his front, muzzle to the right, windage knob up, resting on the canvas gun cover.
- (3) No. 3 with ammunition box, spare parts chest, and spare barrel to his front, chests 1 foot apart, ammunition box on the right, latch to the front, spare parts chest on left, latch to the right, spare barrel to the right of the spare parts chest.
- (4) Other members, if present, with ammunition boxes in front, 1 foot apart, latches to the front.

#### 56. To Examine Equipment

a. As with the M1917A1 gun, a thorough examination of the equipment is made at the beginning and at the end of each drill period. Upon a change of numbers, such examination of the equipment is made without report, as will determine that it is in proper condition for the execution of the drill. The same procedure is followed in drill and in the field,

except that in drill live ammunition is assumed. The equipment being grounded, the squad leader commands: **EXAMINE EQUIPMENT BEFORE FIRING.** At this command, each man, keeping well down, examines his equipment as indicated below :

(1) No. 1 examines the tripod and sees that—

(a) The front leg and trail legs are closely folded.

(b) The traversing bar sleeve latch and pintle latch function properly.

(c) The pintle socket is clear and clean.

(2) No. 2 examines the gun. He pulls back the latch, raises the front sight and the cover, pulls the bolt to its rearmost position, engages the extractor cam plunger in rear of the extractor feed cam, and sees that—

(a) The barrel is clear and clean, and that the front plug is tight.

(b) The front sight body is tight.

(c) The gun pintle is clean.

(d) The head space adjustment is correct (if necessary, makes correct adjustment) and the barrel locking spring functions correctly and is seated in a notch in the barrel.

(e) The moving parts are lightly oiled and function without excessive friction.

(f) The stud of the belt feed lever is to the left.

(g) The cover is closed.

(h) The front sight is lowered.

(i) The rear sight is set at 700 yards (two clicks below 800) and the sight leaf is lowered.

(j) The windage gauge is set at zero deflection.

(k) The trigger is pulled.

(l) The gun is placed in its original position.

(3) No. 3 (and each ammunition bearer) inspects his ammunition box(es), spare barrel, and spare parts chest, and sees that—

(a) The cartridges are correctly aligned in the belt.

(b) For gun drill, there are no live rounds in the belt or in the ammunition box.

(c) The ammunition belt is clean and dry.

(d) The ammunition belt is packed correctly in its box, with the brass tag down, and to the front.

(e) The ammunition box is latched.

(f) The bore of the spare barrel is clear and clean.

(g) The front and rear bearings are free from dirt.

- (h) The barrel and barrel extension are properly assembled.
- (i) The contents of the spare parts chest are as prescribed and properly packed.
- (j) The spare parts chest is latched.

b. Upon completion of examination of equipment, each man assumes his original position and reports. No. 3 reports, "Ammunition correct" or any deficiencies which cannot be remedied; No. 2 then reports, "Gun and ammunition correct" or the deficiencies; No. 1 then reports, "All correct" or the deficiencies.

## 57. Gunner's Position

a. **NORMAL POSITION** (fig. 75). In the normal position, the gunner (No. 1) is in a prone position such that a line in prolongation of the axis of the bore will pass through his right shoulder and right buttock. Legs are apart and heels down. The upper part of his body is supported by the elbows. The right elbow is drawn in close to the body, the left elbow inside of, but not touching, the left trail shoe. The right hand grasps the grip firmly with the forefinger on the trigger. The left hand grasps the elevating handwheel. Because of play in the elevating mechanism and the light mount, pressure is exerted forward and down with the left hand, and to the left or right with the right hand. There should be the same pressure in sighting as in firing. The right cheek is against the buffer tube. Eyes are focused on the target.



Figure 75. Gunner's normal position.

b. **CLOSE COMBAT POSITION** (fig. 76). (1) This position is used in emergencies for quick surprise fire, at close ranges, usually under 25 yards. Its primary use is principally in advancing in woods, fog, smoke, in street fighting, and in mopping up. It should not be used when well aimed fire is possible.

(2) The gunner faces the target squarely, left foot slightly forward to

offset the slight recoil. The left hand grasps the barrel jacket, thumb on top (an asbestos mitten should be used if available). The left arm is straight and rigid. The right hand holds the grip against the body in front of the right hip, right forefinger on the trigger. The ammunition belt is slung over the left arm; over the left shoulder; cut into lengths of 35 to 50 rounds, or carried by the assistant gunner.



*Figure 76. Close combat firing position.*

(3) A sling, improvised from an empty ammunition belt, may be used to carry the gun in the ready position. The belt is doubled, slipped under the grip, passed around the back of the neck, adjusted to the proper length, and tied around the barrel jacket. The gunner, when using the sling, can readily fire while walking by holding the grip at the side of his right hip.

c. INSTRUCTION. In gun drill, in the manipulation exercises of preparatory marksmanship (par. 105), and in instruction firing, the instructor will check frequently to see that the gunner is in the correct position.

### 58. To Put Gun Into Action

a. The squad leader indicates the point where the gun will be mounted and the general direction of fire by commands or signals. Commands are given and repeated in steps, and are: 1. GUN TO BE MOUNTED HERE (THERE), 2. DIRECTION OF FIRE TO YOUR FRONT (LEFT) (RIGHT), 3. ACTION. (The gunner repeats all commands, as follows: 1. GUN TO BE MOUNTED THERE (HERE), 2. DIRECTION OF FIRE TO MY FRONT (LEFT) (RIGHT), 3. ACTION.)

b. At this command, Nos. 1 and 2 proceed as follows:

*No. 1 (Tripod)*

*No. 2 (Gun)*

*In the prone position.*

Grasps the right trail near the tripod head with the right hand.

*Springs up.*

Carries the tripod at a run, left trail leg uppermost, to the designated point.

Rests the shoes of the trail legs on the ground, steadying the tripod in a vertical position with the front leg to the front.

Lifts the front leg forward and upward into position with his left hand.

Grasps the left trail leg near the shoe with his left hand and the right trail leg near the shoe with his right hand.

Lifts the tripod from the ground and, with a quick jerk, separates the trail legs until the sleeve latch engages the traversing bar sleeve.

Drops the tripod to the ground, with the front leg in the direction of fire.

*In the prone position.*

Grasps the buffer tube with the right hand and places the left hand on and around the barrel jacket.

*Springs to his feet.*

Places the gun under his left arm, muzzle to the rear.

Runs to a position to the left of and facing the tripod.

Places his left foot in the space between the left trail leg and the front leg.

*No. 1 (Tripod)*

*Lies down in rear of the traversing bar.*

Grasps the grip with his left hand and assists No. 2 in placing the gun in position.

Disengages the elevating mechanism from the slot in the grip by rotating it a half turn to the right. Assembles it to the traversing bar, and clamps it at zero deflection.

Advances his right hand to a point opposite the belt feed exit and holds it in position ready to grasp the tag at the end of the belt.

Grasps the tag as it is pushed from the belt exit and gives it a quick jerk to the right.

Pulls the bolt handle to its rear-most position and *releases* it.

*Assumes the gunner's position.*

(See fig. 75.)

Calls, "Up."

c. At the moment that No. 2 lies down, No. 3 arrives at the gun position with his load. No. 3—

(1) Places the ammunition box, latch toward the gun, in line with the feedway, ready for loading.

(2) Places the spare barrel and the spare parts chest to the left of the ammunition box, latch of the spare parts chest to the rear.

*No. 2 (Gun)*

Assisted by No. 1, places the gun in position.

Inserts the gun pintle in the gun pintle socket, raises the gun pintle latch lever with his right hand and lowers it when the pintle is fully seated.

*Lies down* to the left of the gun, or his left side, with his head in rear of the feedway, and his feet to the rear. (See fig. 75.)

Opens the ammunition box placed for him by No. 3.

Grasps between the thumb and forefinger of his right hand a fold of the belt at the point where the tag joins the fabric and pushes the tag through the feed opening as far as possible. He is responsible that the belt is straight and will feed properly, and that the cover of the gun is latched, testing for latching by tapping.

As soon as No. 1 has called "Up," signals: READY.

(3) Turns to the left about and returns to his original position.

(4) No. 4, if present, aligns the ammunition boxes at the position of No. 3.

### 59. To Take Gun Out of Action

a. The gun being in action, to take it out of action, the squad leader commands or signals: **OUT OF ACTION.**

b. At the command, Nos. 1 and 2 proceed as follows:

#### *No. 1 (Tripod)*

*In the gunner's position.*

Pulls back the latch with his right hand.

Raises the cover to the half-open position with his left hand.

Brushes his left hand across the top of the bolt to make sure the extractor is down.

Lowers the cover with his left hand.

Pulls the bolt handle to its rear-most position with his right hand and *releases it.*

Presses the trigger with his right forefinger.

Grasps the grip with his left hand and, with his right hand, disengages the elevating mechanism from the traversing bar, turns the lower half through 180°, and secures it in the recess in the grip.

Places both hands on the trail legs near the shoes and, keeping his head well to the right, presses downward until No. 2 has removed the gun.

Grasps the sleeve latch with his right hand and releases it.

#### *No. 2 (Gun)*

*Lying to the left of and facing the gun, legs to the rear.*

As soon as No. 1 raises the cover, lifts the belt and removes it from the feedway.

Packs the belt in the ammunition box and latches the cover.

*Springs to his feet.*

Places his left foot on the front leg shoe.

Grasps the buffer tube with his right hand, reaches over and around the barrel jacket with his left hand, raising the gun pintle latch lever, and removes the gun from the tripod.



*No. 1 (Tripod)*

*Springs to his feet.*

Grasps the tripod head with his right hand, knocking down the gun pintle latch lever.

Lifts the front of the tripod to the vertical position.

Grasps the front leg of the tripod with the left hand and folds it to the front and down.

Tilts the tripod to the right and closes the trail legs with the left hand.

Grasps the right trail leg near the tripod head with the right hand and, with the left trail leg uppermost, turns to the left about, and runs to his original position.

Lays the tripod on the ground, trail legs to the rear.

*Returns to the prone position to the left of the tripod and calls "Up."*

c. At the command, OUT OF ACTION, No. 3 runs to the gun position where he—

(1) With his left hand, picks up the spare barrel and the spare parts chest.

(2) With his right hand, picks up the ammunition box (as soon as No. 2 has latched its cover).

(3) Turns to the left about and runs to his original position. Takes the prone position and sees that the ammunition belt is properly repacked and the cover of the box latched.

d. No. 4, if present, secures his ammunition boxes from the position of No. 3 and runs to his original position.

**60. To Put Gun Into Action on a Slope**

The machine gun tripod mount, M2, is not adjustable for more than one position. Therefore, when going into action on a slope, members of the gun crew must level the ground by cutting away the soil at the location of the shoes. The front leg is always pointed in the general direction of the target.

*No. 2 (Gun)*

Turns to the left about and runs to his original position.

Places the gun on its cover.

Inspects the gun to see that—

It is unloaded by pulling the bolt twice to the rear and releasing it.

The front sight post is down.

The rear sight is set at 700 yards.

The sight leaf is lowered.

The windage gauge is set at zero deflection.

The trigger is pulled.

Replaces the gun on the gun cover with the muzzle to the left and the windage knob up.

*Resumes the prone position.*

## 61. To Put Gun Into Action for Antiaircraft Fire

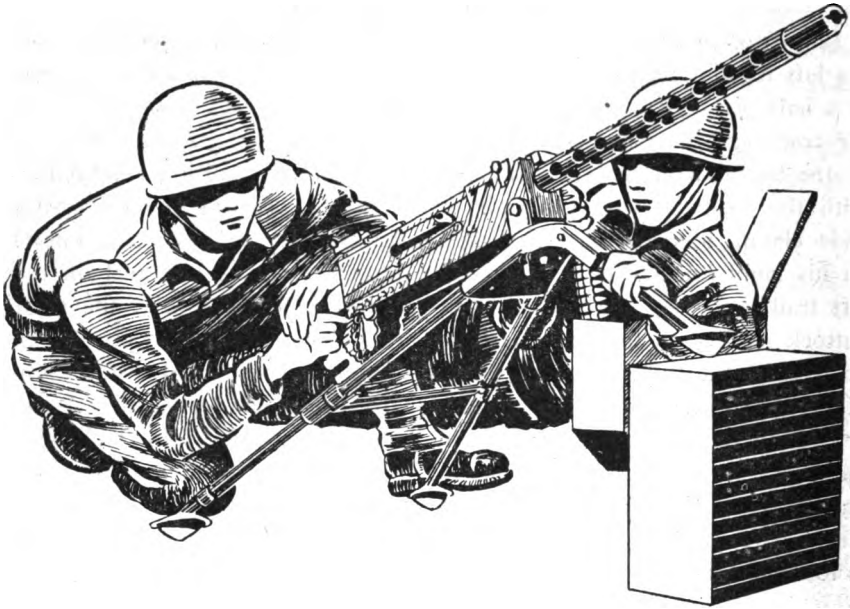
a. The M1919A4 machine gun, mounted on the M2 tripod, is not well suited for antiaircraft fire. However, if a decision is made to engage hostile aircraft with light machine guns, the command is: 1. ANTI-AIRCRAFT, 2. ACTION. The following methods may be used:

(1) *First method* (fig. 77). No. 2 assumes the sitting position with his left leg flat on the ground and his right knee flexed approximately to a half bend. No. 1 places the tripod head on No. 2's right knee with the trail leg shoes resting on the ground. No. 2 grasps the front leg of the tripod with his left hand and keeps the ammunition belt in line with the feedway with his right hand. No. 1 releases the traversing slide clamp, secures the elevating mechanism in the grip, and kneels on his right knee directly behind the gun, placing his left heel on the left trail leg shoe. The buttocks are dropped well down, with the right buttock resting on the right heel. The right hand grasps the pistol grip firmly with the right forefinger on the trigger; the left hand rests on top of the grip. The body is crouched well forward. The left arm rests on or around the left knee for support. From this position, No. 1 changes the direction of aim by twisting his body while pivoting on his right knee and left foot, in order to follow the direction of the moving air target. If necessary, he may move either his left foot or right knee so as to follow the target.



Figure 77. Antiaircraft position, first method.

(2) *Second method* (fig. 78). Place the front leg of the tripod on the spare parts chest. No. 2 grasps the front leg with his left hand and holds it in place while No. 1 proceeds as described in (1) above.



*Figure 78. Antiaircraft position, second method.*

(3) *Third method* (fig. 79). If the barrel is not too hot, No. 1 loads the gun, releases the traversing bar clamp, and seats the elevating mechanism in its carrying recess. He then kneels on his right knee with his left leg bent so that the lower leg is approximately vertical, toe pointing in the general direction of the target. Having an asbestos mitten on his left hand, he grasps the barrel jacket with that hand, and the pistol grip with his right hand. He pivots the tripod on the trail leg shoes, raising the gun to the desired position to engage the target. No. 2 supports and guides the belt with his right hand. (See fig. 79.) To change direction to the rear, No. 1 tilts the tripod to the right on the right trail leg and turns the gun and tripod to the right about. The gun normally should be turned to the right in order to prevent the muzzle of the gun from turning toward No. 2 and to permit No. 2 to follow the gun. However, the gun may be turned to the left about providing No. 2 moves prior to No. 1.

b. Under varying conditions in battle, expedients such as resting the barrel jacket in the fork of a tree or a notch in a wall, may be useful.



*Figure 79. Antiaircraft position, third method.*

### **62. To Move Gun**

Before movement is started, the squad leader commands: UNLOAD. The gun is unloaded and the belt placed properly in the box. At the command: 1. TWO-MAN LOAD, 2. FOLLOW ME (TO SUCH-AND-SUCH POSITION), No. 1 seizes the right trail leg with his right hand and the left trail leg with his left hand. No. 2 seizes the front leg with his right hand and the ammunition box with his left hand. When both are ready, No. 1 calls, "Up." Both men spring up and carry the gun and ammunition box in the trace of the squad leader or to the objective designated. The remainder of the equipment is carried by Nos. 3 and 4 if they are present.

## Section IV. GUN DRILL WITH M1919A6 MACHINE GUN

### 63. To Secure Equipment and Form for Gun Drill

a. Gun drill with the M1919A6 gun (with tripod mount M2) is performed in the same manner as with the M1919A4 gun.

b. Gun drill is also performed with the gun on bipod mount. The command is: SECURE EQUIPMENT. Men secure equipment as follows:

Personnel	Equipment*
Squad leader .....	Cleaning rod. When there is no ammunition bearer, he also secures one box of ammunition.
No. 1 .....	Gun. Asbestos mittens. Canvas gun cover.
No. 2 .....	1 box of ammunition. 1 spare parts chest. 1 spare barrel. 2 ammunition bags.
No. 3 .....	2 ammunition boxes. 2 ammunition bags.
No. 4 .....	Same as No. 3.

\*Dependent upon current T/O & E.

c. Having secured equipment, the squad forms in column with five paces between men, No. 1 five paces from and facing the squad leader. Each man grounds his load and takes the prone position as follows:

(1) No. 1 with the gun to his front on the bipod rest legs, muzzle to the left, windage knob up, resting on the canvas gun cover.

(2) No. 2 with the ammunition box, spare parts chest, and spare barrel to his front, chests 1 foot apart, ammunition box on the right, latch to the front, spare parts chest to the left, latch to the right, and spare barrel to the right of the spare parts chest.

(3) No. 3, if present, with the ammunition boxes in front, 1 foot apart, latches to the front.

(4) No. 4, same as No. 3.

### 64. To Examine Equipment

a. As with the other types of machine guns, a thorough examination of the equipment is made at the beginning and at the end of each drill period. Upon a change of numbers, such examination of the equipment, without report, is made as will determine that it is in proper condition for the execution of the drill. The same procedure is followed in drill and in the field, except that in drill, live ammunition is assumed. The equipment being grounded, the squad leader commands: EXAMINE

**EQUIPMENT BEFORE FIRING.** At this command, each man, keeping well down, examines his equipment as indicated below :

(1) No. 1 examines the gun and sees that—

(a) The front sight and the cover are raised. Pulls the bolt to the rear and engages the extractor cam plunger behind the notch of the extractor feed cam.

(b) The bipod upper thumb screws are loosened and the leg tubes are clamped in the upright position. Loosens bipod lower thumb screws and sees that the extensions of the bipod legs work smoothly. Sees that the extensions are pushed into the bipod leg tubes (unless the gunner knows the distance they should extend to level the barrel when he is in the firing position on level ground) and that the bipod lower thumb screws are tight.

(c) The barrel is clear and clean.

(d) The booster cap is positioned properly and the retaining clip assembly is engaged in the slots of the front barrel bearing and the booster cap body.

(e) The bipod lock ring is positioned properly.

(f) The front sight body is tight.

(g) The head space is correct (if necessary makes correct adjustment) and the barrel locking spring functions correctly and is seated in a notch in the barrel.

(h) The moving parts are lightly oiled and function without excessive friction.

(i) The stud of the belt feed lever is to the left.

(j) The cover is latched.

(k) The front sight is lowered.

(l) The rear sight is set at 700 yards (two clicks below 800) and the sight leaf is lowered.

(m) The windage gauge is set at zero deflection.

(n) The trigger is pulled.

(o) The shoulder stock is properly positioned and the clamp wing nut is tight.

(2) No. 2 (and each ammunition bearer) inspects his ammunition box(es), spare barrel, and spare parts chest and sees that—

(a) The cartridges are correctly aligned in the belt.

(b) For gun drill, there are no live rounds in the belt or in the ammunition box.

(c) The ammunition belt is clean and dry.

(d) The ammunition belt is packed correctly in its box, with the brass tag down and to the front.

(e) The ammunition box is latched.

(f) The bore is clear and clean.

(g) The front and rear bearings are free from dirt.

(h) The contents of the spare parts chest are as prescribed and properly packed.

(i) The spare parts chest is latched.

b. Upon completion of the examination of equipment, each man assumes his original position, and reports as follows: No. 2 reports, "Ammunition correct" or the deficiencies. No. 1 then reports, "All correct" or the deficiencies.

### 65. Gunner's Position (fig. 80).

a. The gunner (No. 1) is in a prone position such that a line in prolongation of the axis of the bore will pass through the right shoulder and the center of the buttocks. This forms a pocket for the shoulder stock between the neck and the right shoulder and decreases lateral movement of the gun while firing. The inner sides of the feet are flat on the ground, toes pointing outward, and legs well separated. The upper part of the body rests on the elbows. The elbows are out to the sides to form a stable base of support for the rear of the gun. The left hand grasps the shoulder stock, palm down. The right hand grasps the pistol grip firmly, with the forefinger on the trigger. The eyes are focused on the target through the peep sight. The body is relaxed. The breath is held during aiming and firing. A little more air is drawn into the lungs than is used in an ordinary breath, a little is let out, and the rest held naturally and without restraint. Small lateral adjustments of the line of sight can be made by moving the shoulders. If the necessary lateral movement is sufficient to require movement of the elbows the entire body is shifted.

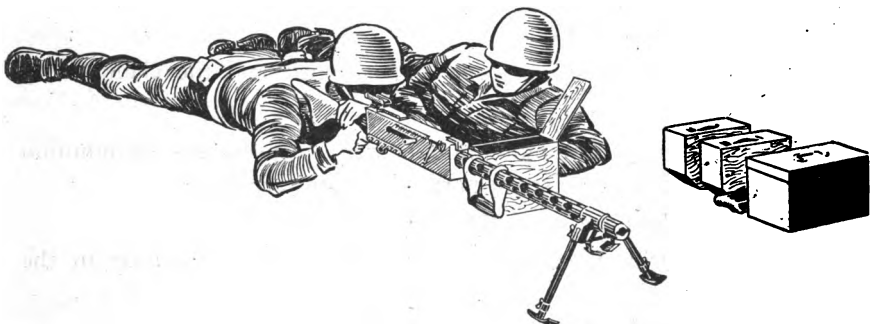


Figure 80. Gunner's position.

Small vertical adjustments are made by moving the elbows in and out. Large vertical adjustments are made by adjusting the bipod legs.

b. In gun drill, in the manipulation exercises of preparatory marksmanship and in instruction firing, the instructor will check frequently to see that the gunner is in the correct position.

## 66. To Put Gun Into Action

a. The squad leader indicates the point where the gun will be mounted and the general direction of fire by commands or signals. The commands are given and repeated in steps, and are: 1. GUN TO BE MOUNTED HERE (THERE), 2. DIRECTION OF FIRE TO YOUR FRONT (LEFT) (RIGHT), 3. ACTION. (The gunner repeats all commands, as follows: 1. GUN TO BE MOUNTED THERE (HERE), 2. DIRECTION OF FIRE TO MY FRONT (LEFT) (RIGHT), 3. ACTION.)

b. At this command, Nos. 1 and 2 proceed as follows:

### No. 1 (Gun)

*In the prone position.*

Springs to his feet.

Grasps the shoulder stock near the grip with his right hand and the carrying handle with his left hand.

Carries the gun at a run to the designated point.

Places the gun on the ground on the bipod and shoulder stock, the muzzle in the direction of fire.

Takes a prone position in rear of the gun with the shoulder stock placed on the right shoulder.

### No. 2 (Chests)

*In the prone position.*

Springs to his feet.

Grasps the spare parts chest and the spare barrel in his left hand and the ammunition box in his right hand and runs to the gun position so as to arrive as No. 1 is assuming the prone position, where he—

Places the spare parts chest, latch to the rear, 3 feet to the left of and on line with the muzzle of the gun.

Places the spare barrel in rear of the spare parts chest.

Places the ammunition box, latch toward the gun, in line with the feedway, ready for loading.

*Lies down* to the left of the gun, on his left side, feet to the rear, head in rear of the feedway. (See fig. 80.)



*No. 1 (Gun).—Cont'd*

Advances his right hand opposite the belt feed exit, and holds it in a position ready to grasp the tag of the belt.

Grasps the tag as it is pushed from the belt feed exit and gives it a quick jerk to the right.

Pulls the bolt handle to its rear-most position and *releases it*.

*Assumes the gunner's position.*

(See fig. 80.)

Calls, "Up."

*No. 2 (Chests).—Cont'd*

Opens the ammunition box.

Grasps with his right hand a fold of the belt at the point where the tag joins the fabric and pushes the tag through the feed opening as far as possible. He is responsible that the belt is straight and will feed properly, and that the cover of the gun is latched, insuring the latching by striking the cover with his right hand.

As soon as No. 1 has called, "Up," signals: READY.

- \* Crawls to the muzzle and, taking care not to get in front of the gun, adjusts the bipod leg tube extensions so that the barrel is level, or, if a fire order has been given, at the height necessary to aim at the target.

c. At the moment that No. 2 is assuming his position, No. 3 arrives at the gun position with his load, which he places in rear of the spare barrel, latches toward the gun.

d. When No. 4 is present, he passes his ammunition boxes to No. 3 who aligns them at his position, latches to the front.

**67. To Take Gun Out of Action**

a. The gun being in action, to take it out of action, the squad leader commands or signals: OUT OF ACTION.

b. At the command, Nos. 1 and 2 proceed as follows:

*No. 1 (Gun)*

*In the gunner's position.*

Pulls back the latch with his right hand.

Raises the cover to the half open position with his left hand.

*No. 2 (Chests)*

*Lying on the left of and facing the gun, legs to the rear.*

As soon as No. 1 raises the cover, lifts the belt and removes it from the feedway.

*No. 1 (Gun).—Cont'd*

Brushes his left hand across the top of the bolt to make sure the extractor is down.

Lowers the cover with his left hand.

Pulls the bolt handle to its rear-most position with his right hand and releases it.

Presses the trigger with his right forefinger.

Springs to his feet.

Grasps the shoulder stock near the grip with his right hand.

Grasps the carrying handle with his left hand.

Turns to the left about and carries the gun at a run to his original position.

Places the gun on the ground resting on the shoulder stock and bipod; cover up and muzzle to the left.

Inspects the gun to see that—

It is unloaded by pulling the bolt to the rear at least twice and releasing it.

The rear sight is set at 700 yards.

The sight leaf is lowered.

The windage gauge is set at zero deflection.

The trigger is pulled.

The front sight post is down.

Returns to the prone position.

*c.* At the command, No. 3 runs to the gun position, picks up two ammunition boxes, turns to the left about, and runs to his original position.

*d.* No. 4, if present, secures his ammunition boxes from the position of No. 3 and runs to his original position.

*No. 2 (Chests).—Cont'd*

Packs the belt in the ammunition box and latches the cover.

Springs to his feet.

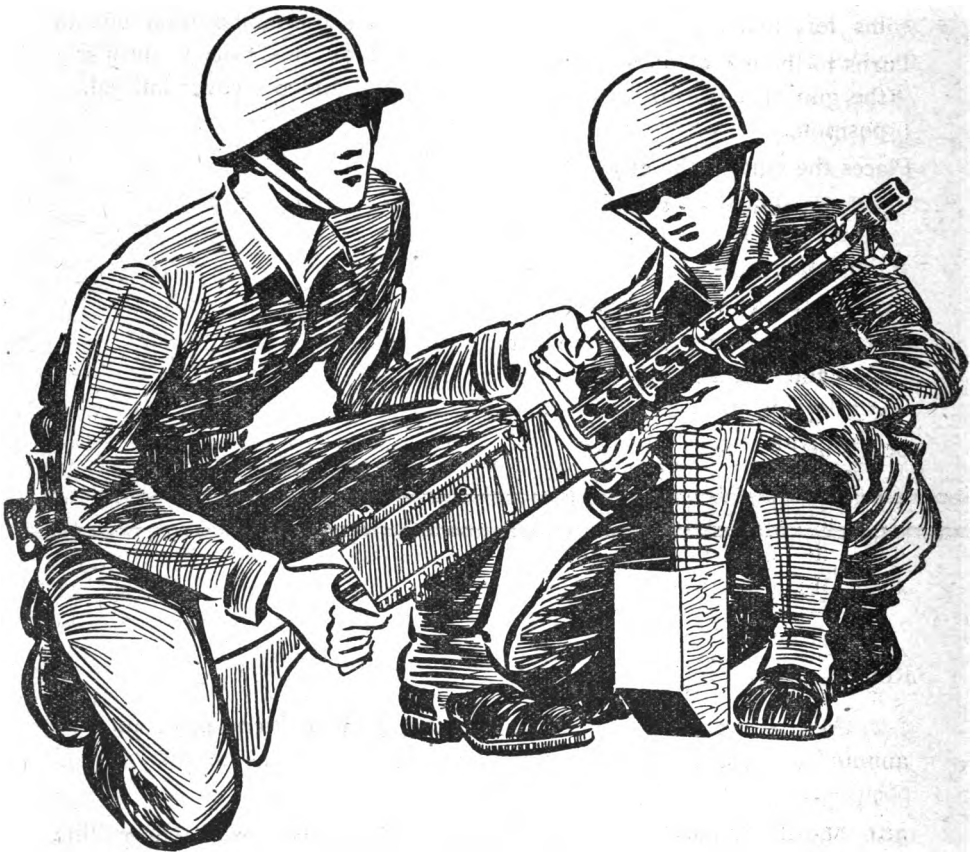
Picks up the ammunition box in his right hand and the spare barrel and spare parts chest in his left hand.

Turns to the left about and runs to his original position.

Resumes the prone position and inspects the ammunition box to see that the belt is properly packed and the cover latched.

**68. To Put Gun Into Action for Antiaircraft Fire (fig. 81)**

**a. GENERAL.** The M1919A6 machine gun can be used to engage hostile aircraft. The command is: 1. **ANTI-AIRCRAFT**, 2. **ACTION**. The following method is used: No. 1, with the left hand grasping the carrying handle and the right hand around the shoulder stock at the grip, with the index finger on the trigger, kneels on his right knee. The buttocks are dropped well down with the right buttock resting on the right heel. The left leg is pointed in the general direction of the target; the right knee about 45° to the right. The body is crouched well forward. The left forearm rests on the left knee for support. The right arm is held close to the body, the right hand holding the shoulder rest firmly against the ground between the legs. From this position, the gunner changes the direction of aim by twisting the body, moving the right knee and left foot if necessary. No. 2, from a kneeling position similar to the gunner's, holds the ammuni-



*Figure 81. Antiaircraft position.*

tion belt and keeps it in line with the feedway. The bipod leg tubes should be folded against the barrel jacket if time and the situation permit.

b. Under varying conditions in battle, expedients such as resting the barrel jacket in the fork of a tree or a notch in a wall, or over the limb of a tree, may be useful.

### 69. To Move Gun

Before movement is started, the squad leader commands: UNLOAD. The gun is unloaded and the belt placed properly in the chest. At the command: 1. TWO-MAN LOAD, 2. FOLLOW ME (TO SUCH-AND-SUCH POSITION), No. 1 grasps the shoulder stock in his left hand and the ammunition box in his right hand. No. 2 grasps the spare barrel and spare parts chest in his left hand, and the carrying handle with his right hand. When both are ready, No. 1 calls, "Up," and the men spring up and move off (carrying the gun with the muzzle leading), in the trace of the squad leader, or to the objective designated. As soon as Nos. 1 and 2 move off with their loads, No. 3 springs up and runs to the gun position, where he secures the two boxes of ammunition and moves off in the trace of the gun. No. 4, if present, springs up, secures his ammunition boxes from the position of No. 3, and moves off in the trace of No. 3.

## Section V. MEASURING AND LAYING OFF ANGLES

### 70. Manipulation of Gun

a. M1917A1 GUN. (1) By making use of the dial and the elevating and traversing mechanism, the gunner can measure and lay off horizontal and vertical angles.

(2) By using the clinometer (TM 9-575), quadrant elevation may be applied to the gun or may be determined after the gun has been laid.

(3) Habitually, before each manipulation of the gun, the elevating and traversing micrometers are set at zero, the gear housing is placed near the center of the traversing screw, and about  $\frac{1}{2}$  inch of the elevating screw threads are exposed above the gear housing.

(4) The elevating and traversing handwheels are always operated with the right hand.

b. M1919A4 GUN AND M1919A6 GUN MOUNTED ON THE TRIPOD, M2.

(1) By making use of the elevating and traversing mechanisms, the gunner can measure and lay off horizontal and vertical angles.

(2) Habitually, before each manipulation of the gun, the traversing gear housing is moved to the center of the traversing screw. The gunner grasps the grip with his right hand and the elevating handwheel with

his left hand. In traversing less than 25 mils, the gun is best moved by means of the traversing handwheel, operated by the left hand. The lay of the gun is best maintained with the right hand, the right arm being held rigid. In traversing over 25 mils, release the traversing slide lock lever with the thumb of the left hand and push the gun to the right or left, primarily with the left hand, assisted by the right hand on the grip, both elbows remaining on the ground. Manipulation of the gun in elevation is obtained by rotating the elevating handwheel with the left hand.

(3) Changes in elevation are read in mils on the micrometer dial on top of the elevating handwheel, and/or on the elevating screw scale, or by counting the number of 1-mil clicks as the wheel is turned. Changes in deflection are read on the mil scale on the traversing bar, or by counting the number of 1-mil clicks of the traversing handwheel.

(4) The traversing bar of the M2 tripod permits readings of 450 mils to the left or 425 mils to the right of the zero graduation. The elevating screw scale permits readings of plus 250 mils and minus 200 mils.

*c.* The greatest precision is demanded in all manipulations.

*d.* Ranges and angles are announced as follows:

(1) For numbers not multiples of 100, use digits. Examples: 150 as ONE FIVE ZERO; 135 as ONE THREE FIVE; 1,468 as ONE FOUR SIX EIGHT.

(2) For numbers not greater than 1,000 and which are multiples of 100, give range in hundreds. Example: 900 as NINE HUNDRED.

(3) For numbers greater than 1,000 and multiples of 100, use both digits and hundreds. Example: 1,100 as ONE ONE HUNDRED.

(4) For numbers which are multiples of 1,000 use thousands. Example: 2,000 as TWO THOUSAND.

## **71. To Use M1917A1 Machine Gun for Measuring Horizontal Angles**

*a.* TO ZERO DIAL. The gun being laid and clamped on a designated point, the command is: ZERO DIAL. The squad leader unclamps the traversing dial, turns the dial until the zero graduation is exactly opposite the index on the cradle pintle block, then clamps the dial.

*b.* Assume that the angle is to be measured between two horizontal points, *A* and *B*. The command is: MEASURE THE ANGLE FROM *A* (*B*) TO *B* (*A*).

*c.* No. 1 lays on the point *A* (*B*). If the index mark is large, use one edge to avoid errors. The squad leader assists, as necessary, by loosening and then tightening the traversing clamp. The gun being laid on the

designated point, the squad leader zeros the dial, then loosens the traversing clamp for No. 1, who turns the gun to the right (left) until it is aimed at the point *B* (*A*). The squad leader concludes the operation by tightening the traversing clamp.

(1) If the angle being measured is an exact multiple of 25, the index will rest exactly opposite one of the graduations on the dial. The squad leader reads and announces the angle measured, for example, if the index rests on 500, he announces, RIGHT (LEFT) FIVE HUNDRED, ADD ZERO.

(2) If the angle being measured is not a multiple of 25, the index will rest between two graduations of the dial after the gun has been turned from the first to the second point. For example, assume that the gun has been turned from *A* to *B* and that the index rests between 500 and 475. When this occurs, the operation is completed as follows: The squad leader turns the gun back by pushing on the water jacket until the index is opposite the lesser of the two graduations (475 in this case), tightens the traversing clamp and directs No. 1, COMPLETE THE LAY. No. 1 turns the *traversing handwheel* until the sights are again aligned on the point *B*, counting the clicks (mils) as he does so and verifying them by referring to the traversing micrometer. Assume the count to be 15. The squad leader announces the angle measured by the dial and that added by the micrometer as, RIGHT FOUR SEVEN FIVE, ADD ONE FIVE.

*d.* Horizontal angles of less than 25 mils are measured with the traversing handwheel and the micrometer.

## 72. To Use M1919A4 and M1919A6 Machine Guns for Measuring Horizontal Angles

Assume that the angle is to be measured between two horizontal points *A* and *B*. The command is: MEASURE THE ANGLE FROM *A* (*B*) TO *B* (*A*).

*a.* USING TRAVERSING BAR. If the angle to be measured is less than 450 mils right or 425 mils left (total 875 mils), No. 1 can read the angle from the scale on the traversing bar.

*Note.* If the angle is to be the right, the reading on the transversing bar is to the left, and vice versa.

*b.* USING TRAVERSING HANDWHEEL. If the angle to be measured is approximately 25 mils or less, No. 1 can read the angle from the scale on the traversing micrometer.

*c.* USING WINDAGE GAUGE. If the angle to be measured is less than 10 mils, No. 1 can read the angle from the scale on the windage gauge.

### **73. To Use M1917A1 Machine Gun for Laying Off Horizontal Angles**

The gun being laid and clamped on a designated point—

*a.* To lay off to the right (left) an angle which is a multiple of 25 mils, the command is, for example: RIGHT (LEFT) SIX HUNDRED, ADD ZERO. The squad leader zeros the dial, loosens the traversing clamp, turns the muzzle to the right (left) until the index is opposite the 600 mil graduation on the dial, and then tightens the traversing clamp.

*b.* To lay off to the right (left) an angle which is not a multiple of 25 mils, such as right 692 mils, the command is: RIGHT SIX SEVEN FIVE, ADD ONE SEVEN. The squad leader executes right 675 mils in the manner prescribed in *a* above. No. 1 then moves the muzzle an additional 17 mils to the right by turning the traversing handwheel, counting 17 clicks (mils) as he does so.

### **74. To Use M1919A4 and M1919A6 Machine Guns for Laying Off Horizontal Angles**

*a.* The gun being laid on a designated point with the traversing clamp at zero, No. 1 loosens the traversing bar clamp, and rotates the muzzle of the gun in the desired direction until the index on the traversing clamp is opposite the 5 mil graduation of the traversing bar nearest the desired reading. The traversing bar clamp is then tightened. Additional adjustment is made by means of the traversing handwheel.

*b.* If the size of the angle to be laid off is more than 450 mils right or 425 mils left, but not more than 875 mils, it can be done by laying the gun initially with the traversing clamp at one end of the traversing bar.

### **75. To Put Out Base and Aiming Stakes**

*a.* Distinctive stakes are often used to mark the direction of the gun with reference to its respective targets. The *base* stake, usually painted with alternate black and white stripes, marks the direction of the primary target. Aiming stakes, each painted preferably with a different color for each task, mark the direction of other targets.

*b.* The gun being pointed in the desired direction, the command is: BASE (RED, WHITE, BLUE) STAKE OUT. No. 1 sets the rear sight at its maximum elevation and the windage gauge at zero. No. 3, with a shovel and the designated stake, moves to the front about 20 yards. Under the direction of No. 1, he places the stake in the line of aim, with the narrow edge toward the gun, drives it into the ground, and then moves to his original position in rear of the gun. The stake is driven below the lowest probable elevation for firing so that it will not be shot down during the delivery of fire.

*c.* The base stake having been put out, the gun may be laid on it at any time by the command: LAY ON BASE STAKE. In indirect lay-

ing, when direction must be established accurately from computed data, the gun is first laid on the base stake with the sight set at the maximum elevation and the windage gauge at zero, and the computed angle(s) of shift then laid off from the base stake.

*d.* The gun is laid on any particular aiming stake by the command: LAY ON RED (WHITE, BLUE) STAKE.

#### **76. To Use M1917A1 Machine Gun for Measuring Vertical Angles**

The gun being laid and clamped on a point, *C*, to measure the vertical angle to another point, *D*, the command is: MEASURE THE ANGLE FROM *C* TO *D*. He measures the angle as follows:

*a.* FOR ANGLES LESS THAN 25 MILS. No. 1 turns the elevating handwheel and, if necessary, the traversing handwheel, until the sights are aligned on *D*. He counts the number of clicks through which the elevating handwheel was turned and by noting the readings on the micrometer.

*b.* FOR ANGLES OF 25 MILS OR GREATER. Notes the reading on the elevation arc for *C*, using the sharp edge of the cradle clamping collar body as an index. If a graduation on the elevating arc is not exactly opposite the index, he loosens the cradle clamping handle and elevates (depresses) the gun slightly until the nearest graduation on the arc is exactly opposite the index. He then elevates (depresses) the gun by means of the elevating handwheel until it is laid exactly on *C*. He next loosens the cradle clamping handle and elevates (depresses) the gun until it is laid on *D*, if one of the 25-mil graduations on the elevation arc is exactly opposite the index, or just below (above) *D* or if such matching of a 25 mil graduation with the index will not occur when the gun is laid on *D*. In the first instance, he notes the initial reading on the elevation arc, and takes the difference between it and the second reading as the difference in elevation of *C* and *D*. In the second instance, he operates the elevating handwheel until the gun is laid on *D*, counting the clicks and noting the readings on the micrometer. The combination of the number of these clicks (or readings) with the difference between the two readings on the elevation arc is the difference in the elevation of *C* and *D*.

*c.* The squad leader announces the angle, for example: UP (DOWN) ONE EIGHT (FIVE SEVEN).

#### **77. To Use M1919A4 and M1919A6 Machine Guns for Measuring Vertical Angles**

The gun being laid and clamped on a point, *C*, to measure the vertical angle to another point, *D*, the command is: MEASURE THE ANGLE FROM *C* TO *D*. No. 1 turns the elevating handwheel, and, if necessary,



the traversing handwheel, until the gun is laid on point *D*. He measures the angle as follows:

*a.* FOR ANGLES LESS THAN 50 MILS. No. 1 turns the elevating handwheel and, if necessary, the traversing handwheel until the sights are laid on *D*. He counts the number of clicks through which the elevating handwheel was turned.

*b.* FOR ANGLES OF 50 MILS OR GREATER. Reads the changes on the scale of the elevating screw for multiples of 50 mils and counts the number of additional clicks (mils) through which the elevating handwheel is turned, as described in *a* above, beyond the last of such 50 mil changes. In either case, he verifies the measured angle by checking the reading shown on the scale of the elevating screw and the elevating micrometer dial when laid on both points *C* and *D*. The difference in these readings is the desired measurement.

*c.* ANNOUNCEMENT OF ANGLE. The squad leader announces the angle, for example: UP (DOWN) ONE EIGHT (FIVE SEVEN).

#### **78. To Use M1917A1 Machine Gun for Laying Off Vertical Angles**

The gun being laid on the designated point, the command is, for example: UP (DOWN) ONE ZERO (FIVE EIGHT). No. 1 turns the elevating handwheel and/or loosens the cradle clamp until the muzzle has been elevated (depressed) the required number of mils. He verifies the number of mils as in paragraph 76.

#### **79. To Use M1919A4 and M1919A6 Machine Guns for Laying Off Vertical Angles**

The gun being laid on the designated point, the command is, for example: UP (DOWN) TWO FOUR (SIX NINE). No. 1 turns the elevating handwheel until the muzzle has been elevated (depressed) the required number of mils. He verifies the number of mils as in paragraph 77.

#### **80. To Measure Quadrant Elevation**

The gun being laid with the correct sight setting, the command is: MEASURE QE. The squad leader sets the clinometer on the top of the receiver, to the right of and alongside the latch, with the M1917A1 gun or on top of the cover with the M1919A4 and M1919A6 guns, with the arc to the rear if the muzzle is elevated (to the front, if the muzzle is depressed). Without disturbing the laying of the gun, he adjusts the plunger index and the level holder index until the bubble is centered. He notes the reading and announces the QE, giving the number of his gun, as, No. 2, QE PLUS FOUR EIGHT (MINUS FOUR).

### **81. To Apply Quadrant Elevation**

An example of the command is: **QE, PLUS (MINUS) THREE FIVE.** The squad leader sets the clinometer at the announced quadrant elevation, places it as described in paragraph 80, and elevates (depresses) the muzzle until the clinometer bubble is centered. As soon as the squad leader places the clinometer on the receiver, No. 1 steadies it until it is removed by the squad leader.

## **Section VI. BATTERY DRILL**

### **82. General**

a. The object of battery drill is to train the platoon to emplace guns in battery and to apply indirect laying data promptly and accurately. *Instruction in battery drill should immediately precede indirect laying.* (See ch. 8.)

b. The battery may consist of two or more guns. The usual unit which executes battery fire is the platoon.

c. Although the light guns mounted on tripods may be used for battery fire, they are not ordinarily so used because of the limitations in steadiness of the mounts.

### **83. To Designate Battery Position**

a. The platoon with its transportation is conducted as close to the position to be occupied as cover permits.

b. Squad leaders are conducted to the position and given the following information:

(1) General direction of fire.

(2) Flanks of the battery position (usually about 100 yards apart).

(3) Interval (approximately equal) between guns. If both flanks of the battery are not marked on the ground, one flank and the direction in which the battery will extend are pointed out.

### **84. To Secure Equipment for Going Into Battery**

a. Each squad leader commands: **SECURE EQUIPMENT.**

b. At this command, the equipment prescribed in paragraph 46, supplemented by the following articles, is secured:

(1) Base and aiming stakes by No. 3.

(2) Shovel by No. 4.

c. Having secured its equipment, the squad moves in a squad column to the gun position.

### 85. To Put Gun Into Battery

Each squad leader indicates the exact point where the gun will be emplaced and the general direction of fire, and commands: 1. IN BATTERY, 2. ACTION. At this command, Nos. 1, 2, and 3 mount and emplace the gun.

### 86. To Emplace Gun

In order to insure maximum accuracy, as well as to protect friendly troops which may be near the line of fire, the gun must be emplaced firmly. If the tripod is mounted on soft ground, its vibrations during the delivery of fire will cause it to dig in. On the other hand, an unyielding surface, such as rock, will absorb no vibration, and thus cause undue dispersion. To insure steadiness, the trail shoe is floated on a small board about 4 inches wide, 7 inches long, and  $\frac{1}{2}$  to  $\frac{3}{4}$  inch thick. (See fig. 82.) To float the trail shoe, dig a small hole the size of the board under the trail shoe. Place the board in the hole and fit it into the angle formed by the two surfaces of the trail shoe with the flat side flush against the horizontal surface of the trail shoe and the extension of the trail leg. Hold the board in this position and tamp dirt, preferably moistened, under and around the float to insure a solid support for the trail shoe. The tripod must be adjusted so that the dial is level before floating the trail leg.

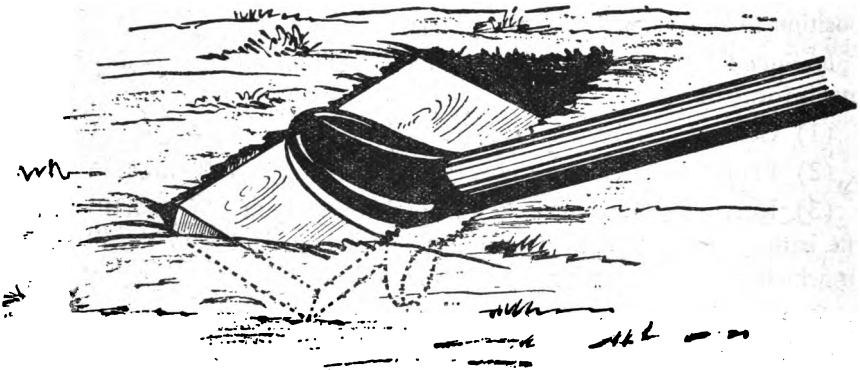


Figure 82. Floating the trail shoe, M1917A1 machine gun.

### 87. To Lay On Initial Aiming Point (fig. 83)

The initial aiming point (IAP) having been designated by any convenient method of target designation, the command is: LAY ON IAP. The squad leader loosens the traversing clamp. No. 1 sets the rear sight at its maximum elevation and the traversing micrometer and the windage

gauge at zero deflection, centers gear housings, then lays the gun on the IAP. The squad leader tightens the traversing clamp and zeros the dial.

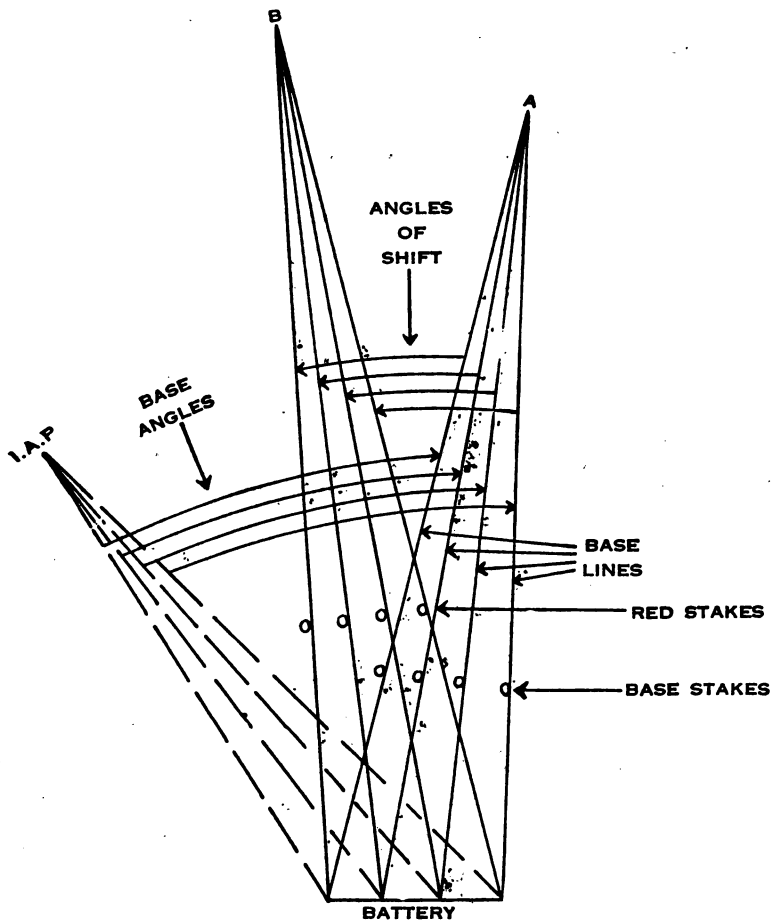


Figure 83. Laying the battery for direction.

### 88. To Lay Off Base Angles and Establish Base Lines

a. The battery being laid on the IAP, the base angle (angle IAP-Gun-Task A, fig. 83) of each gun is announced and established by commands similar to the following:

- NO. 1—RIGHT SEVEN FIVE ZERO, ADD TWO ZERO.
  - NO. 2—RIGHT SEVEN FIVE ZERO, ADD ONE ZERO.
  - NO. 3—RIGHT SEVEN FIVE ZERO, ADD ZERO.
  - NO. 4—RIGHT SEVEN TWO FIVE, ADD ONE FIVE.
- BASE STAKES OUT.

b. Each gun crew lays off the horizontal angles announced, and on the new line of sighting, sets out a base stake. The lines thus established are the base lines—the direction of fire of each gun for the priority target (task A). (See pars. 73 and 75.) As soon as the base lines are established, the dial and traversing micrometer of each gun are zeroed on the base line of that gun. All subsequent angles (angles of shift) are then measured from the base lines.

### 89. To Lay Off Angles of Shift

a. The guns being laid on their base lines, the angles of shift to point the guns in direction for their second target (task B) are next announced and established by commands such as the following:

NO. 1—LEFT TWO TWO FIVE, ADD ONE NINE.

NO. 2—LEFT TWO TWO FIVE, ADD TWO TWO.

NO. 3—LEFT TWO FIVE ZERO, ADD ZERO.

NO. 4—LEFT TWO FIVE ZERO, ADD THREE.

RED STAKES OUT.

b. Each crew lays off the horizontal angle announced, and sets out a red stake on a new line of sighting.

### 90. To Lay Guns for Elevation

Being laid for direction on any set of stakes, the guns are next laid for elevation by applying the quadrant elevation as prescribed in paragraph 81.

### 91. Ammunition Supply

As soon as possible, the platoon leader announces the number of boxes for each task. No. 3 segregates the various amounts and supplies the gun.

### 92. Battery Exercises

a. GENERAL. Precision having been attained, the crews are trained in the rapid establishment of direction lines and in simulated firing of a series of tasks. The drill is ordinarily conducted by command. In shifting from one task to another, at least 1 minute should be allowed to effect the changes in direction and elevation.

b. EXAMPLES OF TASK ORDERS.

IAP, TO YOUR LEFT FRONT, STEEPLE.

LAY ON IAP.

c. EXAMPLES OF FIRE ORDERS.

(1) PREPARE FOR FIRE ORDER.

LAY ON BASE STAKES.

BOXES PER GUN: FOUR.

QE: PLUS EIGHT FOUR.  
TRAVERSE RIGHT THREE TWO.  
RAPID.  
UPON SIGNAL.

- (2) PREPARE FOR FIRE ORDER.  
LAY ON RED STAKES.  
BOXES PER GUN: SIX.  
QE: PLUS ONE ZERO NINE.  
TRAVERSE RIGHT THREE SIX.  
SEARCH UP EIGHT.  
MEDIUM.  
UPON SIGNAL.

d. EXECUTION OF FIRE ORDERS. (1) Battery fire is used in indirect laying. At the command: PREPARE FOR FIRE ORDER, each gunner moves the gear housing to the right end of the traversing screw in order to permit the maximum amount of traverse to the right during the delivery of fire (occasionally the traverse may be to the left). At the command: LAY ON BASE (RED, WHITE, BLUE) STAKES, each gunner lays his gun on the designated stake. For a discussion of the methods used in executing fire orders, see chapter 8.

(2) Search, when required, is always "Up" in battery drill. Both searching up and down may be performed in other types of firing.

(3) When an area target with depth is engaged, direction and elevation for each task are checked on the lower traverse only.

(4) *To fire on task A (based on example (1) of fire order under c above).* At the command: LAY ON BASE STAKES, each No. 1 lays on his base stake. At the same time, each No. 3 brings forward the allotted ammunition. As soon as the guns have been established in direction, each squad leader applies the quadrant elevation (plus 84). Upon the signal: COMMENCE FIRING, each No. 1 fires a burst, traverses 4 mils to the right, fires a second burst, and continues the operation until he has traversed the gun through 32 mils in moves of 4 mils each. At the completion of the right traverse, each squad leader checks the QE, and each No. 1 traverses 32 mils to the left in moves of 4 mils each, firing a burst after each traverse. He then relays on the stake and the squad leader checks the QE. The procedure is repeated until the prescribed ammunition has been expended, or CEASE FIRING is given. If fire has been adjusted by the observers so that either or both the original direction and elevation have been changed, the checks referred to above should be made with reference to the new adjustments.

(5) *To fire on task B (based on example (2) of fire order under c*

*above.* At the command: LAY ON RED STAKES, each gun is laid on its red stake and elevated (QE plus 109), No. 1 fires a burst, traverses once to the right (36 mils) in moves of 4 mils each, firing a burst after each traverse; he traverses back quickly to the left, relays on the red stake and resets the gun in elevation as prescribed above for task A. The squad leader then commands: UP EIGHT. The gunner clicks up 8 mils, fires a burst, traverses 36 mils to the right in moves of 4 mils each, firing a burst after each traverse. After traversing across the upper square, the gun is relayed on the aiming stake, the squad leader checks the QE, and the entire operation is repeated until the prescribed ammunition has been fired or CEASE FIRING is given. As explained above, it will be noted that search is always "Up," and that direction and elevation are checked on the lower traverse only. If fire has been adjusted by the observers so that either or both the original direction and elevation have been changed, the checks referred to above should be made with reference to the new adjustments.

*e.* FIRING BY CHART. Instead of using commands, the fire of the battery may be directed and controlled by the use of charts. Each gun has a chart upon which are entered the time and all data (from the battery chart (see fig. 125②)) necessary for the gun to fire upon any target. The firing may be executed by a time schedule or by command. In the latter case, at the command, TASK A (B), the guns are laid for that task according to the data on their respective charts and fire is opened upon the command or signal of the battery commander.

---

## CHAPTER 3

### MARKSMANSHIP

---

#### Section I. GENERAL

#### 93. Scope

This chapter prescribes courses of instruction, rules, and regulations for the conduct of machine gun marksmanship.

#### 94. Fundamentals

*a.* To become accurate and proficient in machine gun marksmanship, the soldier must be thoroughly trained in the following fundamentals:

- (1) Accurate delivery of the initial burst of fire.
- (2) Mechanical skill in manipulating the gun.
- (3) Adjustment of fire by the following methods:
  - (*a*) Observation of strike.
  - (*b*) Observation of flight of tracer bullets.
  - (*c*) Frequent relaying of the gun during firing.
- (4) Speed in combining the above-mentioned three elements in delivering fire.

*b.* All men must be coached properly and all errors explained and corrected immediately, otherwise these errors will tend to develop into faulty habits.

#### 95. Prior Training

The soldier should be proficient in mechanical training and drill before he receives instruction in machine gun marksmanship.

#### 96. Method of Instruction

*a.* The officer in charge of conducting the training will act as instructor. He will be aided by assistant instructors, who will usually be the leaders of the various units undergoing instruction. Other specially selected men may also be used for this duty. Platoon and section leaders act as



assistant instructors to organize and supervise the instruction within their respective units. Squad leaders act as squad instructors and conduct the instruction at their respective guns. It is essential that assistant instructors be thoroughly trained in their duties before group instruction is commenced.

*b.* Each exercise is first explained and demonstrated to all men undergoing instruction. Each man is then given practical work in the exercise. This is supervised by the assistant instructors, under the supervision of the instructor. Finally, the men are given an examination in order to determine their progress or proficiency.

*c.* The coach-and-pupil method will be used wherever practicable. Under this method, men are grouped in pairs and take turns in coaching each other. The man undergoing instruction is called the pupil, and the man giving instruction, the coach.

*d.* A squad is the largest unit in which individual instruction can be closely supervised. If a sufficient number of machine guns are available, it is preferable to assign a squad instructor and three men to each gun.

## Section II. PREPARATORY EXERCISES

### 97. General

*a.* The purpose of the preparatory exercises is to develop in the soldier fixed and correct habits of marksmanship. A thorough, carefully supervised course in these exercises will conserve time and ammunition during range practice.

*b.* The preparatory exercises consist of the following steps:

(1) Sighting and aiming exercises.

(2) Sight setting and laying exercises.

(3) Manipulation exercises, including correct position and grip.

(4) Range estimation.

(5) Observation and adjustment of fire.

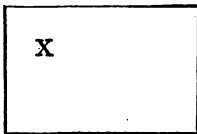
(6) Examination of men before starting range practice. Exercises should be taught in the sequence listed above.

*c.* Every man who is to fire on the range, including those who have previously qualified, will receive complete instruction in the preparatory exercises. The instructor will cause each man to be tested thoroughly and graded in the exercises shown on the progress chart before he is allowed to fire. Men whose rating is unsatisfactory will be given additional instruction until their rating is satisfactory. The progress made

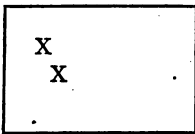
Each man in the preparatory exercises should be recorded on the following form:

Names	Subjects										
	First sighting and aiming exercise	Second sighting and aiming exercise	Third sighting and aiming exercise	Fourth sighting and aiming exercise	Sight setting and laying exercise	Manipulation exercise, traversing	Manipulation exercise, searching	Manipulation exercise, combined traversing and searching	Range estimation	Adjustments of fire	Windage correction
Grades											

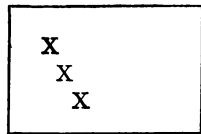
Method of grading:



Unsatisfactory



Satisfactory



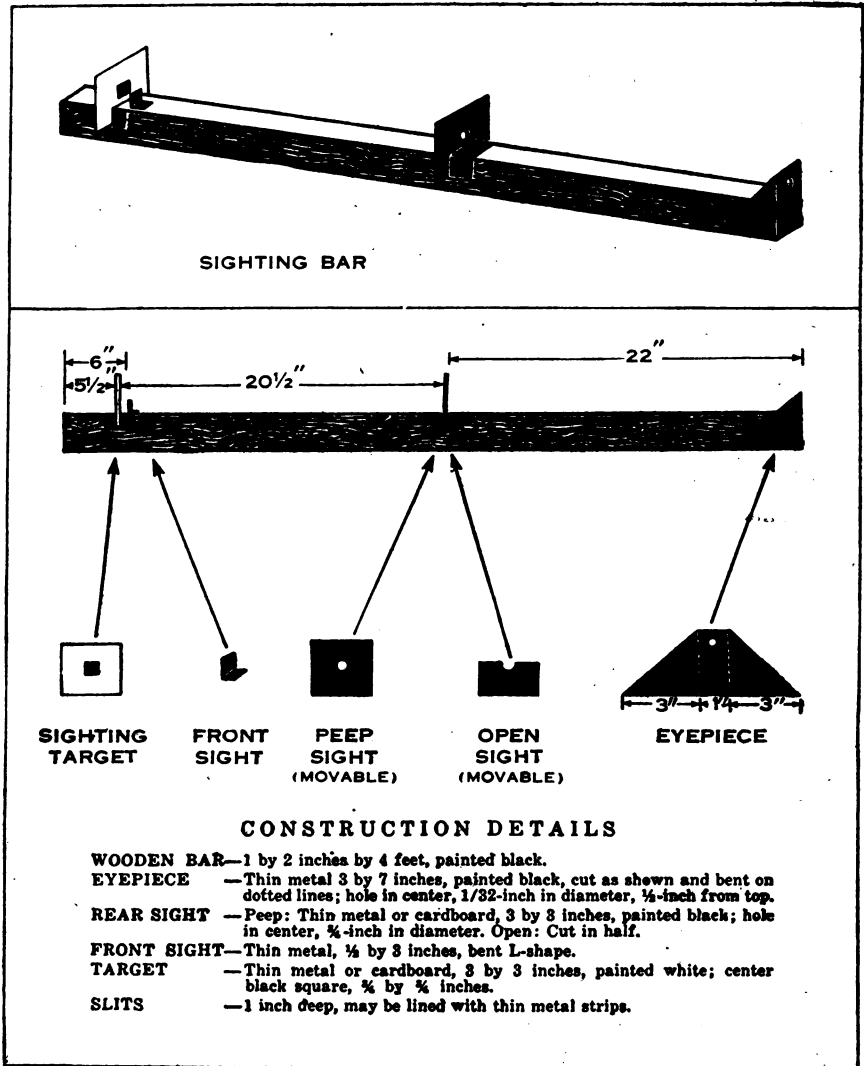
Satisfactory and has instructional ability

**98. Equipment for Each Squad**

The following squad equipment is required for the preparatory exercises:

- a. One machine gun and mount, complete; preferably two guns and mounts, complete, if available.

- b. Two sighting bars, complete. (See fig. 84.)
- c. One 3-inch sighting target (fig. 85), or one 1-inch sighting target per gun.
- d. One target frame, 3 by 5 feet, per gun, covered with blank paper and equipped with braces for mounting on the ground.
- e. One 1,000-inch machine gun manipulation target per gun.
- f. Material for blackening sights. (See par. 114f.)
- g. One lead pencil per gun.



*Figure 84. Sighting bar.*

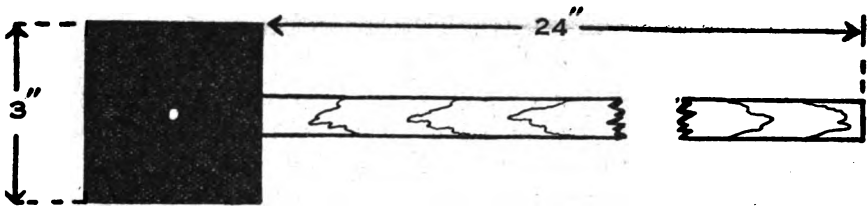


Figure 85. Three-inch sighting target.

h. Four sheets of tracing or tissue paper per gun for copying triangles.

### 99. First Sighting and Aiming Exercise

a. The purpose of the first sighting and aiming exercise is to teach correct alignment of the sights on a target.

b. The instructor explains and illustrates by blackboard or chart the correct sight alignment. (See fig. 86①.) When the top center of the front sight is in the center of the peep sight, the sights are said to be correctly aligned.

c. The instructor then explains and illustrates a correct aim. A correct aim is one in which the sights are correctly aligned, with the top of the front sight just touching the bottom of the target, and with the target centered on the front sight. (See fig. 86②.)

d. The instructor exhibits a sighting bar (fig. 84), points out its parts, and explains its use as follows:

(1) The sighting bar is used because it assists in detecting small errors and in explaining them to the man undergoing instruction.

(2) The front and rear sights on the sighting bar represent enlarged machine gun sights.

(3) The eyepiece causes the soldier to place his eye in such a position that he sees the sights in exactly the same alignment as they are observed by the squad instructor or coach. Although there is no eyepiece on the machine gun, the use of an eyepiece on the sighting bar assists the soldier in learning how to align his sights properly when using the machine gun.

(4) The attachment of the removable target to the end of the sighting bar provides a simple method of readily aligning the sights on the target.

(5) The eye should be focused on the top of the front sight to insure that the line of aim is a line through the center of the peep sight and over the center of the top of the front sight. A slight error in centering the front sight in the peep sight will cause a large error on the target. Having obtained a correct sight alignment, the eye is then focused on the target to insure a correct aim.

e. The instructor then selects four men to demonstrate the exercise as follows:

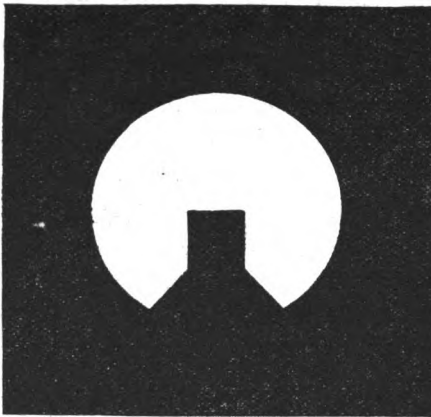
(1) One man, acting as group instructor, explains the correct sight alignment, using a diagram similar to figure 86①. He next adjusts the movable rear sight on the sighting bar to illustrate the correct sight alignment. The top edge of the front sight should fall on the horizontal diameter of the peep sight. There should be an equal amount of space on both sides of the front sight. Thus, the center of the top edge of the front sight is in the *exact center* of the peep sight. He has each pupil examine the setup.

(2) He sets off small errors in alignment and requires the pupils to detect and correct the errors noted.

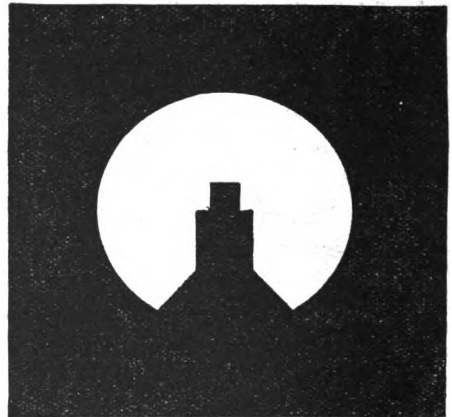
(3) The group instructor illustrates a correct aim, with the movable target placed so that the bottom edge of the target meets the top edge of the front sight in the *exact center* of the peep sight, and has each pupil examine it. (See fig. 86②.)

(4) He adjusts the rear sight and movable target to illustrate small errors, and has the pupils detect and correct them.

(5) Each man is then required to adjust the sighting bar for correct aim until he is proficient.



① Correct sight alignment.



② Correct sight picture.

Figure 86. Correct aim.

### 100. Second Sighting and Aiming Exercise (fig. 87)

a. The purpose of the second sighting and aiming exercise is to apply the preceding lesson to the actual alignment of machine gun sights on a target.

b. The instructor makes the following explanation, which is demonstrated simultaneously by a demonstration group:

(1) One man as squad instructor takes the normal gunner's position, keeping his body and hands clear of the gun, with his eye in the correct position for aiming. When the M1919A6 gun is used, it should be mounted without the shoulder stock, on the M2 tripod.

(2) The pupil takes position near the gun where he can observe the squad instructor.

(3) A third man is posted near the gun to transmit signals to the marker.

(4) The marker is provided with a 3-inch sighting target and is posted at the blank target, which is placed 100 yards from the gun. (A 1-inch sighting target may be used at 1,000 inches from the gun pintle.)

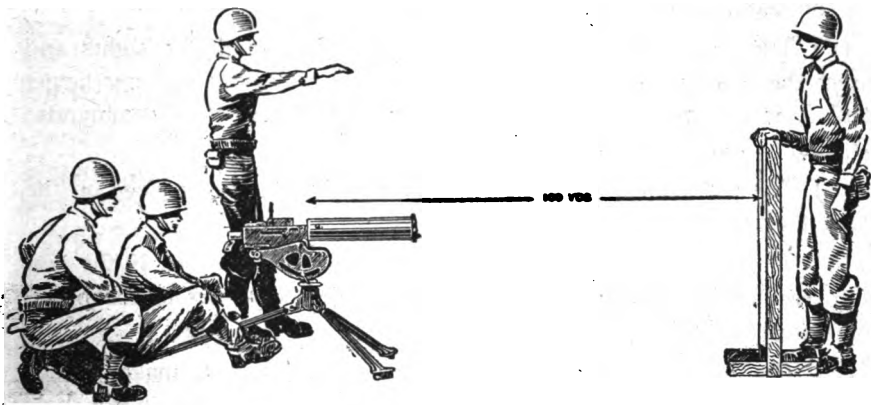


Figure 87. Shot group exercise.

(5) The squad instructor, by improvised signals transmitted through the signal man, directs the marker to move the sighting target until it is in correct alignment with the sights, and then commands: HOLD.

(6) The marker complies, holding the sighting target in place on the blank target.

(7) The squad instructor has the pupil take position at the gun and look through the sights.

(8) After the pupil has looked through the sights, the squad instructor directs the marker to move the sighting target slightly out of alignment and then requires the pupil to direct the marker, through the signal man, to move the sighting target until it is in correct alignment with the sights.

(9) The squad instructor checks the alignment made by the pupil and points out any errors.

c. The men return to their equipment and, under supervision of the squad instructor, repeat the exercise until each man has acted as a pupil.

### 101. Third Sighting and Aiming Exercise (fig. 87)

a. The purpose of the third sighting and aiming exercise is to show the importance of uniform and correct aiming, and to instill into the mind of the soldier a sense of exactness.

b. The instructor emphasizes the importance of exact and uniform aiming and conducts the following demonstration with a demonstration group:

(1) One man as squad instructor organizes the demonstration group as for the second sighting and aiming exercise, with the pupil in position at the gun. When the M1919A6 gun is used, it should be mounted without the shoulder stock, on the M2 tripod.

(2) The squad instructor has the pupil look through the sights and direct the marker, through the signal man, to move the sighting target until it is in correct alignment with the sights, and then commands: HOLD.

(3) The marker complies, holding the sighting target in place on the blank target.

(4) The squad instructor looks through the sights to see if the aim is correct or incorrect and then, without saying anything to the pupil, commands: MARK.

(5) The marker, without moving the sighting target, makes a dot on the blank target with a sharpened pencil inserted through the hole in the center of the sighting target. He numbers this dot "1." He then moves the sighting target out of alignment.

(6) The pupil and squad instructor, without touching the gun or mount, repeat the operation described above until three dots have been made and numbered.

(7) The squad instructor explains the errors noted in the three sight alignments and the probable shape of the shot group formed by joining the three dots.

(8) The marker traces the three dots on a sheet of tracing or tissue paper, connects them with lines, writes the pupil's name at the bottom of the sheet, and hands the paper to the squad instructor. The squad instructor discusses the size and shape of the shot group and points out errors.

(9) At 100 yards with the 3-inch sighting target a gunner should be able to place all three dots so that they can be inclosed in a circle

having a diameter of 1 inch. At 1,000 inches with the 1-inch sighting target the diameter of the circle should not be over  $\frac{1}{4}$  inch.

c. The men return to their equipment and, under supervision of the squad instructor, repeat the exercise until each man has made a satisfactory shot group.

### 102. Fourth Sighting and Aiming Exercise

a. The purpose of this exercise is to demonstrate the effect of canting the gun, which may be caused by mounting the gun on uneven or sloping ground.

b. The instructor explains that if the gun is canted to the right, the bullet will strike to the right and below the point aimed at, even though the gun is otherwise correctly aimed and the sights correctly set. Similarly, if the gun is canted to the left, the bullet will strike low and to the left. It should be understood however that canting, unless pronounced, will not materially affect the aim or strike of the burst at *short ranges*.

c. The men return to their equipment, where the squad instructor mounts the gun on uneven ground so that its traverse will not be in a horizontal plane. He then requires each soldier to point out the error, explain its effect on the fire of the gun, and then make the necessary corrections.

### 103. Sight Setting Exercise

a. The purpose of the sight setting exercise is to teach the use of the rear sight and to develop accuracy and speed in its use.

b. Using a large drawing of figure 2 or 4 (rear sight), the instructor points out the parts of the rear sight and explains its use as follows:

(1) *M1917A1 gun*. The sight slide is set at the desired range graduation on the sight leaf by loosening the thumb nut and then placing the heels of the hands against the receiver. With the thumb nut loosened, press it in with the thumb and forefinger of the right hand, at the same time pressing with equal pressure against the left side of the sight slide with the thumb and forefinger of the left hand. The movement of the sight slide is accomplished by a movement of the fingers only, the heels of the hands remaining steadied against the sides of the receiver. The sight slide having been set, pressure is released on the thumb nut and it is tightened. The tips of the adjusting plate blade are used as the index for the sight setting.

(2) *M1919A4 and M1919A6 guns*. The sight slide is set at the desired range graduation by turning the elevating screw knob. The shoulders



of the sight slide, not the hair line through the peep sight, should be used as an index in setting the sight at the desired graduation.

(3) *All guns.* The windage scale of the sight on the M1917A1 gun is graduated in 1-mil increments, while that on the M1919A4 and M1919A6 guns is graduated in 5-mil increments. If the pupil moves the index to the right 1 mil (click) and relays the gun, he will move the point of strike of the bullet 1 mil to the right, or 1 inch at a distance of 1,000 inches.

c. To demonstrate the exercise, the instructor has one man, as pupil, take position at the gun and another man, as squad instructor, take position to the right of the gun. The exercise is demonstrated as follows:

(1) The instructor announces the range and deflection, for example: **RANGE EIGHT HUNDRED, SIGHT RIGHT FIVE.**

(2) The pupil repeats the command, sets the sight at the announced range, and turns the windage screw knob until the index is at "right five." He then takes the correct gunner's position and reports, "Up."

(3) The squad instructor checks the setting of the slide and the windage gauge and points out any errors.

d. The men return to their equipment and, working in pairs, go through the exercise until all are proficient in rapid and accurate sight setting.

#### **104. Sight Setting and Laying Exercise**

a. The purpose of the sight setting and laying exercise is to develop speed and accuracy in setting the sights and laying the gun on an aiming point.

b. The instructor explains that the exercise starts with the sight leaf down and the slide set at 700, that ranges less than the zeroing elevation or greater than 1,400 yards will not be announced, and that, in aiming, the middle point of the lower edge of the aiming paster is used as the aiming point.

c. To demonstrate the exercise, the instructor has one man, as pupil, take position at the gun; and another man, as squad instructor, take position to the right of the gun. He demonstrates the exercise as follows:

(1) The instructor announces a range and aiming point by giving a command similar to the following: 1. **RANGE EIGHT HUNDRED, SIGHT RIGHT THREE,** 2. **PASTER NO. 5.** After giving the first element of the command, the instructor pauses long enough to permit the pupil to repeat it.

(2) The pupil repeats the first element of the command, raises the sight leaf, and sets the sight.

(3) While the pupil is setting the sight, the instructor announces the second element of the command.

(4) The pupil repeats the second element of the command and, upon completing the sight setting, manipulates the gun by turning the traversing and elevating handwheels until the sights are accurately aligned on the designated aiming point. He then takes the correct gunner's position and announces "Up."

*d.* The squad instructor performs the following duties:

(1) Watches the manipulation of the gun by the pupil to see that it is done correctly, smoothly, and without hesitation.

(2) Sees that the pupil takes the correct gunner's position, paying particular attention to the grip.

(3) Checks the sight setting and the laying at the completion of the exercise.

(4) Notes the time used by the pupil for the exercise.

(5) Points out any errors.

*e.* The men return to their equipment, and instruction is continued until each man becomes proficient in setting the sight and laying the gun accurately within a time limit of 10 seconds.

*f.* Men equipped with the M1919A6 gun should become proficient as stated in *e* above with the gun mounted on the M2 tripod and on the bipod.

## 105. Manipulation Exercises

*a.* Fire in combat is not limited to a point target. Targets usually have width or depth, and frequently both. It is therefore necessary to develop accuracy and speed in manipulating a machine gun so as to cover the entire target.

*b.* The instructor insures that the following instructions are understood and observed by the group:

(1) A manipulation target (fig. 88) is placed 1,000 inches from the gun pintle; thus a change of 1 mil in either deflection or elevation will change the point of aim 1 inch on the target.

(2) Traversing and searching are accomplished by means of the traversing and elevating handwheels. A click on either of the handwheels changes the direction of the gun 1 mil. In a combined traversing and searching exercise, the traverse is made before the search. Before firing the 1,000-inch machine gun target, the gunner checks the recorded deflection zero of the weapon with the windage adjustment to determine that the gun is properly zeroed for deflection. In order to insure traverse

and search of the entire target with handwheels, center the traversing gear housing and expose  $\frac{1}{2}$  inch of the elevating screw threads, loosen the traversing clamp and cradle handle, adjust the gun so that the line of aim is on figure 8 on the target, and then tighten the traversing clamp and cradle clamping handle.

(3) Upon receiving the fire order given by the squad instructor, the pupil repeats the command, insures that there is sufficient space on the traversing and elevating screws to make the designated manipulation, sets the sight, lays the gun on the designated paster, takes the correct gunner's position, and reports, "Up."

(4) At the command COMMENCE FIRING, given by the squad instructor, the pupil repeats the command, simulates firing a burst; either traverses the gun, elevates it, or traverses and elevates it in accordance with the fire order, and simulates firing a second burst. He continues the exercise, frequently checking his laying on the aiming line. Before firing the final burst, the pupil will check his laying on the aiming paster which terminates the exercise.

*c.* While the pupil is performing these operations, the squad instructor—

(1) Checks the sight setting and the initial laying.

(2) Checks the pupil's position, particularly the grip.

(3) Sees that the proper manipulation is made after each simulated burst.

(4) Sees that the pupil frequently looks through his sights and checks his laying.

(5) Sees that the pupil simulates the firing of a burst before manipulating the gun.

(6) Sees that the proper number of manipulations is used.

(7) At the completion of the exercise, checks the aim and discusses with the pupil any errors made by him during the exercise.

*d.* Instruction in traversing exercises is taken up first, searching exercises second, and, finally, combined traversing and searching exercises. Instruction in each phase is continued until each man becomes proficient in that particular phase.

*c.* TRAVERSING EXERCISE (fig. 88). The instructor makes the following explanation:

(1) The lateral distance between pasters Nos. 1 and 2 is 14 inches; between Nos. 2 and 3, 16 inches; and between Nos. 3 and 4, 14 inches.

(2) For example, to engage a target extending from paster No. 2 to paster No. 3, it is necessary to perform eight 2-mil traverses to distribute the fire uniformly over the target.

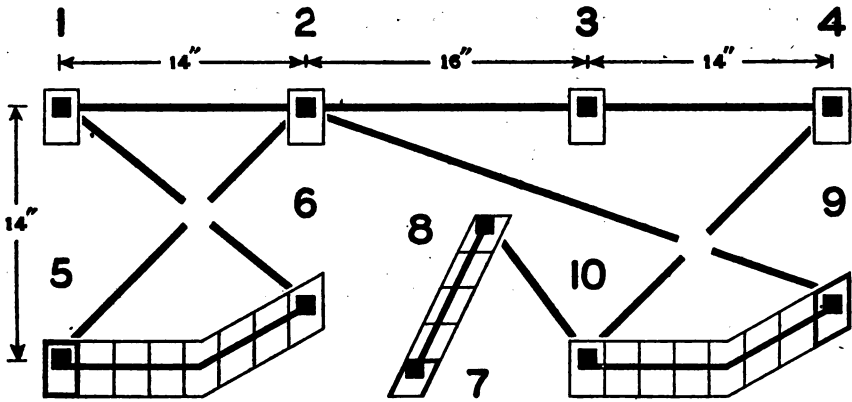


Figure 88. 1,000-inch machine gun manipulation target.

(3) The fire order to be given in this exercise would be, for example: 1. RANGE SEVEN HUNDRED, 2. PASTER NO. 2, 3. TRAVERSE RIGHT ONE SIX. The instruction then proceeds as described in *b* above.

*f.* SEARCHING EXERCISE (fig. 88). The instructor makes the following explanation:

(1) The vertical distance between pasters Nos. 5 and 1, and 10 and 3 is 14 inches.

(2) For example, to engage a target from paster No. 5 to paster No. 1, it is necessary to perform seven 2-mil searches to distribute the fire uniformly over the target.

(3) The fire order to be given in this exercise would be, for example: 1. RANGE SEVEN HUNDRED, 2. PASTER NO. 5, 3. SEARCH UP ONE FOUR. The instruction then proceeds as described in *b* above.

*g.* COMBINED TRAVERSING AND SEARCHING EXERCISE (fig. 88). The instructor makes the following explanation:

(1) In this exercise the pupil manipulates the gun so as to cover a target which extends obliquely from the gun, such as that represented by the lines connecting paster Nos. 7 and 8, 5 and 2, or 10 and 4.

(2) To cover such a target, the pupil varies the amount of traverse and search to suit the slope of the target. For example, the target represented by the line connecting pasters Nos. 7 and 8, requires a traverse of 1 mil, and a search of 2 mils after each simulated burst. The targets represented by the lines connecting pasters Nos. 5 and 2, and 10 and 4, require a traverse of 2 mils and a search of 2 mils after each simulated burst. Targets requiring a nonuniform amount of traverse and search are represented by the lines connecting pasters Nos. 6 and 1, 9 and 2, and 10 and 8.

(3) The fire order given would be, for example: 1. RANGE NINE HUNDRED, 2. PASTER NO. 5 TO PASTER NO. 2, 3. TRAVERSE AND SEARCH. The instruction then proceeds as described in *b* above.

*h.* Men equipped with the M1919A6 gun should become proficient with the gun mounted on the M2 tripod before they have practical work with the gun mounted on the bipod.

### 106. Training in Range Estimation by Eye

*a.* All personnel should be trained to estimate distance with a fair degree of accuracy.

*b.* NECESSITY FOR TRAINING. Estimates of range made by untrained men are little better than guesses, and their average errors will be at least 12 percent of the range. A definite system of range estimation, frequently practiced, is the only way to make estimation by eye reliable.

*c.* METHOD OF ESTIMATION BY EYE. (1) Estimation by eye consists of measuring the range by applying to it a unit of measure 100 yards long. The method is the same as that employed in measuring the length of a board with a ruler. The only difference is that the soldier's unit of measure is applied mentally. Familiarity with the 100-yard unit and its appearance on different kinds of ground and at different distances will enable the estimator to apply it with a fair degree of accuracy.

(2) Application of the unit of measure beyond 500 yards is difficult. For this reason, in ranges over 500 yards, it is better to select a point halfway to the target, apply the 100-yard unit up to that point, and multiply the estimated distance by two.

*d.* AN ALTERNATE METHOD OF ESTIMATION. Another satisfactory method of estimating ranges is to memorize, through frequent practice, the appearance of objects, vegetation, etc., and the amount of detail that can be distinguished at a few key ranges, and then to interpolate between these ranges to determine the desired distance. By learning the appearance of a man at 300, 500, 700, and 1,000 yards and memorizing the details that can be distinguished on the man at those key ranges, a reliable range estimation can be made if an individual is the target or is in the vicinity of the target.

*e.* CONDITIONS AFFECTING APPEARANCE OF OBJECTS. (1) Conditions of light and terrain have considerable effect upon the appearance of objects, sometimes making them seem much nearer and at other times much more distant than they really are. The effect of these conditions on the appearance of the 100-yard unit of measure is negligible.

(2) In some cases, much of the ground between the observer and the target will be hidden from view and the application of the unit of

measure to the hidden portion of the ground will be impossible. In such cases, the appearance of objects is the only guide.

(3) Whenever the appearance of objects is used as a basis for range estimation, the observer must make allowance for the effects noted below:

(a) Objects seem nearer—

1. When the object is in a bright light.
2. When the color of the object contrasts sharply with the color of the background.
3. When looking over water, snow, or a uniform surface, like a wheat field.
4. When looking from a height downward.
5. In the clear atmosphere of high altitudes.
6. When looking over a depression most of which is hidden.

(b) Objects seem more distant—

1. When looking over a depression all of which is visible.
2. When there is a poor light or fog.
3. When only a small part of the object can be seen.
4. When looking from low ground toward higher ground.

f. EXERCISES. For exercises recommended for training students in range estimation by eye, see FM 23-5.

### 107. Observation and Adjustment of Fire

a. The purpose of observation and adjustment practice is to teach the soldier the adjustment of fire by the observation of strike and by the observation of the flight of tracer bullets.

b. Preparatory instruction consists of instruction in the nature of the cone of fire and the manipulation required to move the center of impact of the beaten zone at key ranges.

c. The instructor will first explain the essential characteristics of the cone of fire and the beaten zone at the key ranges (pars. 162 and 163), using a sand table, charts, or actual firing on the ground for the purpose. He will then explain and, if practicable, have a gunner demonstrate by firing tracer ammunition, the manipulation required to move the center of impact of the beaten zone at the key ranges. He will base this latter explanation and demonstration on the following rule of thumb which is based on conditions where the gun and target are on level ground.

(1) A 1-mil change of *direction* (right or left) will change the beaten zone as follows:

- $\frac{1}{2}$  yard at a range of 500 yards.
- 1 yard at a range of 1,000 yards.
- $1\frac{1}{2}$  yards at a range of 1,500 yards.

(2) A 1-mil change of *elevation* (up or down) will vary the center of impact approximately as follows:

Ranges in yards	Ball ammunition, M2	AP ammunition, M2
Up to 600.....	100 yards to 63 yards.....	100 yards to 62 yards
From 600 to 1,000.....	65 to 34 yards.....	62 to 32 yards
From 1,000 to 1,500.....	34 to 19 yards.....	32 to 19 yards

*Note.* For firing tables, see appendix V. When belts are loaded with a major proportion of AP ammunition, tables in paragraph 12, appendix V, will be used.

(3) To shift the center of impact approximately 100 yards requires the following change in *elevation*:

Ranges in yards	Ball ammunition, M2	AP ammunition, M2
From 100 to 600.....	1 mil .....	1 mil
From 600 to 1,000.....	2 to 3 mils .....	2 to 3 mils
From 1,000 to 1,500.....	3 to 5 mils .....	3 to 5 mils

*d.* After explaining and demonstrating this rule of thumb, the instructor gives exercises in theoretical adjustments based on it, either upon a sand table, a chart, or the ground.

*e.* As soon as the men understand and can apply the rule of thumb for conditions where the gun and target are on level ground, the instructor will explain and demonstrate modifications in the rule to be applied when the ground slopes in the vicinity of the target. The effect of slope upon the unit value of a 1-mil change in elevation can be demonstrated upon a sand table, upon any other short-range method of representing relief, or upon the ground.

### 108. Windage Corrections

*a.* The amount by which the wind deflects the cone of fire from its normal path depends upon the force and direction of the wind and the range to the target. The amount of windage required to correct for a 3 o'clock or 9 o'clock wind (considering 12 o'clock to be the direction of the target) having a velocity of 10 miles an hour, when using caliber .30, M2 ball and M2 armor-piercing ammunition, is shown in the following table:

Key range (yards)	Corrections (mils)	
	M2 ball	M2 armor-piercing
500.....	1	2
1,000.....	4	4
1,500.....	7	7
2,000.....	10	10

*b.* The effect of winds of other velocities or at other ranges can be approximated by using this table. For practical purposes, the effect of wind varies directly as its force. For example, a 20-mile wind would

require twice the correction required for a 10-mile wind. Considering 12 o'clock to be the direction of the target, winds that are 1 hour from 3 o'clock or 9 o'clock (2, 4, 8, or 10 o'clock) require slightly less windage correction than 3 o'clock or 9 o'clock winds. Winds that are 1 hour from 6 o'clock or 12 o'clock (1, 5, 7, or 11 o'clock) require slightly less than one-half as much windage correction as 3 o'clock or 9 o'clock winds.

c. Windage correction tables for M2 ball ammunition are provided in paragraph 2, table VIII, appendix V, and for M2 armor-piercing ammunition in paragraph 4, table VIII, appendix V.

### 109. Preliminary Gunner's Test

a. Preliminary gunner's tests are held from time to time at the discretion of organization commanders, subject to instructions issued by higher authority. Organization commanders prescribe methods of procedure, and issue orders announcing satisfactory completion of preliminary gunner's tests, with the scores attained. Higher commanders exercise such supervision as will insure the maintenance of a proper standard in the conduct of these tests.

b. The test includes 16 subjects, each of which is graded on a basis of 6 or 7 points as shown below; the total possible score is 100. A total score of 80 is required for satisfactory completion of the test.

c. The test is as follows:

	<i>Score</i>
(1) Remove groups to the extent required for ordinary cleaning and minor repairs in the field . . . . .	6
(2) Disassemble and assemble the bolt . . . . .	6
(3) Disassemble and assemble the cover . . . . .	6
(4) Disassemble and assemble the lock frame . . . . .	6
(5) Disassemble and assemble the barrel extension . . . . .	6
(6) Assemble the machine gun . . . . .	6
(7) Demonstrate and explain the making of correct head space adjustment . . . . .	6
(8) Demonstrate the application of immediate action . . . . .	7
(9) Explain why the gun will not fire with the cover unlatched . . . . .	7
(10) Explain why the belt is pulled and jerked in the second phase of immediate action . . . . .	7
(11) Explain why the first round in the belt is removed as part of the second phase in immediate action . . . . .	7
(12) Demonstrate and explain how to use the ruptured cartridge extractor . . . . .	6
(13) Demonstrate the points to be observed before firing . . . . .	6
(14) Clean and oil the bore as it should be done after firing. (Assume no metal fouling is present) . . . . .	6



- (15) Explain the care and cleaning of the remainder of the gun. . . 6
- (16) Inspect a loaded belt and make any corrections necessary to prepare it for firing. (Belt to have at least one each of the following: short round, deformed round, loose bullet, round pushed too far into belt loop, round not pushed far enough into the belt loop, empty loop.) . . . . . 6

### Section III. RANGE PRACTICE

#### 110. Purpose

a. The purpose of range practice is to teach the soldier to apply the fundamentals of machine gun marksmanship as prescribed in paragraph 94. The method of instruction is prescribed in paragraph 96.

b. Instruction practice teaches the accurate delivery of fire, mechanical skill in manipulating the gun to cover all classes of targets, and observation and adjustment of fire. Time limits prescribed in the tables are optional for instruction practice.

c. Record practice is the final test of the gunner's efficiency in all phases of instruction in machine gun marksmanship and furnishes the means for classifying him according to the proficiency he has attained.

#### 111. Marksmanship Courses

a. GENERAL. Course A is prescribed in tables I and II, and course B in tables III and IV.

b. COURSE A. Instruction practice consists of firing tables I and II at least once. Record practice consists of firing tables I and II once. The instruction and record practice prescribed in table I may be completed prior to commencing instruction and record practice in table II. With the M1919A6 machine gun, table I is fired from the tripod, and table II from the bipod.

Table I<sup>1</sup>

Range (inches)	Time (seconds)	Total shots	Target	Type of fire
1,000	40 <sup>2</sup>	48	1,000-inch heavy machine-gun target. (Pasters 5 to 6 or 9 to 10.)	Combined, one exercise, 48 rounds. One burst each scoring space.
1,000	30 <sup>3</sup>	30	1,000-inch heavy machine-gun target. (Pasters 7 to 8 or 8 to 7.)	Searching, one exercise 30 rounds. One burst each scoring space.

<sup>1</sup>Prior to firing this table for instruction and record practice, the firer will be permitted one adjustment burst of six rounds at one of the fixed scoring spaces. These will be no time limit for adjustment firing and the burst will not be scored. In firing this table, the soldier must not know which type of exercise he will fire until he takes his position at the gun. The officer in charge will inform the individual of the exercises to be fired. The searching exercise will be fired in the lateral direction opposite to that in which the combined traversing and searching exercise is fired.

<sup>2</sup>Forty-five seconds for light machine guns.

<sup>3</sup>Thirty-five seconds for light machine guns.

Table II

Range (yards)	Time	Total shots	Target	Type of fire
400 to 800	4 min	120	8 double "E" silhouette targets.	Fixed. 1 exercise, 120 rounds.

c. COURSE B. With all guns on the tripod mount, instruction practice consists of firing tables III and IV once. Record practice consists of firing table IV once. Following record practice with the tripod, the M1919A6 machine gun is fired from the bipod for familiarization.

Table III

Range (inches)	Time (seconds)	Total shots	Target	Type of fire
1,000 .....	No limit .....	12	1,000-inch machine-gun target.	Zeroing allowance per man during instruction practice.
1,000 .....	No limit .....	24	1,000-inch machine-gun target.	FIXED (4 exercises, 6 rounds each).
1,000 .....	No limit .....	30	1,000-inch machine-gun target.	SEARCHING (1 exercise, 30 rounds).
1,000 .....	No limit .....	96	1,000-inch machine-gun target.	COMBINED (2 exercises, 48 rounds each).
1,000 .....	No limit .....	150	1,000-inch machine-gun target.	FIXED, SEARCHING, and COMBINED. (7 separate exercises, 150 rounds).

Table IV

Range (inches)	Time (seconds)	Total shots	Target	Type of fire
1,000 .....	No limit .....	12	1,000-inch machine-gun target.	Zeroing allowance per man during record practice.
1,000 .....	12 (each exercise).	24	1,000-inch machine-gun target. (Pasters 1, 2, 3 and 4.)	FIXED, 4 separate exercises, 6 rounds each. One burst each scoring space.
1,000 .....	30	30	1,000-inch machine-gun target. (Pasters 7 to 8.)	SEARCHING, 1 exercise, 30 rounds. One burst each scoring space.
1,000 .....	40 (each exercise).	96	1,000-inch machine-gun target. (Pasters 5 to 6 and 9 to 10.)	COMBINED, 2 exercises, 48 rounds each. One burst each scoring space.

## Section IV. CONDUCT OF RANGE PRACTICE

### 112. Officer in Charge of Firing

The officer in charge of firing is responsible for the efficient conduct of range practice. This officer is detailed by the regimental or other commander of the troops being trained. His principal duties are as follows:

- a.* To arrange, coordinate, and supervise the assignment of firing points.
- b.* To insure the application of safety precautions by all units firing. (See AR 750-10.)
- c.* To make decisions upon interpretation of the rules governing record practice which may be referred to him.
- d.* To make all decisions relative to action on stoppages.

### 113. Range Officer

Operation of the range is the responsibility of the range officer. He should be appointed well in advance of range practice. The principal duties of the range officer are—

- a.* To make timely estimates for material and labor in order to place the range in proper condition for firing.
- b.* To supervise and direct repairs to installations.
- c.* To regulate the distribution of ranges and targets.
- d.* To maintain a supply of the materials required.
- e.* To instruct and supervise range guards.
- f.* To assist the officer in charge of firing in enforcing safety regulations.

### 114. Uniform and Equipment

*a.* The uniform and individual equipment to be worn during range practice will be prescribed by the regimental or other commander of the units to be trained.

*b.* Each squad should be equipped with at least one machine gun and tripod mount, complete, prepared for firing. If available, two machine guns and tripod mounts, complete, similarly mounted and prepared for firing, will facilitate the conduct of the exercises.

### 115. Zeroing Gun

*a.* GENERAL. Before any barrel is used in firing, it is zeroed with the gun in which it is to be used. The zeroing process is for the purpose of determining, and correcting for, the mechanical error of the gun and barrel.

*b. WHEN TO ZERO GUN.* (1) A gun may be rezeroed at any time during instruction practice. During record practice, the officer in charge of firing decides when rezeroing is needed. He may authorize it after an exercise has begun, and before it is completed, if he decides reduction of a stoppage has made rezeroing necessary. In the latter case, the gun will not be rezeroed on the exercise being fired.

(2) The same gun will usually have a different zero for each barrel used. Once a gun and barrel have been zeroed, it will not ordinarily be necessary to repeat the operation during the life of the barrel. However, the head space adjustment must be correct, and the packing of the M1917A1 gun must be done properly, in order that the zero may not be changed. For example, it has been found possible to vary the position of the shot group on a target as much as 4 mils by wide changes in head space adjustment alone. Minor repairs to the gun may not affect the zero, but major repairs, such as replacing the barrel extension or the sight or cover, will necessitate rezeroing.

*c.* An allowance of 12 rounds per man is allotted for zeroing the gun during instruction and record practice. In addition, any part of the allowance for instruction and record practice which may be saved can be used for zeroing purposes.

*d. CHECKS TO BE MADE BEFORE ZEROING MACHINE GUN.* Before zeroing, checks should be made to see that—

(1) *All three guns—*

(a) The bore is clear.

(b) The head space adjustment is correct.

(c) The pintle bolt is reasonably tight.

(d) The tripod is properly mounted.

(2) *M1917A1 gun—*

(a) The muzzle gland is correctly adjusted.

(b) The water plugs are tight.

(c) Water is in the water jacket.

(d) The pintle and pintle housing are clean and lightly oiled.

(e) The dial is level.

(f) All clamps are tight.

(3) *M1919A4 and M1919A6 guns.* (a) The front barrel bearing plug of the M1919A4 gun is screwed in tight. The booster cap and lock ring of the M1919A6 gun are tight.

(b) The locking screw and the bracket screw of the front sight are tight.

*Note.* To prevent the front sight screws from loosening and allowing the front sight to slip, remove the bracket screw. Place a split washer in the recess for the bracket screw and tighten the screw.

(c) The elevating pin is reasonably tight.

(d) The trail spades and the front leg spade are pounded well into the ground, care being taken that none of the spades rest upon stones or any other hard surface.

(e) The traversing slide clamp is tight.

(f) The shoulder stock wing nut of the M1919A6 gun is tight.

(g) The ends of the bipod leg tubes of the M1919A6 gun are seated in the recesses provided in the bipod head and the upper and lower thumb screws are tight.

*e. PROCEDURE FOR ZEROING ALL GUNS.* (1) Set the rear sight at the zeroing graduation (441 yards for the heavy gun and 400 yards for the light guns), with the windage gauge at zero, and fire a burst of six rounds at an aiming paster on a 1,000-inch machine gun target placed 1,000 inches from the gun pintle.

(2) Clear the gun, being careful not to alter the lay.

(3) Determine by inspection the center of the shot group.

(4) If the center of the shot group is at the middle point of the lower edge of the aiming paster, the gun is properly zeroed. Otherwise, mark the center of the shot group with another aiming paster, the bottom of which is centered in the shot group.

(5) Lower the cover on the M1917A1 gun and manipulate the rear sight (without moving the gun) in both elevation and deflection until the line of aim is on the center of the shot group. Lower the sight leaf, loosen the screws holding the adjusting plate, and place the tips of both adjusting plate blades exactly on the zeroing graduation. Then tighten the screws, making sure that the tips of both blades are still set on 441, the zeroing graduation.

(6) Lower the cover on the M1919A4 and M1919A6 guns and see that the gun is still laid on the original paster, and if not, relay on that paster. Then, without further moving the gun, direct the assistant to loosen the screws on the front sight and, as directed by the gunner, manipulate the front sight body in elevation and the blade in deflection until the line of sight is on the middle point of the lower edge of the new aiming paster. The assistant then tightens the screws.

(7) Lay the gun on another aiming paster and fire a confirming burst. The center of impact should be exactly at the point of aim.

(8) Note and record the deflection zero.

*f.* (1) A gun may zeroed or rezeroed by adjusting the sights on any discernible burst (provided the lay of the gun has not been changed), aligning the sights upon the center of the burst, and then proceeding as described in *e* above.

(2) In combat or on maneuvers, if the requirements of safety or secrecy preclude zeroing by firing, it may be zeroed by "bore sighting." With the backplate and bolt removed, align any suitable aiming mark at 1,000 inches on the line of aim at the center of the two concentric circles formed by the rear and front ends of the barrel. Using this aiming mark as the center of impact, zero the gun as described in *e* above, omitting the confirming burst in *e*(7).

### 116. Conduct of Exercises

*a.* All firing will be initiated by fire orders of the type given in the description of the exercises in paragraph 117. The gunner (pupil) will repeat all fire orders.

*b.* The trail shoe of the M1917A1 tripod may be floated as described in paragraph 86. The use of a wooden or concrete T-base or other base is prohibited.

*c.* The use of a T-base or other devices for steadying the M2 tripod is prohibited.

*d.* The sight leaf will be kept raised during all firing. Both sights of the machine gun should be blackened to overcome glare. This is done by holding each sight for a few seconds in the point of a small flame which will produce a smooth, uniform coating of lampblack on the metal. Among the most commonly used flames are those produced by a candle, a piece of camphor, shoe paste, a rag saturated with oil, a carbide lamp, or a wick in a can of oil.

*e.* Before firing, the gunner will examine all the equipment outlined in paragraph 47, 56, or 64. He will be required to make this inspection as a matter of training.

*f.* During instruction practice, the squad instructor (as coach), the gunner, and an assistant gunner, are allowed at the gun. The instructor or any assistant instructor may be at the gun when his presence is needed.

*g.* The success of the instruction during instruction practice will depend to a great extent upon the thoroughness and exactness with which the squad instructor performs his duties. These duties are—

(1) To require the gunner to inspect and prepare his gun and equipment. (See par. 105*b*.)

(2) To require the gunner to explain the practice he is about to perform.

(3) To require the gunner to check the traversing and elevating mechanism to insure that he has sufficient space on the screws for the total amount of manipulation required, and, after laying the gun to insure that the clamps are tight.

(4) To check the sight setting and laying, requiring that they be correct, and to lay the gun off in deflection not less than 5 nor more than 10 mils.

(5) To observe the gunner's position, grip, and manipulation during firing. He may stop the firing, if necessary, to correct errors.

(6) To require the gunner to fire bursts as required for each target.

(7) To require the gunner to adjust his fire by observation when observation of shot groups is possible.

(8) To require the gunner to adjust his fire by frequently looking through the sights, when observation of shot groups is impossible.

(9) To point out errors and explain their effect upon the exercise.

(10) To keep constant watch upon the adjustment and condition of the gun.

#### 117. Instruction Practice for Tables I, III, and IV

a. PURPOSE. The purpose of instruction practice for tables I, III, and IV is—

(1) *For fixed fire.* To teach skill in the correct method of delivering the initial burst of fire, and to familiarize the gunner with a six-round burst.

(2) *For searching fire.* To teach the proper distribution of fire over a deep target.

(3) *For combined traversing and searching fire.* To teach the proper distribution of fire over a target requiring both traversing and combined traversing and searching fire.

b. DEMONSTRATION OF PRACTICE. (1) To demonstrate each of the exercises, the instructor uses a demonstration group of four men. One man takes position at the gun as gunner, one man to the right of the gun as squad instructor, one man to the left of the gun as assistant gunner, and one man in rear of the gun as observer. The equipment required is one machine gun, ammunition for the exercises, (78 rounds, table I; 312, table III; 150, table IV), and two 1,000-inch machine gun targets. The machine gun, with sights blackened, is properly mounted. One of the targets is set up 1,000 inches from the gun (measured from the gun pintle). The other target is placed where the instructor can point to it.

(2) The procedure in demonstrating each of the exercises is as follows:

(a) The instructor directs the gunner to inspect and prepare the gun and ammunition for the exercise, and then explains the exercise he is about to perform.

(b) For fixed fire, the instructor commands: 1. SPACE SIX, HALF LOAD, 2. RANGE SEVEN HUNDRED, 3. PASTER NO. 1 (2, 3, 4), 4. FIXED. For searching fire, the instructor commands: 1. SPACE THREE ZERO, HALF LOAD, 2. RANGE SEVEN HUNDRED, 3. PASTER NO. 7 (8), 4. TRAVERSE AND SEARCH. For combined traversing and searching fire, the instructor commands: 1. SPACE FOUR EIGHT, HALF LOAD, 2. RANGE SEVEN HUNDRED, 3. PASTER NO. 5 (9), 4. TRAVERSE AND SEARCH.

(c) The gunner repeats the command, half loads, sets the sight, lays on the designated paster, takes the correct gunner's position, and reports, "Up."

(d) The squad instructor checks these operations, particularly the position, the grip, the sight setting, and the laying, requiring that they be correct. He then lays the gun off as prescribed in paragraph 116g(4).

(e) The instructor then commands: 1. RANGE FOUR FOUR ONE (FOUR HUNDRED), 2. SIX ROUND BURST(S), 3. COMMENCE FIRING.

(f) The gunner repeats the command, and after the last word of the command given by the instructor, fully loads, resets the sight, relays the gun, takes the correct gunner's position, and fires the exercise. At preparatory command COMMENCE, the gunner may put his right hand forward and over, but not touching, the bolt handle.

(g) Prior to the firing, the squad instructor checks the actions of the gunner and the sight setting and laying, requiring the immediate correction of any errors he finds. He then directs the gunner to fire. During the firing, he notes any errors in position, grip, adjustment, and manipulation; and, if necessary, stops the firing to correct errors.

(h) After firing the exercise, the gunner checks the aim on the terminal paster.

(i) The squad instructor also checks the aim, points out any errors made by the gunner, and explains their effect upon the exercise.

(j) The squad instructor and gunner then examine the shot group(s). The instructor points out any errors in size and location, showing how to correct them, and explaining that an effective shot group must be contained within a scoring space. He further explains that, when a gun is mounted and adjusted properly, a large dispersion of the shot group(s) indicates improper gripping; that errors in location of the group may



be due to a poorly mounted or adjusted gun, incorrect sight setting, incorrect laying, or improper grip.

c. **EXPLANATION OF EXERCISE.** (1) For fixed fire, the instructor explains that the four upper scoring spaces represent targets which require fixed fire and the application of the principle of accurate delivery of the initial burst. Each exercise is fired separately, preferably in one sitting, each consisting of a single burst of six rounds which should strike in the 2-inch by 3-inch scoring space. In table I, the gunner fires only one fixed fire exercise.

(2) For searching fire, the instructor explains that the scoring group represents a deep target, such as a column of troops or a communication trench, and requires the application of the fundamentals prescribed in paragraph 94a(1), (2), (3)(a), and (3)(c). The exercise consists of firing five bursts of six rounds each on scoring groups 7 to 8 (8 to 7). The group is slightly inclined, and consists of five 2-inch by 2-inch scoring spaces, the initial scoring space being visible to the gunner. If the first burst is seen to strike within the initial scoring space, the gunner traverses right (left) 1 mil and searches up (down) 2 mils, and fires another burst. If any burst does not strike in a scoring space, fire is adjusted (par. 116g(7) or (8)) and the next burst fired at the missed scoring space. The remaining ammunition must then be distributed over the remaining scoring spaces. Inasmuch as one of the objects of the exercise is the proper distribution of shots over the entire scoring group in one application of fire, the gunner will cease firing, after he has fired on the last scoring space (without retracing), although he may not have exhausted his ammunition allowance. The ammunition thus saved may be used for zeroing purposes. (See par. 115.)

(3) Combined traversing and searching fire is used when firing on scoring group 5 to 6, or on scoring group 9 to 10. On that part of the scoring group which requires a combined traverse and search, the slope is *one on two* ( $30^\circ$ ) which requires a 2-mil traverse and a 1-mil search. Scoring spaces are 2 inches by 3 inches. If any burst does not strike in a scoring space, fire is adjusted (par. 116g(7) or (8)) and the next burst fired at the missed scoring space. The remaining ammunition must then be distributed over the remaining scoring spaces. On scoring group 5 to 6, the gunner fires the second burst, and continues the process until he has fired five bursts. He then traverses right 2 mils and searches up 1 mil, fires the sixth burst and continues the process until he reaches paster No. 6. Scoring group 9 to 10 is the reverse of scoring group 5 to 6.

d. As soon as each man has fired one or more exercises with the squad instructor, the coach-and-pupil method may be used.

e. If time is available, the gunner should be required to "dry run" the exercise a number of times prior to the firing prescribed above.

### 118. Instruction Practice for Table II

a. **PURPOSE.** The purpose of instruction firing is to teach the soldier to search for and locate targets quickly and accurately, estimate the range, and engage targets, adjusting his fire if necessary.

b. **DEMONSTRATION OF PRACTICE.** (1) To demonstrate the firing, the instructor uses a demonstration group of four men. One man, acting as the gunner, with the tripod mount or the M1919A6 gun, lies in a prone position 5 yards in rear of the firing point. The tripod legs will be folded. However, the bipod leg tube extensions may be properly adjusted for height, and the legs unfolded. Nos. 2 and 3, equipped as prescribed in paragraph 46, 55, or 63, lie in a prone position in rear of the gunner. The fourth man acts as the squad leader and takes a position near the firing point from which he can observe the gunner and the range. The equipment required is a machine gun, ammunition for the exercise, and one double "E" target. The sights of the gun should be blackened. The one double "E" target is placed where the instructor can point to it.

(2) The procedure in demonstrating the firing is as follows:

(a) The instructor directs the gunner to examine all the equipment prior to firing as prescribed in paragraph 47, 56, or 64. The instructor then explains the exercise that the gunner is going to fire.

(b) The instructor explains that eight double "E" targets are located in a lane not more than 75 yards wide and 800 yards deep. The nearest target is located approximately 400 yards from the firing point, and the farthest approximately 800 yards. Intermediate targets are spaced irregularly in width and depth. Each target consists of two "E" silhouette targets fastened abreast without interval. The targets are fastened to a stick with a flag at its top and are operated by men protected in individual pits. Targets are exposed individually on signal from the officer in charge of firing. Either side may be exposed. Targets are withdrawn when hit or when two bursts have been fired at that target. Ricochets count as hits.

(c) When the first target appears, the squad leader will indicate the target and the firing point and command: ACTION. Target designation should be by pointing, accompanied, if necessary, by a simple verbal description.

*Note.* A typical fire order would be: "GUN TO BE MOUNTED HERE. FRONT. SILHOUETTE. ACTION."

However, at no time will the squad leader announce the range to a target. Time will be taken from the command: ACTION. The crew then will

put the gun into action in the prescribed manner. After going into action, the gunner will estimate the range to the target, set his sights, lay on the target, fire a burst, and observe the strike. If the target is hit, it is withdrawn. If the target is not hit, the gunner, if firing from the tripod, determines from the strike the amount of traverse and search required to place the next burst on the target, and manipulates the gun accordingly; if firing from the bipod, the gunner may either change the elevation and windage on the sights or select an aiming point to place the next burst on the target. He then fires his second burst at the target. The target is withdrawn automatically after the second burst. No marking of targets is required, since a flag is waved after the second burst if the target was again missed; if the flag is not waved, the target has been hit.

(d) As soon as a target is withdrawn, the next target is exposed and indicated to the firer by the squad leader. The remaining targets are engaged in a similar manner to the first target, except that the gun will be mounted or placed in position by each firer for his initial target only. Sights will be set for each new target engaged.

(e) No sequence of raising targets is prescribed, and prearranged sequences will not be used. Different sequences will be used for successive individuals being tested. However, both the nearest target and the farthest will be included in the first four targets to be raised in any sequence. In firing the M1917A1 gun, the first target to be raised should be along the middle line of the lane projected from the gun location, so that when the gun is mounted facing the first target, there will be sufficient space on the traversing screw to reach the remaining targets.

(f) The ammunition box carried by No. 3 (2) will contain one belt, loaded with 120 rounds of ammunition. Tracers may be used if necessary to observe fire, but will not exceed the proportion of one tracer to three ball cartridges.

(3) The squad instructor notes any errors in position, grip, sight setting, range estimation, manipulation, and adjustment. If necessary, he stops the firing to correct errors. After firing the exercise, he explains how the errors committed by the gunner affected the firing.

*Note.* If time is available, each soldier should be required to "dry run" Table II a number of times prior to the firing prescribed above.

### 119. Record Practice for All Tables

a Record practice consists of the firing prescribed in paragraph 111 or 224. Except as hereinafter specifically stated, the rules for instruction practice will apply to record practice as well. Any departure from the

mandatory provisions governing record practice will disqualify a man for classification purposes.

*b.* In record practice, the gunner takes his place at the gun to fire the prescribed exercises with the prescribed amount of ammunition. During this practice, he must perform all of the operations required in firing, such as setting the sight, laying the gun, manipulation, and firing, within the prescribed time limit.

*c.* When additional compensation for arms qualification is not authorized, the presence of a coach near the gun while a soldier is firing or preparing to fire record practice is permitted, with the following exceptions:

(1) The coach will not use any mechanical aids, such as binoculars, to assist the gunner.

(2) The coach will not touch any part of the gunner's body while the gunner is sighting or firing.

*d.* After completing instruction practice, each man will, when firing tables I, II, or IV, fire the exercises in one sitting, and in the order named in the tables.\* Once begun, record practice in any table will be carried through to completion before any other practice is permitted. Ordinarily, a man will be required to fire record practice on a day subsequent to that on which he fired any part of his instruction practice. However, when the time allotted to range practice is very limited, the officer in charge of firing may authorize the firing of both instruction and record practice on the same day. Both types of practice will not be fired simultaneously however, except—

(1) On ranges where firing of each type of practice is conducted on a different part of the range.

(2)\* When firing table II, gun crews may be permitted to "dry run" on a firing point where record practice is being conducted for other crews.

*e.* The machine gun and tripod as issued by the Ordnance Department will be used in all firing. The use of additional clamps or appliances of any kind on the gun or tripod is prohibited. This provision will not be construed to prohibit the use of cloth patches or similar soft material for the elimination of excessive looseness such as between the gun pintle and the gun pintle housing, and between the elevating screw head and the bracket. The use of cloth patches in the buffer mechanism in lieu of the fiber disks provided for that purpose is specifically prohibited. The sights may be blackened. The ammunition used will be that issued

---

\*Not applicable to procedure for firing of guns mounted in combat vehicles.

by the Ordnance Department. It will be examined carefully and defective cartridges eliminated.

*f.* The prescribed aiming point will be used in laying the gun.

*g.* Sighting or ranging-in shots are prohibited except when firing tables I and III.

*h.* After the gunner has taken his place at the gun for an exercise, all shots fired by him will count as a part of that exercise. The total amount of ammunition used in any exercise, including shots fired accidentally, will not exceed the amount authorized for that exercise. Ammunition left over from one exercise due to the expiration of the time allowance is lost, and will not be added to the ammunition allowance of another exercise. It may be used for zeroing purposes.

*i.* A minimum penalty of five points, if firing table I, III, or IV, and one point, if firing table II, will be deducted from the score of any firer who fails to cease firing at the command or signal. An additional point will be deducted for each shot in excess of five fired after CEASE FIRING is given. The assistant to the officer in charge of firing will exact the penalty.

*j.* When a stoppage occurs during record practice, the gunner will pull the bolt handle once to the rear, release it, relay, and attempt to fire.

(1) If the gun fires, the gunner will continue with the exercise. He will be allowed an additional 2 seconds for each stoppage of this type during the firing of any of the exercises.

(2) If the gun fails to fire, the gunner will hold up his hand, call "Time," and, without touching the gun, await further instructions from the assistant to the officer in charge of firing. This officer will note the time at which the signal of the gunner occurs and will determine the remaining time for the exercise by deducting the elapsed time from the allotted time. He will then inspect the gun to determine the cause of the stoppage.

(3) In making this inspection, he will note where the gun is laid and will count the ammunition remaining for the particular exercise being fired. He will then lay the gun off the target upon which it is laid and press the trigger to determine if an actual stoppage exists. If an actual stoppage exists, he will direct the gunner to reduce the stoppage.

(4) He will then report the nature of the stoppage to the officer in charge of firing, who will give instructions as to whether or not the gunner will be permitted to complete the exercise. If the cause of the stoppage was manifestly the fault of the gunner, the exercise will not be completed and the score will stand. If not, he will be permitted to

complete the exercise. To complete the exercise, the gunner will fully load and lay on the target at that part of the exercise that he was firing when the stoppage occurred. At the command, COMMENCE FIRING, given by the assistant to the officer in charge of firing, the gunner will fire the ammunition that remained for the particular exercise, in the time remaining to complete the exercise plus 2 seconds for each stoppage. In no case will any exercise be completely refired. Should a breakage occur, the gun will be rezeroed or replaced before firing is begun to complete the exercise. If, as a result of pulling the bolt handle to the rear when a stoppage occurs, any unfired or damaged rounds are ejected from the gun, the gunner will be allowed to fire the equivalent of these rounds as soon as the exercise is completed, if firing table I or III. To fire the ejected rounds, the gunner will fully load and lay on the target at that part of the exercise that he was firing when the round, or rounds, were ejected. At the command, COMMENCE FIRING, given by the assistant to the officer in charge of firing, the gunner will fire on the basis of 1 second for each ejected round. This allowance of 1 second is in addition to the allowance of 2 seconds for a stoppage. Since the gunner is required to complete each exercise in sequence, under no condition will he be allowed to fire any exercise except the one that he was firing when the stoppage occurred.

*k.* The rules governing the scoring are as follows:

(1) *Tables I, III, and IV.* Two points are scored for each scoring space hit; one point is scored for each hit in a scoring space, but not more than six hits are counted in any one scoring space. Hits touching the boundary line of a scoring space are counted. A hit touching the line between two scoring spaces is counted in only one space, but the space selected is that which gives the greater score to the gunner. The total possible score is 104 points for table I and 200 points for table III or IV.

(2) *Table II.* One point will be scored for each target hit. The total possible score is 8 points. No score is allowed unless all the targets have been engaged within the prescribed time limit.

(3) *Score card.* A score card will be kept for each person firing, on which the date of the firing and all other entries will be recorded in ink or indelible pencil. No erasures will be made on score cards. Alterations may be made only by the organization commander or an officer acting as scorer, and each alteration will be authenticated by the initials of the officer who made it.

(4) In record practice, the target will be scored by an assistant to the officer in charge of firing. This officer will enter the score on the score card and authenticate the entry.

(5) In firing tables I, III, and IV\*, if a man fires on another man's target in any exercise, he will receive a score only for such hits as are on his own target, and will not be allowed to fire the exercise again. The man on whose target he fired in error will be required to fire the exercise again.

**l. QUALIFICATION.**

Rating	Course A			Course B
	Table I		Table II	Tables III and IV
	Heavy	Light		
Expert .....	65	55	7	184-200
1st class gunner.....	65	55	6	178-183
2d class gunner.....	65	55	5	140-177
Unqualified .....	Less than 65 (heavy) 55 (light)		Less than or 5	Less than 140

*Note.* A gunner, to qualify on course A, must fire a minimum of 65 points (heavy) or 55 points (light) for table I and 5 points for table II.

*m.* A sufficient number of officers to supervise record practice in strict accordance with the rules governing this practice will be detailed as assistants to the officer in charge of firing. Officers for this duty should be from companies other than the one firing. A maximum of two guns can be supervised by one officer. He will perform the following duties in person:

(1) See that the gunner has the correct amount of ammunition and that the rounds are properly spaced.

(2) Lay the gun off in deflection not less than 5 and not more than 10 mils as described for the exercises.

(3) If firing tables I, III, and IV, see that the pupil does not touch the sight or alter the laying of the gun until after the command or signal to commence firing is given. If firing table II, see that the gunner, No. 2, and No. 3 remain in the prone position until the command or signal ACTION is given.

(4) See that the gun is not fully loaded until after the command or signal COMMENCE FIRING or ACTION is given.

(5) Be watchful for the occurrence of stoppages, and perform the duties in connection therewith as prescribed in *j* above.

(6) Make the deduction described in *i* above for firing after the command CEASE FIRING is given.

(7) If firing table I, III, or IV, count the total number of shot holes in the target, and for each hole above 78 for table I, or 150 for tables III and IV, deduct three points from the score, except under the circum-

\*Not applicable to procedure for firing guns mounted in combat vehicles.

stances described in *k*(5) above. No deduction should be made for the adjustment burst allowed in tables I and III.

(8) Count and record the score as prescribed in *k* above.

*n.* Rules applying to table II only:

(1) As far as practicable, men will fire record practice on a different lane from the one used for instruction practice.

(2) If the man being tested is not a member of an organized squad, the organization commander will detail competent assistants.

(3) If any two targets are closer together than 5 mils in width (measured from the firing point), they will not be closer than 150 yards in depth. In determining the location of targets, care must be exercised that all targets can be covered by the manipulation of the traversing handwheel of the M1917A1 gun from the firing point. If the targets can be covered by the M1917A1 gun, they can be covered likewise by the M1919A4 and the M1919A6 guns. Any number of lanes may be constructed.

### 120. 1,000-inch Machine Gun Target (fig. 89)

*a.* In all firing on the 1,000-inch range, this target will be used. The target will conform exactly to the specifications set forth in TM 9-855. When regular printed targets are not available, suitable substitutes can be made on large sheets of wrapping paper.

*b.* For use in preparatory exercises, machine gun unit commanders are authorized to construct 1,000-inch machine gun manipulation targets by drawing in additional aiming lines on the 1,000-inch machine gun target as shown in figure 88.

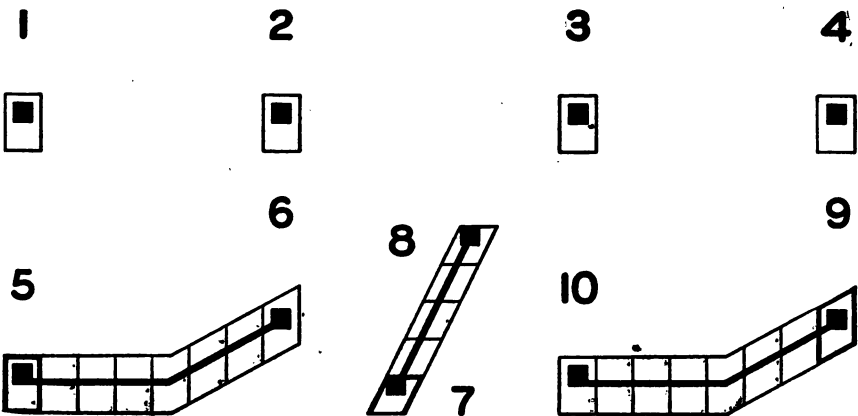


Figure 89. 1,000-inch machine gun target.



## Section V. SAFETY PRECAUTIONS

### 121. General Safety Precautions

General safety precautions necessary for firing caliber .30 machine gun ammunition for training and target practice are contained in AR 750-10.

### 122. Additional Safety Precautions

Additional safety precautions pertaining to personnel at and in the immediate vicinity of the gun are as follows:

a. Firing will not begin on any range until the officer in charge of firing has ascertained that the danger flags are up, necessary guards are posted, and that the range is clear, and has given his authority to fire.

b. No firing will be done except under the direct supervision of an officer.

c. No firing will be done until an officer has ascertained that a cleaning rod and dry patch have been run through the bore of each gun from the muzzle and *immediately removed*.

d. No gun will be loaded or half loaded until a command to do so has been given.

e. After machine guns are fired, and prior to dismounting or removing them from firing positions, each gun will be inspected by an officer to see that it is unloaded. As part of this inspection, a cleaning rod will be passed through the barrel of each gun from the muzzle and *immediately removed*.

f. No one will be allowed in front of the gun for any purpose until directed to do so by an officer. No officer will direct any one to go in front of the gun until he has ordered and has ascertained that all guns have been cleared by having a wooden block, which protrudes a visible height above the gun, inserted in each receiver.

## CHAPTER 4

### MARKSMANSHIP FOR MOVING GROUND TARGETS

---

#### 123. Method of Engaging Rapidly Moving Targets

*a. GENERAL.* The relatively high speed of such rapidly moving targets as scout cars, reconnaissance cars, truck convoys, armored cars, and tanks requires a different technique from that used against moving foot troops. In order to hit a moving target, the bore of a gun must be laid in direction and elevation so that the bullet and the target will reach the same point simultaneously.

*b. FUNDAMENTALS OF PROCEDURE.* To become expert at firing at moving targets, troops must understand that proficiency in the following procedure is necessary, regardless of the type of weapon used:

(1) Accurate delivery of fire with the axis of the bore laid in order to compensate for the range to the target, the speed of the target, and the time of flight of the bullet.

(2) Mechanical skill in manipulating the gun in order to lay the axis of the bore correctly.

(3) Adjustment of fire from observation of strike or tracers.

(4) Maintenance of an adequate volume of fire in order to destroy the target in the shortest possible time.

(5) Rapid shifting of fire to new targets.

*c. TECHNIQUE OF FIRE.* In order to become proficient gunners, men must be trained in—

(1) *Tracer control.* Tracer control is a system of fire control in which the individual gunner places his fire on the target as a result of his own observation of the red tracer stream without the aid of his sights. This method simply requires the coordination of the hand and eye.

(*a*) *Characteristics.* Fire must be continuous in order to provide an unbroken tracer stream. Each tracer that makes up the stream will be at a slightly different range. Also, when the gun is traversed\*, each tracer will be in a slightly different direction. As viewed by the gunner, this series of tracers gives the appearance of a decided curve in the stream.

---

\*Ordinarily, the free gun method of traverse is used. The swinging traverse method may be used when the necessary changes in elevation can be made with the elevating handwheel.

Since each tracer is traveling in a relatively straight line from the gun, this curve is, for all practical purposes, an illusory curve.

(b) *Use of leads in tracer control.* To engage a moving ground target, it is necessary to point the gun ahead of the target to allow the bullet and target to reach the same point simultaneously. The distance ahead of the target at which the gun is pointed is called the lead. (See par. 125.) The necessary lead is determined automatically by the gunner when he uses the red tracer stream for control. The use of the red tracer stream also automatically compensates for the drop in the trajectory caused by gravity.

(2) Continuing the swing, or follow through, while firing.

(3) Maintaining fire on the target until it is obviously disabled or until ordered to shift.

(4) Shifting the fire rapidly to new targets.

d. METHODS OF TRAINING. Training in firing at moving targets should include—

(1) Preparatory training.

(2) Long-range practice.

#### 124. Gunner's Position

a. HEAVY GUN. The position of the gunner for firing at rapidly moving ground targets is the same as that prescribed for firing at stationary ground targets with the exception that the traversing clamp and the cradle clamping handle are loosened.

b. LIGHT GUNS MOUNTED ON TRIPOD. The position of the gunner is the same as prescribed for stationary ground targets with the exception that the elevating mechanism is disengaged from the bar and engaged in the recess in the pistol grip or disengaged from the gun altogether and laid aside.

c. M1919A6 GUN MOUNTED ON BIPOD. Changes in elevation and direction will be made by shifting the position of the shoulders.

#### 125. Leads

In the absence of tracer control, the following method will be employed:

a. GENERAL. The technique of engaging a moving target differs from that of engaging a stationary target in that the axis of the bore must be aimed ahead of the target, along its line of travel, so that the projectile and the target will arrive simultaneously at the same point. The necessary lead is equal to the distance the target will travel between the time the bullet leaves the gun and its arrival at the target, and will vary with the range and with the speed and direction of movement of the target. It is applied in the direction of movement (right or left). As a basis

for all calculations to determine the correct amount of lead to use on targets moving at different speeds, a target-length has been taken as the unit of measure; thus, one lead equals one target-length; two leads equal two target-lengths, etc. To hit a moving target, the gunner lays on the center of the target with the proper lead and maintains his lead by tracking the target, that is, manipulating the gun at the same angular speed as that of the target. When the distance the bullet travels from the gun to the target is so great that there is an appreciable drop in the trajectory, the axis of the bore must be given sufficient elevation to compensate for the drop of the bullet.

*b. DETERMINATION AND APPLICATION OF LEADS.* (1) The lead necessary to hit a moving target depends upon the speed, range, and direction of movement of the target with respect to the line of aim. A vehicle moving at 15 miles an hour will traverse approximately 7 yards in 1 second. A bullet fired at a target at a range of 300 yards will travel that distance in about .4 of a second; at a range of 500 yards, about .7 of a second; at 700 yards, about 1.2 seconds. Therefore, the lead *in yards* required to hit a target 300 yards away, and traveling at 15 miles an hour (7 yards a second), will be .4 times 7, or about 3 yards. Similar computations may be made for the other ranges. Application of leads (target-lengths) makes it unnecessary for the gunner to compute the lead in yards.

(2) The lead table shown below is furnished as a guide and is adaptable for vehicles moving at slower or faster speeds. For example, a vehicle moving at 30 miles an hour at 500 yards would require two leads; a vehicle moving at  $7\frac{1}{2}$  miles an hour at 900 yards would require one lead.

LEAD TABLE

Speed of target in miles per hour	Range to target in yards		
	300	500	900
15	$\frac{1}{2}$ lead	1 lead	2 leads

*Note.* The leads shown in the table above are based on a target approximately 5 yards in length, and  $2\frac{1}{2}$  yards high, and crossing the line of fire at  $90^\circ$ . For targets crossing the line of fire at other angles, proportional adjustments are made. The above table should be used as a guide only.

*c. EFFECTIVE RANGE.* Training in firing at moving ground targets is normally limited to ranges of 900 yards or less.

## 126. Technique of Fire

*a. SIGHT SETTING.* Except for very close ranges, gunners habitually set the sight at 600 yards. All firing is done without changing this sight setting.

*b. APPROACHING OR RECEDING TARGETS.* For ranges of 600 yards or

less, the gunner aims at the lower half of the target; for ranges between 600 and 900 yards, he aims at the upper half. He maintains his aim at the required point and fires a burst. After observing the burst, he elevates or depresses the gun, as required, with the elevating hand-wheel.

*c.* **CROSSING TARGETS.** (1) At ranges of 600 yards or less, the gunner aligns his sights on the bottom half of the target, traverses laterally in the direction the target is moving, and takes the estimated or announced lead based on the lead table in paragraph 125*b*. He traverses and fires simultaneously, maintaining the required lead.

(2) At ranges of more than 600 yards, the gunner proceeds as in (1) above except that he traverses his point of aim across the top half of the target.

*d.* **ADJUSTMENT OF FIRE.** (1) When it is possible to observe the strike of the bullets, or when tracer ammunition is used, the gunner leads and fires his initial burst as described in *b* and *c* above, and immediately raises his head, continuing to track and fire. He observes the strike of the bullets and adjusts his fire while tracking and firing. Long bursts are required.

(2) If cessation of fire is necessary because of a stoppage, disappearance of the target, change of direction of the target, or other cause, the gunner relays on the target at the first opportunity, leads it with the proper number of leads, and fires as described in (1) above.

(3) If there is no observation of strike and tracers are not being used, the gunner does not raise his head to observe, but looks through the sights and directs the line of aim at the target with the estimated or announced lead.

(4) In general, too great a lead is better than too little because the target will run into the fire.

(5) Bursts short of the target are easier to sense than bursts beyond the target.

## **127. Field Firing**

*a.* Guns are placed on the firing line with at least 5 yard intervals. All firing commences and ceases on order of the officer in charge of firing. Fire should be delivered at the maximum rate consistent with accuracy until the command or signal **CEASE FIRING** is given.

*b.* In order to obtain maximum training with the ammunition available, the first few runs of the target should be made with only one gun firing. All other guns simulate firing. After the first few runs, all guns (or such guns as are designated) fire.

*c.* Targets are scored after each run. The results should be posted.

## CHAPTER 5

### MARKSMANSHIP FOR AERIAL TARGETS

---

#### Section I. ANTI-AIRCRAFT GUNNERY

##### 128. Combat Targets

*No aircraft will be fired upon unless it is clearly recognized as hostile or is positively identified as hostile, or attacks with bombs or gun fire. Fire upon hostile aircraft will be opened only upon order of an officer or a responsible noncommissioned officer.* (See FM 100-5.) Low-flying aircraft which come within a slant range of 700 yards or less can be taken under effective fire. Fire is never opened at ranges in excess of 1,000 yards.

##### 129. Antiaircraft Fire

*a. EFFECT.* Machine gun fire is effective against low flying aircraft. Well placed fire destroys or seriously damages the attacking airplane. Also, tracers going into or near an airplane will produce a demoralizing effect upon pilots.

*b. DISTRIBUTION.* The most effective results are obtained by massing the fire of a section or platoon on a single target. When planes are flying in formation, fire should be concentrated on the leading plane. Fire must be shifted to following groups as they approach within effective range.

*c. AMMUNITION LOADINGS FOR ANTI-AIRCRAFT FIRING.* For combat firing, a loading of one tracer to one armor-piercing cartridge is considered best. To observe the tracer stream satisfactorily, the loading should not be below one tracer to four armor-piercing. Loadings of all tracer ammunition may be used for antiaircraft practice firing and for demonstrations.

##### 130. Course of Flight (fig. 90)

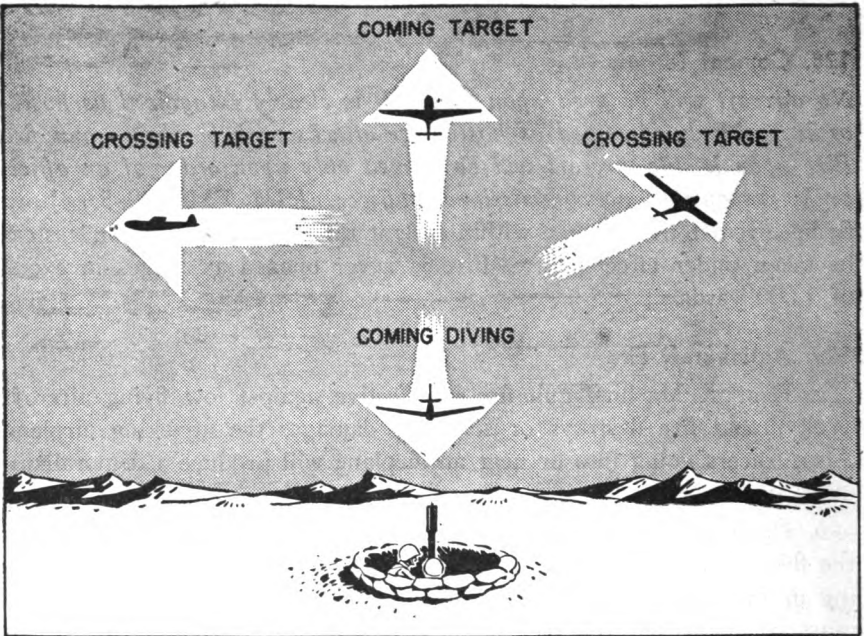
*a.* All targets will fly in one of two distinct types of courses: coming or crossing, either type of which may be level, climbing, or diving.

(1) *Coming targets.* Those targets whose course takes them directly over the gun are coming targets.

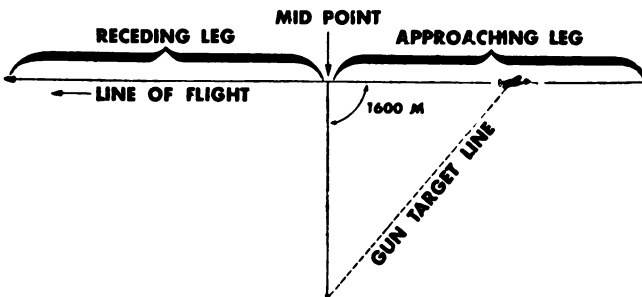
(2) *Crossing targets.* Those targets whose course will not take them directly over the gun are crossing targets.

b. The point along the course of any target at which the target is nearest the gun position is the *midpoint*. That part of the course in which the target is flying toward the midpoint is the *approaching leg*. That part of the course in which the target is flying away from the midpoint is the *receding leg*.

c. An imaginary line from the gun to the target is the *gun-target line*.



①



②

Figure 90. Course of flight.

- d. The line along which the target is flying is the *line of flight*.
- e. The angle between the gun-target line and the line of flight is the *target angle*. The target angle at the midpoint is always 1,600 mils.

### 131. Technique of Fire

a. **LEADS.** For coming courses very little opening lead is necessary. Point the gun at the target or slightly ahead of it and open fire. Since there is very little tracer illusion, fire can be adjusted easily on the target by movement of the tracer stream. For crossing courses lead should be taken so that the estimated lead angle between the gun-target line and the gun barrel axis is approximately 70 mils for each 100 miles per hour target speed.

b. **OPENING FIRE.** After the initial lead is determined, the gunner opens fire with a continuous burst and by observation of the tracers *in the target area* applies the necessary corrections to obtain hits on the target. Due to the large amount of smoke obtained when firing a continuous burst the gunner keeps his head and eyes high above the gun in order to observe his tracers. The dispersion cone of the caliber .30 machine gun is excessive when fired as a free gun. In order to keep the cone as small as possible the gunner grasps the grip firmly with both hands and braces the gun with his body in the best possible manner conforming to his physique and the type of mount from which the gun is being fired.

c. **TRACER STREAM.** Due to the fact that continuous fire is being used while the gun is being traversed quite rapidly, an optical illusion occurs, in which the tracer stream appears to curve quite sharply in a direction opposite to that in which the target is traveling. If the gunner observes the whole of his tracer stream, it becomes confusing and accurate sensings are impossible. Accurate tracer sensings are difficult even under the best conditions. To be able to make accurate tracer sensings the gunner should focus his eyes on the target and sense the tracers in the target area only. For a more complete discussion of tracer observation, see FM 44-51.

d. **CONDUCT OF FIRE.** (1) Having opened fire, the gunner adjusts his fire as follows:

(a) He must first get his shots *on line*. A shot is on line when it intersects the gun-target line. (See fig. 91①.) If a shot is not on line it will be sensed as "low" or "high" on crossing courses, or "right" or "left" on coming courses.

(b) After obtaining line shots the gunner adjusts for lead. This is the most difficult part of the adjustment. Positive sensings are obtained



only if line shots are first established and the gunner observes only those tracers in the immediate vicinity of the target.

(2) Sensings for lead are as follows (fig. 91②):

(a) *Behind* if the tracer is *silhouetted* against the target.

(b) *Ahead* if the tracer is *eclipsed* by the target.

(3) Following are aids in sensing for leads:

(a) If tracers appear to be *behind*, they are *far behind*.

(b) If tracers appear to be *on in lead*, they are still *behind*.

(c) If tracers appear to be slightly ahead, they are probably *not ahead*.

(d) If tracers appear to be *far ahead*, they are probably *on in lead*.

(4) The sequence of action is as follows:

(a) Gunner applies an estimated lead by swinging the gun barrel *far ahead* of the target and along the target's course.

(b) Gunner opens fire and observes tracers in the vicinity of the target.

(c) Gunner corrects shooting until line shots are obtained.

(d) Gunner corrects lead from direct observation if angle of approach is small, or from observation of silhouette or eclipse if angle of approach is large. In case of doubt, he increases his lead.

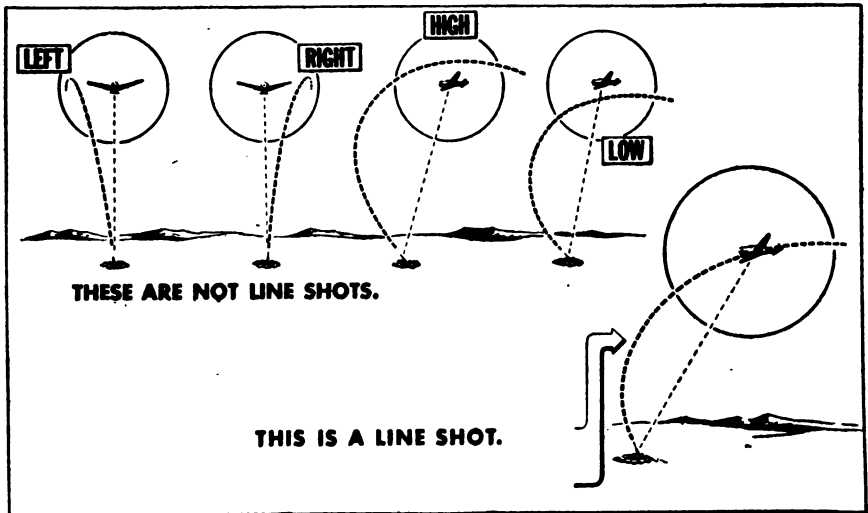


Figure 91①. Example of sensing for line.

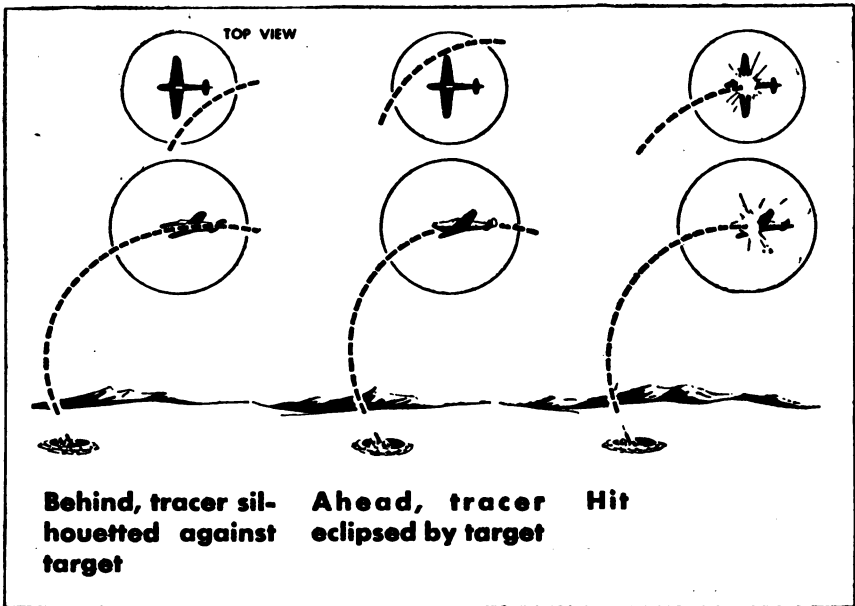


Figure 91(2). Example of sensing for proper lead, after a line shot has been obtained.

## Section II. PRELIMINARY TRAINING

### 132. Scope

*a.* REQUIRED STEPS IN PRELIMINARY TRAINING. Preliminary training consists of the following steps:

- (1) Range and speed estimation.
- (2) Position exercises.
- (3) Tracking exercises.
- (4) Antiaircraft machine gun trainer, M9.
- (5) Demonstration firing.
- (6) Firing exercises.

*b.* Every man will complete the preliminary training prescribed in *a* above, before proceeding to towed and radio-controlled-plane target firing. When it is impracticable to include towed or radio-controlled airplane target firing in an organization's training, long-range practice against fast-moving ground targets, as described in chapter 4, may be substituted. In cases where an organization cannot include either type of firing, it will cover the preliminary training prescribed in *a* above. Such cases are to be regarded as unusual.

c. Instruction in marksmanship as laid down in chapter 3, and long range observation and adjustment practice, should be completed before taking up any part of marksmanship for aerial targets. It is desirable that the training prescribed in chapter 4 also be completed prior to antiaircraft firing.

### 133. Range and Speed Estimation

a. The purpose of range estimation is to train the gunner to estimate the range to hostile airplanes.

b. Training in estimating ranges to airplanes, whenever possible, will consist of having an airplane fly at known key ranges until all are familiar with its appearance. The following table will be found useful:

Range (yards)	Details seen (fig. 92)
200.....	Symbols and numbers. Letters on the plane can be seen <i>plainly</i> .
500.....	Small projections from the fuselage, such as guns and aerials.
700.....	Rudder and cockpit.
1,000.....	General outline of the plane (opening range).
Over 1,000.....	General shape gradually disappears and becomes an elongated speck in the air (out of range).

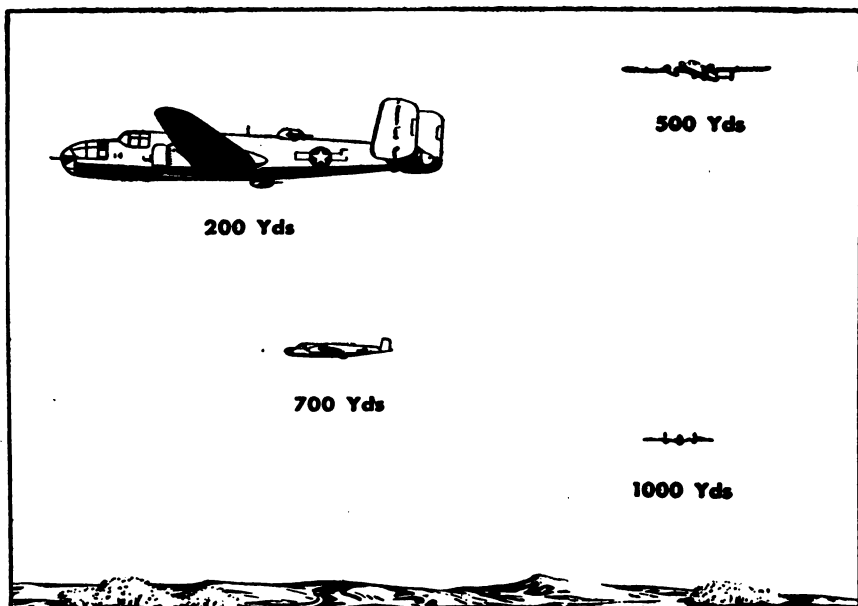


Figure 92. Diagram illustrating the method of estimating the range by the appearance of the plane.

c. Training for estimating speed of aerial target, whenever possible, consists of having an airplane fly at known speed until all are familiar with the appearance of the various target speeds. Also, in concurrent aircraft recognition training the usual speeds of attack for the various types of enemy aircraft are covered.

#### **134. Position Exercise**

a. The purpose of this exercise is to teach the gunner to assume the antiaircraft firing position quickly and correctly. (For positions, see pars. 53, 61, and 68.)

b. The instructor must insure that each man assumes a stable position. The position of each man will be tested by having him swing a free gun in high elevation and in a wide traverse without reference to any target. After the gunner has learned the correct position, speed in assuming it will be acquired by practice.

#### **135. Tracking Exercise**

a. The purpose of the tracking exercise is to teach control of the free gun, and to stimulate firing in a continuous burst at aerial targets from varying angles. The radio-controlled airplane is the most suitable target for this type of exercise. The courses listed in table I, paragraph 143, should be flown until each gunner is capable of accurate and smooth tracking.

b. Tracking practice on any moving target develops hand-eye coordination. Airplanes, birds, and moving ground vehicles should be utilized as tracking targets. Lacking moving targets, practice may be obtained by tracking edges of buildings, telephone lines, or any straight line on the terrain. A flashlight fastened to the barrel of the gun and used to track a miniature airplane suspended on a wire may be used to advantage. A water hose, tied to the gun with a nozzle adjusted to give a fine stream of water, may also be used.

#### **136. Antiaircraft Machine Gun Trainer, M9**

a. PURPOSE. The antiaircraft machine gun trainer, M9, is a device which gives extensive and practical training prior to actual firing. (see fig. 93).

b. DESCRIPTION. For a description of the trainer, see TM 9-221.

c. METHOD OF USING TRAINER. (1) The trainer requires three men: the machine gunner, the operator of the target towing mechanism, and the operator of the sound effects. As the sound effects interfere with instruction during the firing, necessary instruction is presented before

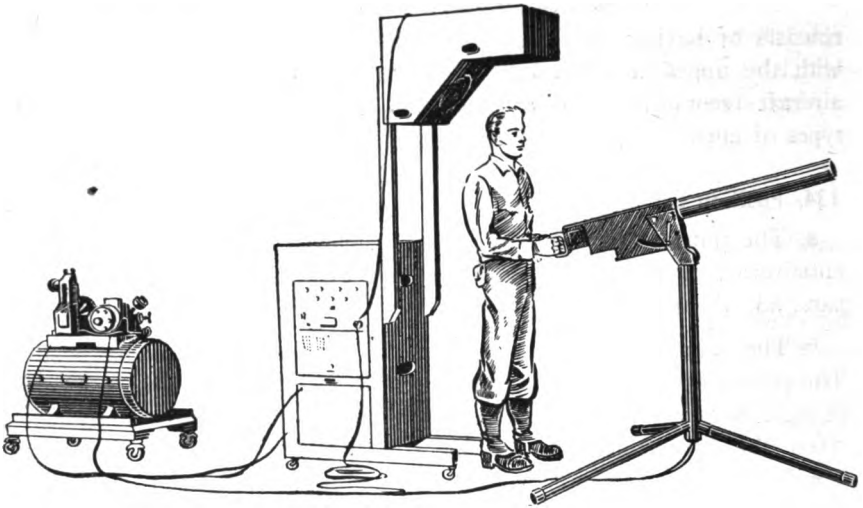


Figure 93. Antiaircraft machine gun trainer, M9.

firing begins and at suitable intervals between courses. Training groups are kept small.

(2) Gunners should not sight along the barrel. Instead, the eyes should be concentrated on the model plane and the tracer stream near it. They must practice individual tracer control on the trainer just as they would when firing the machine gun. Gunners should wear a pair of glasses, one glass of which is opaqued or covered. In this manner, depth perception, which is considerable at the short ranges involved, is made to approximate the true conditions more closely.

(3) The trainer develops hand-eye coordination so that the gunner instinctively traverses and elevates (or depresses) the gun smoothly and accurately in tracking. It also demonstrates the necessity for adequate opening leads, since the gunner quickly discovers that it is much easier to drop back on the target than to catch up.

(4) The target rate can be varied at will, simulating actual target speeds. By changing the relative positions of the target and trainer, a great variety of courses is possible. By changing the target support wire, the target can be made to dive at any desired angle.

*d. ADVANCED TRAINING.* More varied and complex courses under difficult day and night conditions are simulated with as much realism as possible. Gas masks should be worn by the gunner for part of this training.

*e. RECORDS.* During the training period on the trainer, M9, perfor-

mance records should be kept to determine the relative ability of each man. Type of course, number of course, hits, and remarks are generally sufficient entries.

*f.* **LIMITATIONS.** It is to be kept in mind that use of this trainer will not in any way substitute for actual antiaircraft firing.

### **137. Demonstration Firing**

*a.* **PURPOSE.** The purpose of this firing is to familiarize the gunner with the curved appearance of the tracer stream, to show him the key ranges on that stream, and to demonstrate the correct application of the stream to a target.

*b.* **DEMONSTRATIONS.** The firing consists of the following demonstrations:

(1) Without reference to a target, traverse a free gun, while firing to show the curved appearance of the tracer stream, calling attention to the necessity of having the head high over the gun in order to observe through smoke.

(2) Fire at aerial targets, both coming and crossing, demonstrating how lead is increased as the target approaches the midpoint.

### **138. Firing Exercise**

*a.* **PURPOSE.** The purpose of the firing exercise is to teach control of the free gun while pointing and firing a long, continuous burst.

*b.* **FIRING AT BALLOONS.** Free balloons, released in a wind, permit firing at a moving aerial target. While firing at balloons gives only limited training in manipulation of the machine gun, it gives the gunner an opportunity to observe the normal trajectory and time of flight. Hits are immediately apparent and adjustment is possible. It must be remembered that balloons have value only as preliminary training targets. A minimum of time and ammunition should be spent on balloon firing.

*c.* **FAULTY TRAINING METHODS.** Firing at stationary targets and on a miniature antiaircraft ranges *must not be used as training methods for antiaircraft firing.* Antiaircraft firing without use of tracers is wasteful and useless for training; errors cannot be seen and corrected, and although a few hits may be obtained, the gunner never knows at what time and with what lead they were obtained.

*d.* **ESSENTIALS FOR FIRING.** Before beginning a firing exercise, the instructor will explain the importance of firing with the proper position and with a firm grip on the gun, and of firing a free gun in a long, continuous burst. In instruction firing, the instructor, or his assistant.

and coaches will carefully check each man before and during firing to see that he observes these essentials.

### Section III. ADVANCED TRAINING: TOWED-TARGET AND RADIO-CONTROLLED PLANE-TARGET FIRING

#### 139. General

Firing at towed targets and radio-controlled plane targets is the final phase of antiaircraft machine gun practice. It consists of firing the caliber .30 machine gun at a target towed by an airplane or at a radio-controlled plane target, or both.

#### 140. Types of Targets Employed

*a. TOWED TARGET (SLEEVE).* (1) *A-7.* This sleeve is 15 feet long, with a diameter of 26 inches at the forward end and 12 inches at the rear end. It is towed by a unit of the Army Air Forces. The speed varies with the type of airplane but is usually around 150 miles per hour.

(2) *A-7 Modified.* This sleeve is 15 feet long with a diameter of 26 inches at the forward end and 5 inches at the rear end. It is towed by the artillery type liaison plane. The speed is usually around 70 miles per hour.

*b. TOWED-FLAG TARGET.* This target is 40 feet by 9 feet, equipped with weights so that the width (9 feet) is displayed to the gunner when the target is moving directly toward or away from the firing line, or across the front. It is towed by a unit of the Army Air Forces. The maximum speed using this target is approximately 10 percent more than with the A-7 target.

*c. RADIO-CONTROLLED-PLANE TARGET.* The radio-controlled plane target is approximately 10 feet long with a 12 foot wing spread and a height of approximately 2 feet. Its speed is 100 to 150 miles per hour. (See TM 20-300.)

#### 141. Requirements for Towed-sleeve and Radio-controlled Plane Target Firing

*a. PERSONNEL TO FIRE.* Whenever time, ammunition, range, and planes or targets are available, the officers and enlisted men are authorized in AR 775-10 will be required to fire moving aerial target practice.

*b. FIRING GROUP.* When possible, only one gun will fire at a time; however, up to four guns may fire as a group. The results of the firing

for each gun may be determined by the use of different colors of printer's ink on the noses of the bullets. (See app. III).

c. **SOURCE OF TARGETS.** Towed-flag targets and the A-7 tow targets are furnished by the air force unit assigned the towing mission. They are returned to the air force unit after they have been scored. A-7 modified tow targets and radio-controlled plane targets are obtained through the division commander.

#### 142. Range Operation

a. The firing line is so designed that the officer in charge can be readily seen from all guns. Firing points are as widely spaced as positive control by the officer in charge permits.

b. The officer in charge of firing announces the direction from which the target will approach and, on the approach of the target, gives the command to load. As the target enters the ground sector of fire (passes the safety limit), the safety officer stationed at the *opposite* end of the firing line from which the target approaches, gives the signal to COMMENCE FIRING. The signal is given as the target enters the ground sector of fire *as observed from that officer's position*. All firing ceases on a similar signal. The signal to CEASE FIRING is given before the target leaves the ground sector of fire as observed from the position of the safety officer on the side from which the plane approached. The lines on the ground which indicate the points at which CEASE FIRING is given must be located far enough inside the flank limits of fire to include the maximum lateral leads for the shortest range to be used.

c. All firing will be controlled by appropriate instructions, orders, and signals. Visual signals will be used for COMMENCE FIRING. Klaxon, siren, or other noise making signals are used exclusively for CEASE FIRING. These signals are given by the officer controlling fire. A coach is provided for each gun position. To insure that the individual gun does not exceed the safe limits of the field of fire and fire in a danger area, a safety man is placed in the rear of each gun where he may watch the pointing of the gun and be seen by the coach.

#### 143. Courses

Depending upon the ammunition available, a selection of the courses to be fired should be made from table I. At least one coming course will be required. The number of rounds to be fired on each run will vary with the range; 20 to 40 rounds per gun at ranges of 300 yards or less, and 40 to 80 rounds per gun at ranges beyond 300 yards. If possible, one run should be fired with solid tracer loading and the other runs with mixed loading depending upon the ammunition available.



Table I

Type target	Course number	Type course	Altitude (feet)	Slant range at midpoint (yards)	Remarks
Tow-target A-7 or towed flag target.	1	Crossing (level)	300	300	Parallel to firing line from R to L or L to R.
	2	do	600	400	Do.
	3	do	900	500	Do.
	4	do	1,200	600	Do.
	5	do	1,200	700	Do.
	6	Coming (level)	900		Open fire at 700 yards slant range; cease fire at 350 yards, slant range.
Tow-target A-7 (modified).	7	Crossing (level)	800	300	Parallel to firing line from R to L or L to R.
	8	do	800	500	Do.
	9	Coming (level)	800		Open fire at 400 yards slant range; cease fire at 300 yards, slant range.
Radio controlled plane target.	10	Crossing (level)	200	300	Either parallel or oblique to firing line, R to L or L to R.
	11	do	800	400	Do.
	12	do	1,200	500	Do.
	13	do	1,000	600	Do.
	14	do	900	700	Do.
	15	Coming (level)	750		Open fire at 700 yards, slant range; cease fire at 300 yards, slant range.
	16	Coming (diving) (See fig. 94.)	750(A)- 250(B)		Open fire at 700 yards, slant range (A); cease fire at 175 yards slant range (B).
17	Crossing (diving) (See fig. 94.)	1,000(C)- 600(D)		Open fire at 700 yards, slant range (C); cease fire at 300 yards, slant range (D).	

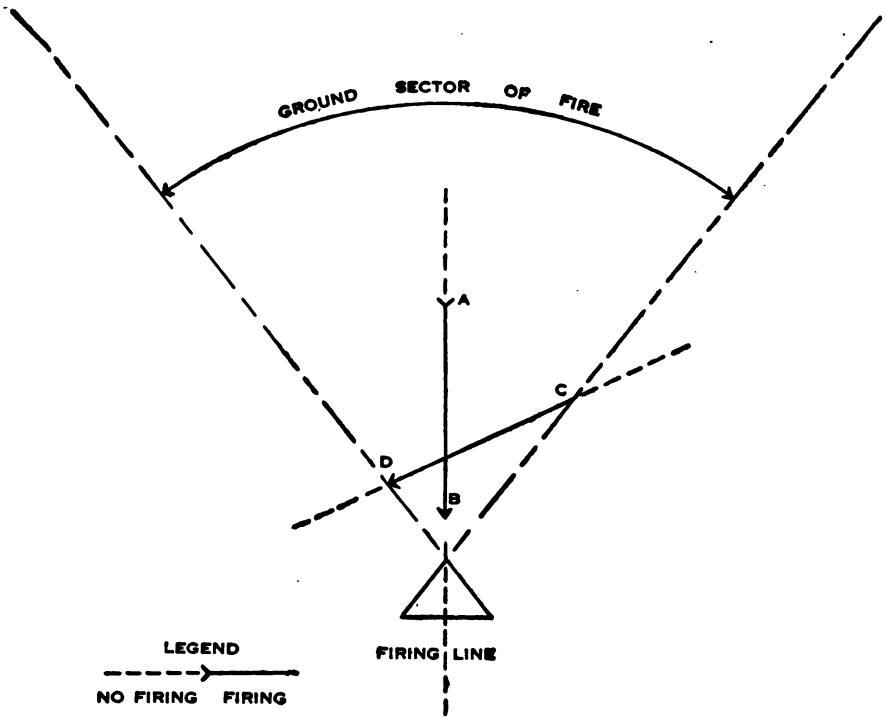


Figure 94. Suggested course for radio-controlled airplane.

#### 144. Fire Orders

Examples of fire orders for aerial target firing are as follows:

*a.* CROSSING COURSES.

LOAD.

LAY ON RIGHT (LEFT) SAFETY LIMIT.

TRACK THE TARGET. (Sufficient time is allowed for safety men to insure gunner is not tracking towing plane.)

COMMENCE FIRING (Signal.)

CEASE FIRING (Signal.)

CLEAR GUNS.

*b.* COMING COURSES.

DEPRESS.

LOAD.

TRACK THE TARGET.

COMMENCE FIRING. (Signal.)

CEASE FIRING. (Signal.)

CLEAR GUNS.

## 145. Instructions to Aerial Target Personnel

*a. GENERAL.* Antiaircraft machine gun practice demands a thorough preparation of all details connected with aerial target firing and the closest cooperation between the pilot of the towing plane, or the personnel in charge of the radio-controlled plane target, and the officer in charge of the firing. Decisions affecting the safety of the towing plane rest with the pilot.

*b. REQUEST FOR PLANE.* The commanding officer requesting planes should furnish in writing to the air force unit commander or the division artillery air officer the following information:

- (1) Place, date, and hour of firing.
- (2) Number of missions to be flown, including speed, altitude, course, and number of runs for each.
- (3) Map of the firing area, with the angle of fire, firing line, and course of each mission plotted thereon.
- (4) Ground panel signals to be displayed, if radio is not to be used.
- (5) Number of targets to be carried on each flight.
- (6) Location of the dropping ground for dropping targets and messages, or the take-off and landing location in the case of radio-controlled airplanes. An alternate dropping ground should be designated when practicable. (Dropping grounds are subject to approval of the pilot.)

*c. MARKING COURSES ON GROUND.* The courses over which the plane is to be flown should be marked on the ground (within the angle of fire). Machine gun targets placed flat on the ground about 30 feet apart, or strips of target cloth are practicable for this purpose on some courses. Terrain features such as beach lines and other conspicuous natural markings may also be used.

*d. GOING OVER GROUND WITH PILOT.* When practicable, the officer in charge of the firing will go over the ground with the pilot and point out to him the location of the firing line, the angle of fire, and the dropping grounds.

## 146. Inspection of Guns and Ammunition

Prior to aerial target firing, all guns and ammunition will be inspected in order to avoid stoppages and to insure smooth functioning of guns and continuous fire.

## 147. Signals

Direct radio communication is the most effective method of controlling changes in target courses and the dropping of sleeve targets. When radio is not available, the ground may communicate with the airplane

by means of panels, and the airplane with the ground by means of dropped messages. Even though radio is being used, panels should be available in case radio communication fails. For signaling from the ground to the pilot, any intelligible method agreed upon may be used.

#### 148. Safety Precautions

a. Towed target firing safety regulations, angle of fire, tow cable lengths, and location of safety limits are prescribed in AR 750-10.

b. See TM 20-300 for safety precautions required when using radio-controlled airplane targets.

c. The following additional precautions are prescribed in training:

(1) At the command CEASE FIRING, the coach at each machine gun hits the gunner smartly on the back or hand. In some cases it may be necessary to remove physically the gunner's hand from the trigger. Whenever the gunner fires into unsafe fields of fire, the safety man at the machine gun will immediately hit the gunner smartly on the back or hand.

(2) No live ammunition is allowed near the machine guns except when firing is taking place.

(3) The covers on all machine guns are raised and the guns unloaded except when the guns are firing or about to fire.

(4) When tracking a target, the gunner does not touch the trigger until the gun is aligned on the target and the field of fire has been declared safe.

(5) A gun will not be pointed at or near a towing plane. *All tracking will be on the towed target.*

(6) At the beginning courses, machine guns must be kept depressed considerably below the elevation of the towing airplane until it has cleared the line of sight.

(7) While a stoppage is being cleared, or malfunctioning resulting in continuous fire is being remedied, the machine gun is pointed at a safe part of the field of fire.

(8) During training firing where guns are arranged to simulate combat positions, extreme precautions must be taken to observe every possible precaution against accident to personnel. The measures taken include the use of machine gun pits, sandbags, and minimum elevation stops on the machine guns.

(9) In all cases where aerial targets are towed over or close to the gun positions at low altitudes, provision must be made for the safety of personnel against a dragging towline cable. The cable may drag if

it is broken, if the target is accidentally released, or when the last target is dropped.

d. At least two safety officers will be designated to assist the officer in charge of firing in carrying out safety precautions.

#### **149. Additional Precautions for A-7 Modified Tow Target**

a. The sleeve should be launched by placing it the full length of the towline to the front of the plane, and a few feet to the right or left.

b. The runway should be at least  $\frac{1}{2}$  mile in length with clear approaches for an additional half mile.

c. A towing speed of 70 miles per hour should be maintained. Minimum altitude while turning should be 600 feet.

#### **150. Scoring**

The number of hits made on a double-surface target is determined by dividing the number of bullet holes in the target by two. In the case of radio-controlled plane targets, allowance must be made for bullets lodged in the plane, passing through solid parts, carrying away parts, or being deflected after striking a solid part. The score for firing on a single-surface target is the number of bullets shown thereon. As each bullet hole is counted, it should be patched or clearly marked so that it will not be used as a part of a subsequent score.

#### **151. Analysis of Firing**

The officer in charge of firing will record the number of hits, rounds of ammunition expended, and the actual time of firing for each run fired. From this data, he will compute the percentage of hits and the number of hits per gun per second. Hits per gun per second will be based on the total firing time for each run, taken between the signals COMMENCE FIRING and CEASE FIRING. Results expressed in average hits per gun per second for the platoon or company give a clear understanding of its fire effect, in terms of hits upon the target. Results stated in percentages indicate the effectiveness of its fire in terms of ammunition expended.

## CHAPTER 6

### TECHNIQUE OF FIRE: DIRECT LAYING

---

#### Section I. GENERAL

##### 152. Scope

a. Direct laying is pointing a machine gun for direction and elevation so that the sights are aligned directly on the target. It involves knowledge and application of the following subjects:

- (1) Characteristics of fire.
- (2) Classes of fire.
- (3) Range determination and windage.
- (4) Target designation.
- (5) Fire distribution.
- (6) Fire control.
- (7) Employment of an auxiliary aiming point.
- (8) Fire orders.
- (9) Overhead fire.
- (10) Final protective lines.
- (11) Range cards.

b. Although the methods employed in firing from position defilade (ch. 7) and under conditions of poor visibility (sec. IX of this ch.) may *technically* be classified as those of indirect laying, nevertheless, because of their simplicity and very slight departure from direct laying methods, they are ordinarily classified under the heading of direct laying.

##### 153. Marksmanship

Training in machine gun marksmanship (ch. 3) is a prerequisite to instruction in direct laying.

#### Section II. CHARACTERISTICS OF FIRE

##### 154. Trajectory

The trajectory, or path, of a projectile through the air is influenced by three forces, velocity of the projectile, gravity, and air resistance.

The farther the bullet travels, the greater becomes the curvature of this path. The highest point on the trajectory (maximum ordinate) is a point approximately two-thirds of the range from the gun to the target. (See figs. 95 and 96.)

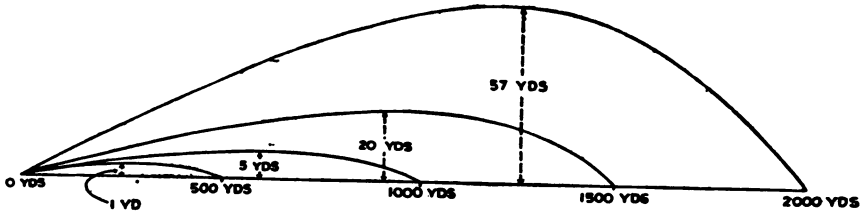


Figure 95. Maximum ordinates for M2 ball ammunition. (Vertical scale is 10 times the horizontal.)

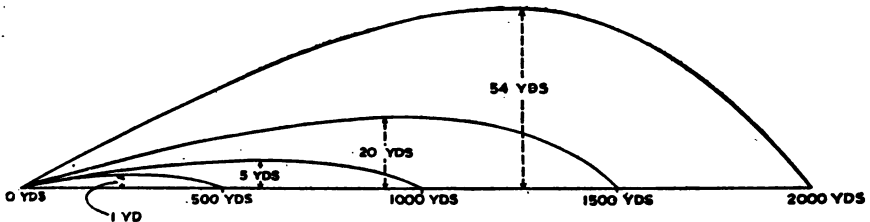


Figure 96. Maximum ordinates for M2 armor-piercing ammunition. (Vertical scale is 10 times the horizontal.)

### 155. Burst of Fire

The number of shots in a burst of fire depends upon several factors, including the size and shape of the target, ground formation, and ammunition supply. For normal ground targets, the number of rounds in each burst will vary from about 6 to 20 for the heavy gun, and from 6 to 10 for the light gun.

### 156. Cone of Fire (fig. 97)

When a burst is fired, the vibrations of the gun and tripod, variations in ammunition, and atmospheric conditions give each bullet a trajectory differing slightly from that of the others. The resulting group of trajectories is known as the cone of fire. At ranges up to 750 yards over level or uniformly sloping ground, the center of the cone of fire does not rise above the height of a standing man. With each increase in elevation of the gun, there is a further rise of the cone above the ground.

### 157. Beaten Zone

The beaten zone is the long, elliptical pattern formed by the intersection of the surface of the ground with the cone of fire.

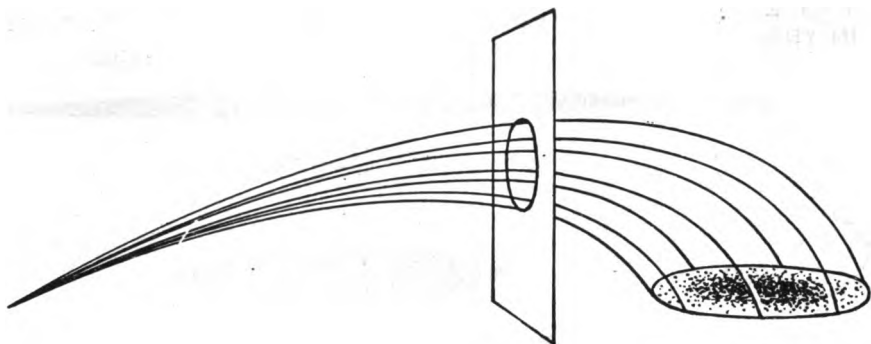


Figure 97. Cone of fire.

a. **EFFECT OF SLOPE OF GROUND.** When the cone of fire falls on level ground which is at the same height as the gun, the lengths of the beaten zone are as given in figures 98 and 99. The maximum length is obtained when the slope of the ground approximates the angle of fall of the bursts. On rising ground, the length of the pattern is shortened. The minimum length occurs where the slope of the ground is perpendicular to the cone of fire at the point of impact. (See fig. 100.)

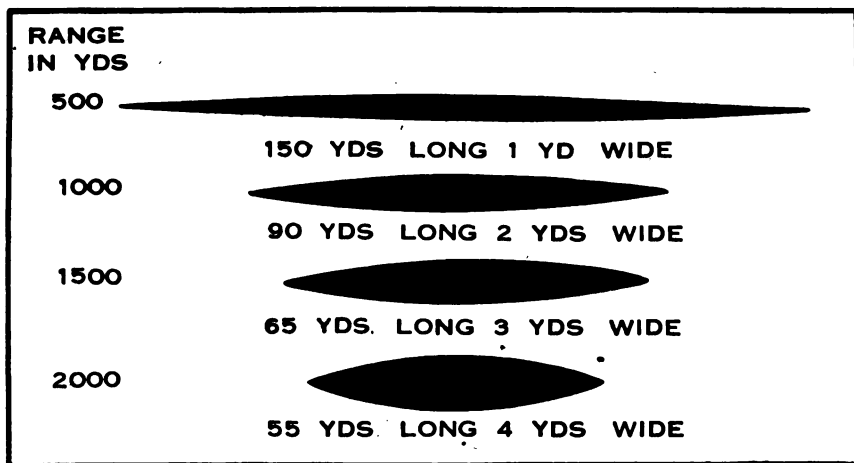


Figure 98. Approximate dimensions of beaten zones on level ground for M2 ball ammunition.

b. **EFFECT OF RANGE.** As the range increases, the beaten zone becomes shorter and wider. (See figs. 98 and 99.)

c. **CENTER OF IMPACT.** The center of the beaten zone is called the center of impact. (See fig. 101). It has been found that 82 percent of



**RANGE  
IN YDS.**

**500**



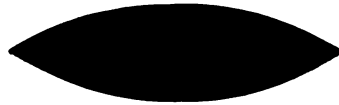
**146 YDS. LONG - 2 YDS. WIDE**

**1000**



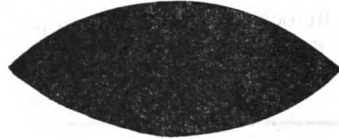
**71 YDS. LONG - 7 YDS. WIDE**

**1500**



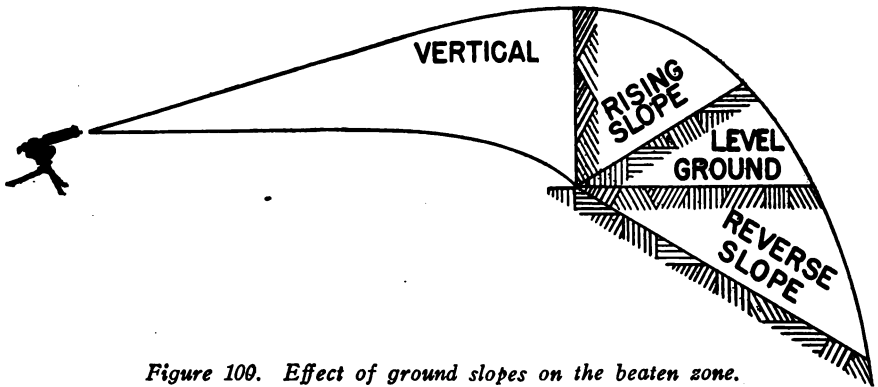
**61 YDS. LONG - 12 YDS. WIDE**

**2000**



**61 YDS. LONG - 17 YDS. WIDE**

*Figure 99. Approximate dimensions of beaten zones on level ground for M2 armor-piercing ammunition.*



*Figure 100. Effect of ground slopes on the beaten zone.*

the shots are uniformly grouped around the center of impact. These comprise the 82 percent or effective beaten zone. The remaining 18 percent of the shots are so scattered that they are considered to be outside of the effective beaten zone.

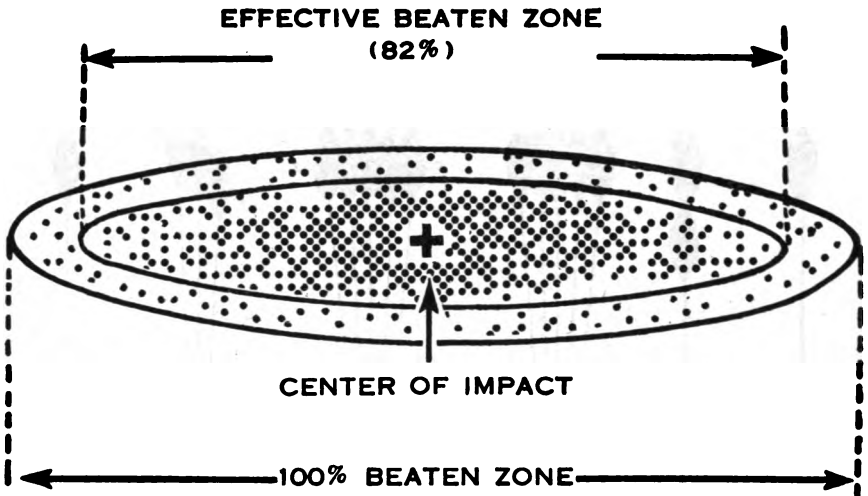


Figure 101. Distribution of shots in beaten zone.

### Section III. CLASSES OF FIRE

#### 158. Classes of Fire with Respect to Gun (fig. 102)

a. **FIXED FIRE.** Fixed fire is fire delivered on a point target. The depth of the beaten zone must be sufficient to include the target. Fire is continuous as long as any portion of the target remains in the zone of fire.

b. **SEARCHING FIRE.** Searching fire is fire distributed in depth by successive changes of elevation of the gun. Searching fire is used against targets too deep to be included in the beaten zone of fixed fire. A burst of fire is delivered after each change of elevation. The amount of change depends upon the range and the conformation of the ground. On level ground, with the target at the same elevation as the gun, a change of 2 mils is usually employed because it causes the successive beaten zones to overlap.

c. **TRAVERSING FIRE.** (1) *General.* Traversing fire is fire distributed in width by successive changes in the direction of the gun. A burst of fire is delivered after each change of direction. The exact amount of change in direction after each burst depends upon the range and density of the target. If dense fire is desired, a 2-mil change in direction will usually cause sufficient overlap of the beaten zones.

(2) *Swinging traverse.* Swinging traverse is employed against moving targets when fairly rapid changes in direction, but not in elevation, and continuous firm control of the gun are desired. Targets may be dense targets of considerable width in relatively close formations moving

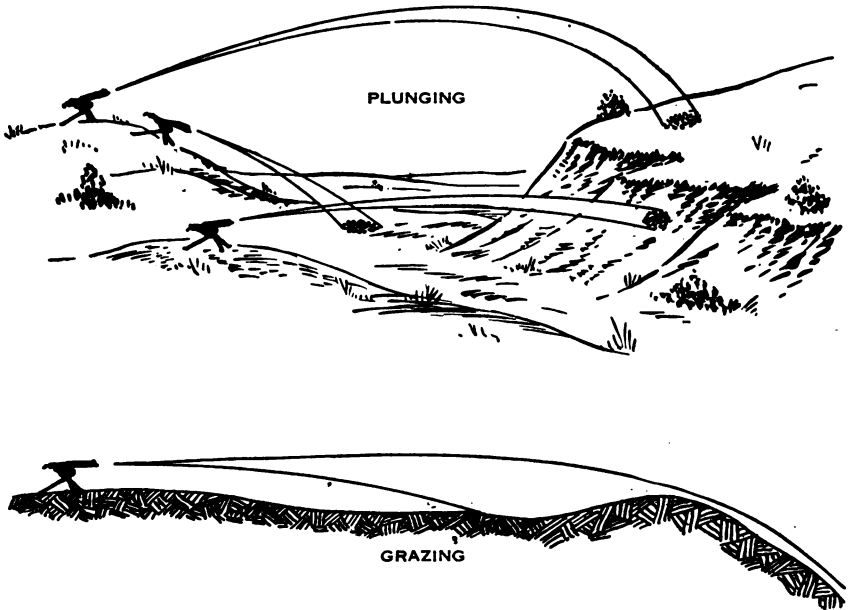
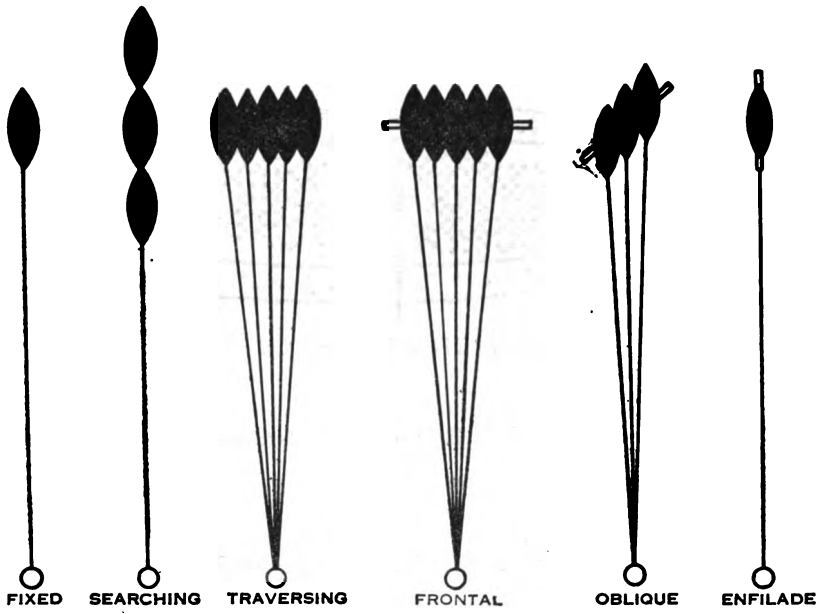


Figure 102. Classes of fire.

slowly toward the gun, or vehicles or mounted troops moving across the front parallel or approximately parallel to the gun position. The traversing clamp or traversing slide clamp, as the case may be, is loosened only sufficiently to permit the gunner to swing the gun by exerting strong lateral force against the grip. The M1919A6 gun, on bipod mount, is traversed by shifting the position of the shoulders and body. The gun is laid on any portion of the target and traversed while being fired continuously.

(3) *Free gun.* This type of fire is used against aircraft and against moving targets which must be rapidly engaged with rapid changes in elevation and deflection, such as vehicles, mounted troops and infantry in relatively close formations moving rapidly toward or away from the gun position. The elevating and traversing clamps are loosened so that the gun can be freely swung in any direction with a minimum of resistance. The gun is traversed while being fired continuously, tracer control being employed. (See par. 123c.)

(4) *Waste of ammunition.* Firing with both swinging traverse and free gun are wasteful of ammunition, and should not be resorted to without a good reason.

d. **TRAVERSING AND SEARCHING FIRE COMBINED.** Combined traversing and searching fire is fire distributed both in width and depth by changes in direction and elevation. It is employed against targets whose longer axes are oblique to the direction of the fire, when the difference in range to the far and near ends is greater than the depth of the beaten zone. Changes in direction and elevation are made successively after each burst. The traverse will usually be 2 mils; the amount of search will depend on the obliquity of the target.

### 159. Classes of Fire with Respect to Target (fig. 102)

a. **FRONTAL FIRE.** Frontal fire is fire delivered at right angles to the front of the objective.

b. **FLANKING FIRE.** Flanking fire is fire delivered against the flank of a target.

c. **OBLIQUE FIRE.** Oblique fire is fire delivered so that the long axis of the beaten zone is at an oblique to the long axis of the target.

d. **ENFILADE FIRE.** Enfilade fire is fire, either frontal or flanking, in which the long axis of the beaten zone coincides or approximately coincides with the long axis of the target.

### 160. Classes of Fire with Respect to Ground (fig. 102)

a. **PLUNGING FIRE.** Plunging fire is fire in which the angle of fall of the bullets with reference to the slope of the ground is such that the

danger space is practically confined to the beaten zone and the length of the beaten zone is materially shortened. Plunging fire will occur when firing from high ground unto low ground, firing into abruptly rising ground, and when firing at long ranges.

*b.* **GRAZING FIRE.** Grazing fire is that fire in which the center of the cone of fire does not rise above the height of a standing man. A gun fired over level or uniformly sloping ground will produce grazing fire at ranges up to 750 yards.

#### **161. Effect of Proper Location of Guns**

Targets should always be engaged by flanking enfilade fire if possible. No enemy will knowingly present such a target, therefore flanking enfilade fire will usually be obtained by skillful selection and effective camouflage of gun positions.

### **Section IV. RANGE DETERMINATION AND WINDAGE**

#### **162. Importance of Accurate Range Determination**

Damp ground or poor visibility often make adjustment of fire by observation impossible. Under such conditions, the cone of fire may miss the target completely, though an error in range no greater than 100 yards exists. Therefore, correct range determination is highly important for effective machine gun fire.

#### **163. Extreme Usable Ranges**

In direct laying, the extreme usable range is that range at which the target is visible to the gun crew at the gun. This range varies with the terrain and visibility and, in general, will not exceed 2,000 yards. Once observation of fire becomes impossible, fire should be considered as area rather than precision fire.

#### **164. Means of Range Determination**

*a.* Ranges may be determined by any of the following means:

- (1) Estimating by eye.
- (2) Firing the gun.
- (3) Measuring the range from a map or aerial photograph.
- (4) Securing data from other units.
- (5) Range-finding instruments.

*b.* All ranges should be verified by firing the gun whenever the tactical situation permits.

### 165. Range Estimation by Eye

For methods of range estimation by eye, see paragraph 106.

### 166. Use of Range Finders (M1917A1 Machine Gun Only)

For the method of determining range with range finders, see TM 9-585.

### 167. Firing Gun

a. In determining the range by firing the gun, the gunner opens fire on the target at the estimated range, moves the center of impact into the target by means of the elevating and traversing mechanism, resets the rear sight so that the line of aim is on the target, notes the sight setting on the rear sight, and announces it as the range to the target. All guns are then laid, and fire is opened by command of the unit leader. To use this method, all guns must have been previously zeroed in order that the range determined for one gun may be used for the others.

b. When the ground in the vicinity of the target permits no observation of strike, or when it is desired to obtain surprise, fire is adjusted on a point which does offer observation and which is known to have the same range as the target. The gunner lays his gun on the target when ordered.

c. When engaging targets in a tree or building, fire is adjusted on the ground at the foot of the tree or building, where the strike of the bullets will be visible. The range thus determined is taken as the range to the target. The gunner announces the range and elevates his gun until it is laid on the target.

### 168. Windage Corrections

For the procedure in making windage corrections, see paragraph 108.

## Section V. ELEMENTS OF FIRE ORDERS

### 169. General

The decision to fire on a target from a certain position having been made, the technical instructions as to how the target is to be engaged, whether by squad, section, or platoon, are given in a fire order.

### 170. Basic Elements of Fire Orders

A correct fire order is one which is *as brief as clarity permits* and which directs, in the sequence in which they must be performed, the actions necessary for the accomplishment of a fire mission. Three basic ele-

ments are announced or implied in every case. Although only such parts of these as are essential are included, the sequence must always be as follows:

- Target designation element.
- Fire distribution element.
- Fire-control element.

## Section VI. TARGET DESIGNATION

### 171. Preliminary Training

As a preliminary to practical work in target designation, machine gunners must have a knowledge of the military and topographical (fig. 103) terms employed in designating targets; for example, flank, skirmishers, column, patrol, crest, hill, cut, ridge, and crossroads. They should also be instructed in the meaning and use of such terms as horizontal, vertical, above, below, rectangle, square, triangle, mil, yard, and pace. A thorough course in visual training and range estimation is also necessary.

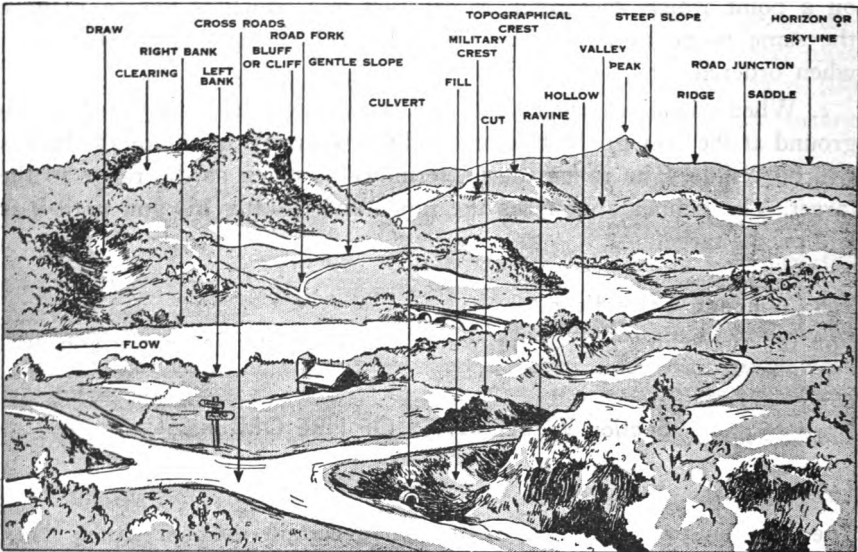


Figure 103. Topographical terms.

### 172. Methods of Designating Targets

The following methods are used to designate targets:

- Oral designation.
- Firing a machine gun or rifle.
- Laying the gun.

**a. ORAL DESIGNATION.** By the oral designation method information comprising the target designation element is given orally, arm signals and pointing, when applicable, supplementing the spoken word. The essential parts of an oral designation are announced in the following sequence:

Range.

Direction.

Description of the target.

(1) *Range.* The range is followed immediately by windage correction, if necessary. For example: RANGE 600; SIGHT LEFT 4.

(2) *Direction.* Whenever practicable, the direction should be given by pointing, using only such words as are necessary. "Front" is understood as the direction of the enemy or the direction in which the muzzle points, and directions varying therefrom by successive angles of 45° are designated as "right (left) front," "right (left) flank," "right (left) rear." One of the best methods of designating very obscure targets is to use successive reference points. A clearly distinguishable reference point is first designated. The gunner is then led step by step to the target by the naming of successive reference points until his line of aim is brought on the target. For example: RANGE 700; REFERENCE: RED-ROOFED HOUSE; TO RIGHT OF HOUSE, A HEDGE; CENTER OF HEDGE, GATE; JUST ABOVE GATE, TARGET: EDGE OF WHEAT FIELD. The word "reference" precedes the first point announced.

(3) *Description of target.* Usually a word or two is enough to describe the target; for example, "column," "that hedge," "skirmish line." If reference points are included in the order, the word "target" precedes the words describing the target.

**b. FIRING GUN OR A RIFLE.** Designating a target by firing a machine gun or rifle is a quick, sure, and simple method, but may disclose the gun position. The leader lays the gun on the target and then announces orally the range and directs the gunner(s) to watch his burst or tracers; for example, RANGE 500, WATCH MY BURST (TRACERS). He next fires one or more bursts on the target and completes the designation orally. For instance, in designating a wide or deep target he may fire two bursts, one at each extremity, announcing after each burst the flank or end of the target hit. A similar procedure is used in firing a rifle to designate the target. It is not necessary that the rifle be fired from the gun positions.

**c. LAYING GUN.** Laying the gun on a target is another quick, sure, and simple method, and does not sacrifice surprise effect. To use this method, the leader announces the range and direction and then goes to



each gun, lays it on the target, requires the gunner and observer at the gun to check the laying, and completes the designation orally. The oral designation should indicate the part of the target on which each gun is laid. For example: (lays No. 1 gun) NEAR END: (lays No. 2 gun) FAR END: HALTED COLUMN. When it is anticipated that observation of strike or tracers will be difficult or impracticable, the leader must insure that the gunners know the extent of the target by laying *each* gun on *both* ends of the target. An example command would be: (lays gun) NEAR END: (lays gun) FAR END. HALTED COLUMN.

## Section VII. FIRE DISTRIBUTION

### 173. Distribution of Fire

a. **IMPORTANCE OF PROPER DISTRIBUTION.** Fire, to be effective, must be distributed over the entire target. Improper distribution results in gaps between beaten zones and allows a part of the enemy to escape or to use his weapons without effective opposition.

b. **FACTORS AFFECTING DISTRIBUTION.** No fixed rule as to the maximum width of a target that may profitably be engaged by a single machine gun can be given, although it is preferable that targets be less than 100 mils wide in the case of the heavy gun, and less than 50 mils in width in the case of the light guns on tripod mounts. If possible, targets exceeding the above widths should not be assigned to a single gun for the following reasons:

(1) The traversing mechanism limits the amount of traverse that can be secured without readjusting the traversing clamp or the traversing slide lock.

(2) Wider angles require appreciable time to traverse.

(3) The width of the cone of fire of a single gun is relatively narrow.

(4) The amount of ammunition required for a wider target is excessive for a single gun.

c. **THE NORMAL FIRE UNIT.** The section is the machine gun fire unit. Whenever practicable, at least two guns should be assigned the same mission, although occasions may arise when single guns may profitably be employed. The assignment of a section to a single mission insures continuous fire should either gun be put out of action, provides a greater volume of fire on the target, and reduces the time required to cover the target.

### 174. Method of Engaging Point Targets

Targets having a width or depth no greater than the beaten zone for

the ground on which they are located are considered as point targets, and should be engaged by fixed fire. The command for this type of fire is: **FIXED**. Gun crews are trained to follow any movement or change in formation made by the enemy after the initial burst of fire.

### 175. Method of Engaging Wide Targets (Traversing Fire)

a. **BY SECTION.** (1) *Targets less than 100 mils in width for the heavy machine gun and less than 50 mils in width for the light machine guns.* When sections engage frontal targets which are less than 100 mils in width for the heavy gun and less than 50 mils in width for the light guns and are also less than the length of the beaten zone in depth, the normal traversing method is used. Each gun is laid just outside its corresponding flank of the target and traversed across to a point just outside the other flank and back, each gun covering the entire target. (See fig. 104). The command for this type of fire is: **TRAVERSE**.

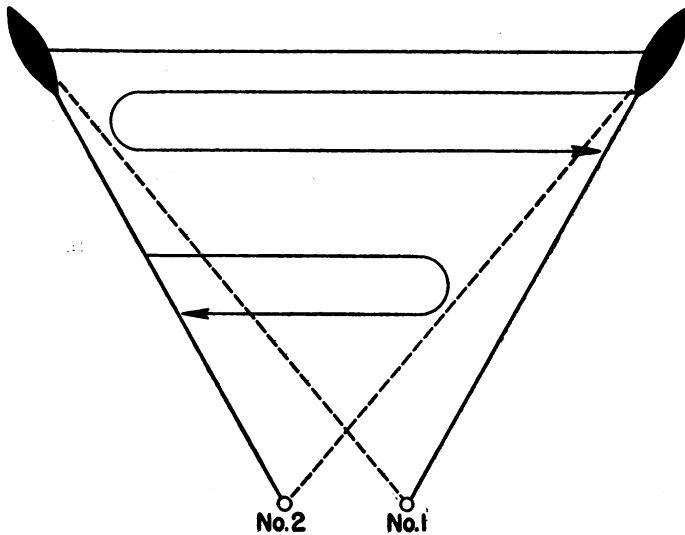


Figure 104. Traversing method by section. Both flanks visible to gunners.

(2) *Targets 100 mils or more in width for heavy machine gun and 50 mils or more in width for light machine guns.* When the target measures 100 (50) mils or more in width, and is less than the length of the beaten zone in depth, the leader assigns half (or any other portion) of the target to one gun, and the remaining half (portion) to the other gun. The assigned half (portion) may or may not correspond to the position of the gun in the section, and one portion may be much less than the other for purposes of increasing the density of fire on the smaller

portion. In either case, the gun lays on the outside flank of its assigned portion of the target and covers its portion as described in (1) above, and shown in figure 105. The command would be, for example: NO. 1, RIGHT HALF: NO. 2, LEFT HALF: TRAVERSE.

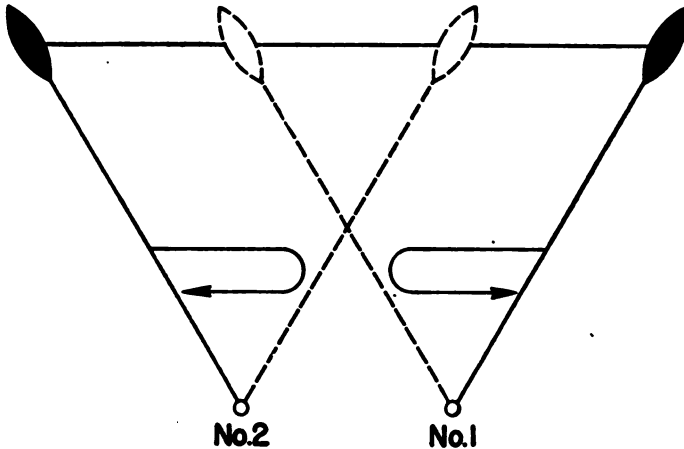


Figure 105. Traversing method by section. Targets 100 mils or more in width. (Each gun assigned a portion of the target.)

b. BY PLATOON USING HEAVY MACHINE GUN. (1) Each section engages the entire target as prescribed in *a* above (fig. 106), except when engaging extremely wide targets.

(2) In engaging extremely wide targets, each section may be assigned one-half (or any other portion) of the target. Each portion is assigned and designated separately as an individual section target. Each section covers its target by either of the section methods, depending upon the width of the target.

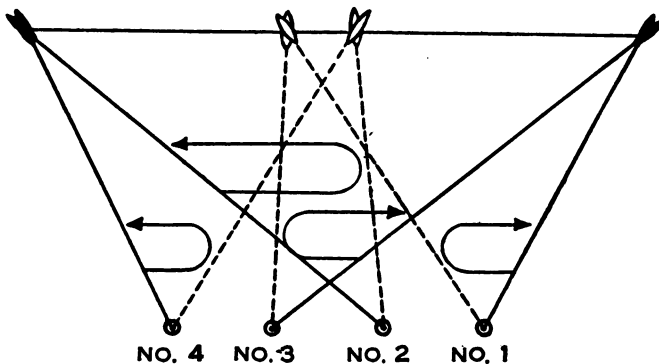


Figure 106. Traversing method by a platoon. Target 100 mils or more in width. (Each section covers entire target.)

c. **ENGAGING WIDE TARGETS, FLANKS OF WHICH CANNOT BE SEEN BY GUNNER.** If the flanks of the target are invisible to the gunner, the target may be designated as extending so many mils (or so many yards with M1919A6 gun on bipod) from a point between the flanks which is visible to the gunner. (See fig. 107). The number of mils (yards) designated should be such as to cause the gun to traverse just beyond the flanks. Each gun is then laid on this visible point, called the reference point, and traversed the number of mils (yards) designated on one direction and then back the number of mils (yards) designated in the other direction.

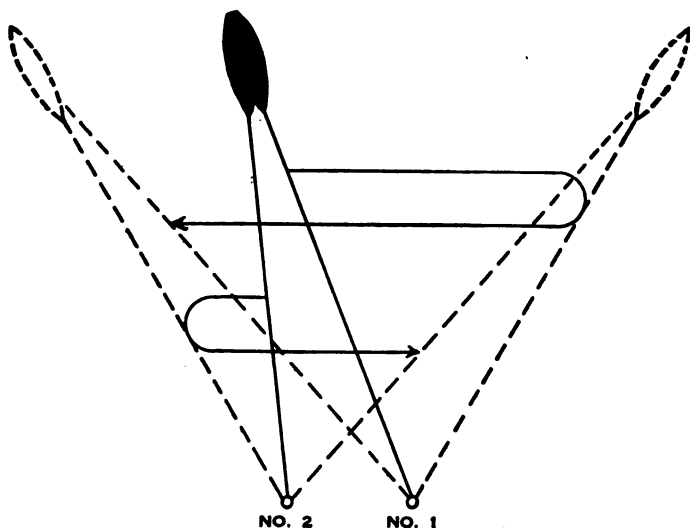


Figure 107. Traversing method by section. Both flanks invisible to gunner.

d. **SWINGING TRAVERSE.** The swinging traverse method, used against massed or rapidly moving targets at short range, is described in paragraph 158c.

### 176. Method of Engaging Deep Targets (Searching Fire) (fig. 108)

a. **BY SECTION.** (1) *Stationary target, ends visible to gunner.* If the target is stationary, has limited mobility, or is moving slowly, and the ends are visible to the gunner, No. 1 gun is laid on the near end and searched up and No. 2 gun is laid on the far end and searched down. If the depth of the target is estimated to be 200 yards or less, the range announced for both guns is that to the middle of the target. If the depth of the target is estimated to be more than 200 yards, the range to the near end is announced for No. 1 gun, and that to the far end for No. 2 gun. The word "Range" is not repeated when two separate ranges are

announced. Under the above conditions, the target is covered by giving the command: SEARCH.

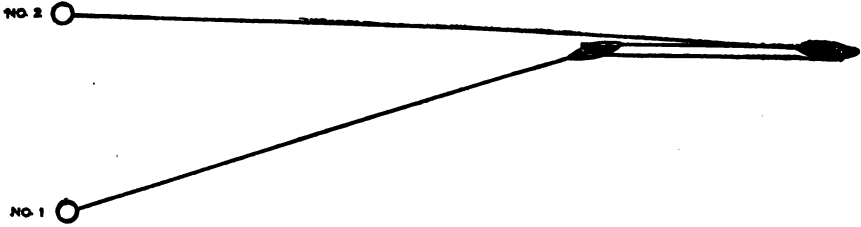


Figure 108. Section engaging a deep enfilade target.

(2) *Stationary target, ends invisible to gunner.* If the ends of the target are invisible to the gunner, the target is identified by tracer, or as extending so many mils from a reference point which is visible to the gunner and within or immediately adjacent to the target. The first method is the quicker and more simple of the two. Once the target is identified, it is covered in a manner similar to that described in (1) above. When designation by tracer is likely to disclose the gun position, or otherwise destroy the element of surprise, the second method may be followed. In this method, both guns lay on the announced reference point and each searches a designated number of mils until it is laid on a point computed as the limit of the target. When it is laid on this point, it proceeds to search as in (1) above, except that its limit of search is a designated number of mils, rather than a visible limit. For example, assume a target is 12 mils in depth, with a reference point at 4 mils from the far end. Having designated the reference point and the sight setting thereto, the leader commands: NO. 1, FIRST SEARCH DOWN 8 MILS, TOTAL SEARCH 12 MILS. NO. 2, FIRST SEARCH UP 4 MILS, TOTAL SEARCH 12 MILS. No. 1 searches down 8 mils and thereafter 12 mils, the latter alternately up and down. No. 2 searches up 4 mils, and thereafter 12 mils, the latter alternately down and up. The leader can compute the amount of search from the reference point in mils by the following method:

(a) Determine the ranges to the near and far ends of the target.

(b) From the firing tables, find the required angles of elevation (AE) in mils for both ranges and determine the difference. (For firing tables, see par. 2, table I, app. V, for M2 ball ammunition, or par. 13, table I, for M2 AP ammunition.)

(c) The difference between the AE's is the amount of search required on level ground with the gun and target at the same elevation. (If the fire is plunging, the amount of search must be increased.) If the com-

puted amount of search is an odd number of mils, it is raised to an even total so that search can be made in 2-mil increments.

(d) *Example.* (Computed from firing tables for M2 ball ammunition, par. 2, table I, app. V.) A deep target has been sighted, the ends of which are not visible to the gunners. A suitable reference point on the target is visible, the range to which is 1,100 yards. The depth of the target is estimated as 200 yards, and the reference point appears to be midway between the ends. Thus, the range to the near end is 1,000 yards; to the far end, 1,200 yards. The AE for a range of 1,000 yards is 15 mils; for 1,200 yards, 21 mils; the difference being 6 mils. This target thus extends 3 mils over and 3 mils short of the reference point. In order to search in 2-mil increments, the gunners will cover the target by searching 4 mils over and 4 mils short of the reference point, a total search of 8 mils. The distribution element of the command would be: OVER 4 MILS: SHORT 4 MILS: SEARCH.

(3) *Target moving away from gun position.* If the target is moving rapidly away from the guns, both guns are laid on the far end with the range to that point and searched down.

(4) *Target moving toward gun position.* If the target is moving rapidly toward the guns, both guns are laid on the near end with the range to that point and searched up. The distribution element of the command for covering a rapidly approaching or receding target is: ALL GUNS, FAR (NEAR) END, SEARCH.

b. BY PLATOON, USING HEAVY MACHINE GUN. A platoon uses the same method as the section, each section engaging the target as if it were acting alone. In case it becomes necessary to switch the fire of one section to another target, the original target is still covered by the remaining section.

c. SUBDIVISION OF TARGET. A deep target should never be subdivided.

### 177. Method of Engaging Oblique Targets (Combined Traversing and Searching Fire) (fig. 109)

a. BY SECTION. (1) *Less than 200 yards in depth and less than 100 mils in width for the heavy machine gun and less than 50 mils in width for light machine guns.* When the difference in range to the near and far ends of an oblique target is greater than the depth of the beaten zone, combined traversing and searching fire is used. Each gun is laid just outside its corresponding flank of the target with a range to the mid-point of the target, and traversed and searched across to a point just outside the other flank and back, each gun covering the entire target.

(2) *More than 200 yards in depth and greater than 100 mils in width for the heavy machine gun and greater than 50 mils in width for the*

*light machine guns.* Each gun is laid just outside its corresponding flank of the target with the range to that flank of the target. The leader assigns one gun to cover one-half (or any other portion) of the target and assigns the other gun to cover the remaining half (portion). Each gun then covers its own portion of the target as described in (1) above.

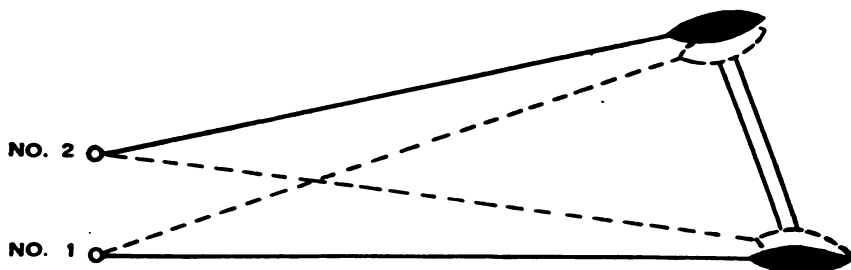


Figure 109. Section engaging a shallow oblique target.

(3) *Flanks invisible.* To engage an oblique target, the flanks of which are invisible to the gunners, the most expedient method of covering the target is for the leader to point out the locations of the flanks. He may do this by firing or laying the guns on the flanks, firing a rifle on each flank, or by pointing out the locations of the flanks by the use of successive reference points. After the locations of the flanks have been determined by the gunners, the target is engaged as in (1) and (2) above.

b. BY PLATOON, USING HEAVY GUN. A platoon uses the same method as the section, each section engaging the target as if it were acting alone. In case it becomes necessary to switch the fire of one section to another target, the original target is still covered by the remaining section.

## 178. Method of Engaging Area Targets

a. GENERAL. Targets which cannot be covered by either traversing fire or searching fire alone, or by combined traversing and searching fire, as in the case of an oblique target, are called area targets. The area which can be covered effectively by a machine gun section or platoon is small because of the time and ammunition required for this type of distribution.

b. BY SECTION. (1) *Flanks visible.* If the flanks of the target are visible to the gunner, the guns are laid just outside their corresponding flanks. Each gun then fires traversing fire across its assigned portion of the target, changes elevation the total amount prescribed in the initial fire order, traverses back to the flank from which traversing fire was started, and ceases firing. A typical distribution element of the command would be: TRAVERSE; SEARCH UP 4. Further firing over the area will be on order of the leader.

(2) *Flanks invisible.* If the flanks of the targets are invisible to the gunner, the leader will indicate their locations and the point at which each gun will fire its initial burst, either by firing one gun, by laying the gun, by firing a rifle, or by use of a reference point. When the locations of the flanks or the reference point, which may be the aiming point, have been announced, the procedure to cover the area is as indicated in (1) above.

c. **BY PLATOON, USING HEAVY GUN.** A platoon uses the same method as the section, each section engaging the target as if it were acting alone.

## Section VIII. FIRE CONTROL

### 179. General

Fire control of machine guns includes all operations connected with the preparation and actual application of fire to a target. It implies the ability of the leader to open fire at the instant he desires, adjust the fire of his guns upon the target, regulate the rate of fire, shift fire from one target to another, and cease firing. Ability to exercise proper fire control depends primarily on the discipline and correct technical training of the gun crew. Failure to exercise proper fire control results in danger to friendly troops, loss of surprise effect, premature disclosure of position, misapplication of fire on unimportant targets, loss of time in securing adjustment, and waste of ammunition.

### 180. Chain of Fire Control

a. **COMPANY COMMANDER.** The company commander's field order assigns a mission to each platoon, or gives the firing position area each platoon will occupy, the targets it will engage or the sector of fire it will cover, and the location of friendly troops in the vicinity. Instructions may be included for the opening of fire and the rate of fire. He gives his orders orally and directly to the platoon leaders or transmits written orders to them by messengers. These are tactical orders which rarely prescribe the technique to be employed in carrying them out. The actual control of fire is left to the platoon leaders.

b. **PLATOON LEADER.** Usually, the platoon leaders give their instructions orally and directly to the section leaders. These orders assign a mission to each section, or give the firing position area each section will occupy and the targets it will engage, or the sector of fire it will cover and the exact location of friendly troops that may be endangered by the fire of this platoon. Frequently, the technique to be employed in engaging targets will be prescribed. Section leaders may be assembled for this purpose, or the platoon leader may go to the section leaders and give



them individual orders. If the sections are widely separated, as they may be in a defensive situation, it may be necessary for the platoon leader to send written instructions to section leaders. He will rarely be able to issue orders orally to his entire platoon, especially if fire has already been opened.

*c. SECTION LEADER.* The section leader is responsible for both the tactical and technical employment of his section. It is his responsibility to pass on to his squads the information received from the platoon leader as to the firing position area, targets to be engaged, sector of fire, friendly troops that may be endangered by fire of the section, and fire adjustment of the section.

*d. SQUAD LEADER.* The squad leader carries out the instructions of the section leader. He is responsible for fire control and fire discipline within his squad.

### 181. Application of Fire

*a. TIME OF OPENING FIRE.* It is often of great importance that machine gun fire be withheld until it will have maximum effect, and that all guns open fire at the same instant. To insure this, the leader may preface the command or signal for commencing fire by the words "Upon signal" or "At my command," depending on which method he desires to use. Either method permits him to check all guns to see that they are properly laid, or, in case of overhead fire, that there is sufficient clearance, and enables him to hold the fire until the critical moment. If fire is to be opened immediately, the command COMMENCE FIRING is announced immediately after the other elements of the order. Gunners then will open fire individually as soon as guns are laid.

*b. RATES OF FIRE.* The greatest surprise and shock effect is obtained by combining the maximum rate of fire with the simultaneous opening of fire of all guns for at least the first few bursts. Fleeting targets should always be engaged as soon as possible, and with the maximum fire available. The initial delivery of fire using the rapid rate facilitates adjustment of fire. When the rate of fire is not specified, the rapid rate will be used. In all cases, unless otherwise ordered, the first few bursts will be at the rapid rate; thereafter, the prescribed rate will be used. The following are the prescribed rates:

(1) *Heavy machine gun.* (a) *Slow*, approximately one-quarter belt (60 to 65 rounds) per minute, fired in 10 bursts of from 6 to 8 rounds each. Command: SLOW.

(b) *Medium*, approximately one-half belt (125 rounds) per minute, fired in 15 bursts of from 8 to 10 rounds each. Command: MEDIUM.

(c) *Rapid*, approximately one belt (250 rounds) per minute, fired in 15 bursts of from 15 to 20 rounds each. Command: RAPID.

(2) *Light machine guns.* (a) *Slow*, approximately 40 rounds per minute, fired in 7 bursts of 6 rounds each. Command: SLOW.

(b) *Medium*, approximately 75 rounds per minute, fired in 10 bursts of from 6 to 8 rounds each. Command: MEDIUM.

(c) *Rapid*, approximately 150 rounds per minute, fired in 15 bursts of from 8 to 10 rounds each. Command: RAPID.

c. ADJUSTMENT OF FIRE. (1) *Methods.* Fire is adjusted by the following methods:

(a) By observation of strike.

(b) By observation of tracers.

(c) By frequently relaying or checking the aim.

(2) *Corrections and adjustments.* Observation and adjustment of fire is the most important element of fire control. It must be continuous throughout the action. The gunner should be trained to anticipate the action of the enemy after fire is opened, and shift his fire to cover any changes in the formation or location of his target. Responsibility for adjustment of fire rests with the gunner on up to the platoon leader.

(a) *Using guns on tripod.* Corrections are announced or signaled as, "Up," "Down," "Right," or "Left," so many mils. Small changes in elevation and direction, such as "Up 5" or "Right 2," are set off by the elevating and traversing handwheels. Large range corrections are made by announcing or signaling a new range. Signals are as prescribed in FM 22-5.

(b) *Using light gun on bipod.* Corrections are announced or signaled as "Up," "Down," "Right," or "Left," so many yards. Large corrections in elevation should be made by announcing or signaling a new range to be placed on the sight leaf.

## Section IX. AUXILIARY AIMING POINT

### 182. General (fig. 110)

When the target is invisible to the gunner or is exceptionally difficult to see, fire may often be directed by use of an auxiliary aiming point, securing data by one of the two methods given below.

a. BINOCULAR METHOD. The leader selects a clearly defined object in the vicinity of the target. Using the inverted sight leaf, he aligns on the target that graduation which corresponds with the range to the target. Keeping the binoculars in that position, he reads the graduation

on the scale opposite the auxiliary aiming point. If the auxiliary aiming point is not on the line gun-target, the deflection may be read on the horizontal mil scale of the binocular. Using these readings as the sight setting and deflection, for example, range 1,350, sight right 20 (fig. 110) the gunner lays on the object selected as the auxiliary aiming point and fires, distributing the fire as ordered by the unit leader.

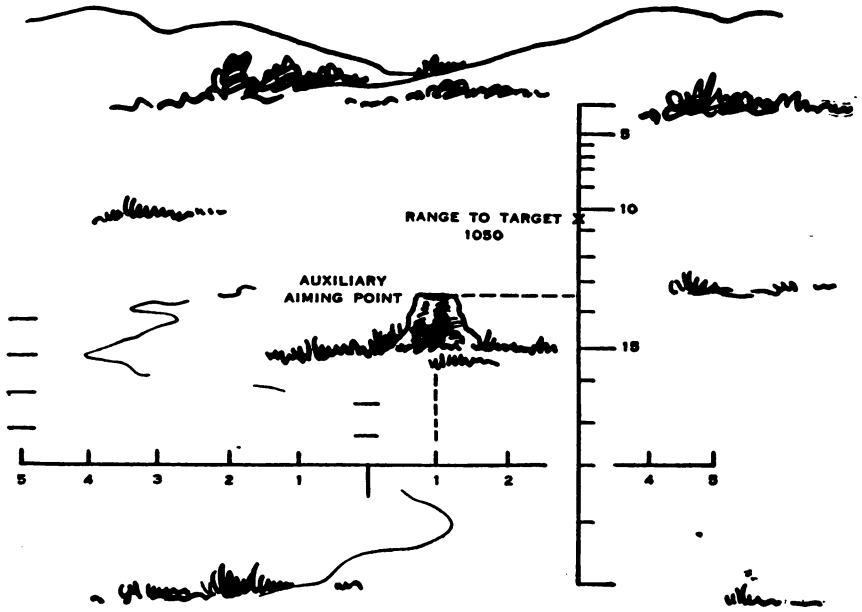


Figure 110. View through binocular; use of auxiliary aiming point.

**b. GUN METHOD.** Data for auxiliary aiming points may be determined by means of the rear sight slide and windage scale on the gun. The gun is first laid on the target with the correct sight setting to hit the target, and when the tactical situation permits, the initial laying is verified by firing. Then, without disturbing the laying of the gun, the rear sight is manipulated so that the line of aim is directed at some clearly defined object (stump, bush, aiming stake) which the gunner will always be able to see, no matter what the conditions of visibility may be. The settings on the rear sight and the windage gauge are recorded. Then, when fire is to be placed on the target, the leader announces these settings in his fire order and directs the gunner to lay on the auxiliary aiming point. Example command: RANGE 1,350; SIGHT RIGHT 20; FRONT AT A DISTANCE OF 300 YARDS, DEAD STUMP; AIMING POINT; FIXED.

## Section X. FIRE ORDERS

### 183. Fire Orders

For a description of the various elements of fire orders, see sections V, VI, VII, and VIII of this chapter.

*a.* **TARGET DESIGNATION ELEMENT.** The target designation element includes the following information as to the target:

- (1) Range.
- (2) Direction.
- (3) Description of the target.

This information will always be given in the sequence listed above. Although the target designation element may be conveyed by different methods, as described in paragraph 172, each method includes the information listed above. For example, the target designation element of a fire order might be given orally as follows:

RANGE 900.  
RIGHT FRONT.  
SKIRMISH LINE.

*b.* **FIRE DISTRIBUTION ELEMENT.** This element (par. 173) gives the necessary data to insure delivery of effective fire over the entire target. It specifies the manner by which the firing unit concerned engages point targets, wide targets, deep targets, oblique targets, area targets, and indistinct targets. The fire distribution element includes, in the sequence listed, instructions for such of the following as are required:

- (1) Subdivision of the target.
- (2) Type of distribution (manipulation).

For example, the fire distribution element of a fire order might be given orally as follows:

1ST SECTION, RIGHT HALF.  
2D SECTION, LEFT HALF.  
TRAVERSE.

*c.* **FIRE CONTROL ELEMENT.** (1) This element (par. 179) includes the data for insuring, when necessary, safety to friendly troops; proper, timely fire; density; surprise; fire adjustment; and cessation of fire. The fire control element gives, in the sequence listed, data for such of the following as are required:

- Overhead fire.
- Rate of fire.
- Instructions for opening fire.
- Adjustment corrections.
- Command or signal to cease firing.

(2) Any specific part of the fire control element which does not apply may be omitted. For example, the fire control element of a fire order might be given as follows:

RAPID.

AT MY COMMAND.

COMMENCE FIRING.

#### 184. Examples of Fire Orders

##### a. EXAMPLES.

(1) RANGE 1,000.  
COMMENCE FIRING.

(2) RANGE 900.  
LEFT FRONT.  
ANTITANK GUN.  
COMMENCE FIRING.

b. EXAMPLE OF LENGTHY ORDER. (An order of this length would be very unusual in the field.)

RANGE 1,100.  
SIGHT LEFT 5.  
RIGHT FRONT.  
REFERENCE: LONE PINE.  
TO LEFT, SMALL OAK.  
LEFT 20 MILS.  
CORNER OF DITCH.  
TARGET: MACHINE GUN.  
FIXED.  
RAPID.  
AT MY COMMAND.  
COMMENCE FIRING.

c. ORDERS FOR WIDE TARGETS. (1) When the target is not wide enough to necessitate subdivision and is to be engaged by a section.

(a) RANGE 1,000.  
RIGHT FRONT.  
SKIRMISH LINE FROM DEAD TREE RIGHT TO  
CLEARING.  
TRAVERSE.  
MEDIUM.  
UPON SIGNAL.

(Signal for commence firing.)

(b) RANGE 900.  
WATCH MY BURSTS (OR TRACERS)  
(Section leader lays and fires gun at left flank.)  
LEFT FLANK.

(Section leader lays and fires gun at right flank.)  
RIGHT FLANK.  
SKIRMISH LINE.  
TRAVERSE.  
MEDIUM.  
COMMENCE FIRING.

(c) RANGE 1,200.

FRONT.  
REFERENCE: LONE TREE.  
TARGET: SKIRMISH LINE EXTENDING RIGHT 20  
MILS AND LEFT 30 MILS.  
TRAVERSE.  
RAPID.  
AT MY COMMAND.  
COMMENCE FIRING.

(2) When the target is wide enough to necessitate subdividing and is to be engaged by a section.

RANGE 800.  
RIGHT FRONT.  
SKIRMISH LINE FROM GREEN TREE RIGHT TO  
HEDGE ROW.  
NO. 1, RIGHT THIRD.  
NO. 2, LEFT TWO-THIRDS.  
RAPID.  
COMMENCE FIRING.

When the target is dense and moving rapidly toward the section (platoon in the case of the heavy gun) or is at a short range.

LEFT FRONT.  
SWINGING TRAVERSE.  
COMMENCE FIRING.

d. ORDER FOR POINT TARGET. When the target has width and depth no greater than the beaten zone and is to be engaged by section (or platoon in the case of the heavy gun) the order may be given as follows:

RANGE 1,000.  
FRONT.  
MACHINE GUN.  
FIXED.  
RAPID.  
UPON SIGNAL.

(Signal for commence firing.)

e. ORDERS FOR DEEP TARGETS. (1) When the target is less than 200

yards in depth and is to be engaged by section (or platoon in the case of the heavy gun).

RANGE 900.  
FRONT.  
COLUMN.  
SEARCH.  
RAPID.  
COMMENCE FIRING.

- (2) When the ends of the target are not visible to the gunners.

RANGE 800.  
RIGHT FRONT.  
REFERENCE: LONE BUSH.  
TARGET: TRENCH EXTENDING SHORT 2 MILS  
(SHORT 100 YARDS in case of M1919A6 gun on  
bipod) and OVER 4 MILS (OVER 200 YARDS in case  
of M1919A6 gun on bipod).  
SEARCH.  
MEDIUM.  
COMMENCE FIRING.

- (3) When the target is 200 yards or more in depth and is to be engaged by section.

NO. 1, 900.  
NO. 2, 1,200.  
LEFT FRONT.  
RIGHT EDGE OF WOODS.  
SEARCH.  
RAPID.  
COMMENCE FIRING.

- (4) When the target is moving rapidly away from or toward the guns:

RANGE 500.  
ALL GUNS ON FAR (NEAR) END, SEARCH.  
RAPID.  
AT MY COMMAND.  
COMMENCE FIRING.

f. ORDERS FOR OBLIQUE TARGETS. (1) When the target is not wide enough to necessitate subdivision, has more depth than the beaten zone, but less than 200 yards, and is to be engaged by a section.

RANGE 900.  
RIGHT FRONT  
RIFLEMEN IN EDGE OF ORCHARD

TRAVERSE AND SEARCH.  
MEDIUM.  
COMMENCE FIRING.

(2) When the target measures less than 100 mils in width, has more depth than the beaten zone, but less than 200 yards, and is to be engaged by a platoon. (This fire order applies to the heavy gun only.)

BOTH SECTIONS.

RANGE 1,000.

FRONT.

PATROL TO THE RIGHT OF RED BANK.

TRAVERSE AND SEARCH.

MEDIUM.

COMMENCE FIRING.

(3) When the target is wide enough to necessitate subdividing, has a depth of 200 yards or greater, and is to be engaged by section or platoon (heavy gun).

NO. 1 (and 3 if platoon of heavy guns are engaging the target)  
900.

NO. 2 (and 4 if platoon of heavy guns are engaging the target)  
1,300.

FRONT.

SKIRMISH LINE EXTENDING FROM EDGE OF  
WOODS RIGHT TO RAIL FENCE.

NO. 1 (and 3), RIGHT HALF.

NO. 2 (and 4), LEFT HALF.

TRAVERSE AND SEARCH.

RAPID.

COMMENCE FIRING.

*g.* ORDERS FOR AREA TARGETS. When the area measures less than 100 mils in width (heavy gun) or less than 50 mils in width (light guns), and is to be engaged by a section. (If there is no reference point along the near or far edge of the target, the leader must lay the guns for the initial burst and complete the fire order orally.)

(1) RANGE 1,300.

FRONT.

AREA: GREEN PATCH.

TRAVERSE.

SEARCH UP 3.

MEDIUM.

COMMENCE FIRING.

(2) RANGE 1,200.

FRONT.



REFERENCE: BLACK STUMP.  
TARGET: AREA EXTENDING RIGHT 20 MILS AND  
LEFT 30 MILS.  
TRAVERSE.  
SEARCH DOWN 3.  
MEDIUM.  
COMMENCE FIRING.

*h.* ORDERS REQUIRING USE OF AN AUXILIARY AIMING POINT.

RANGE 1,000, SIGHT RIGHT 8.  
RIGHT FRONT AT DISTANCE OF 600 YARDS, BLACK  
STUMP.  
AIMING POINT.  
FIXED.  
RAPID.  
COMMENCE FIRING.

*i.* ORDERS REQUIRING OVERHEAD FIRE. (1) When the range is 900  
yards or less.

RANGE 850.  
LEFT FRONT.  
RIFLEMEN ALONG CREST OF SMALL KNOLL.  
TRAVERSE.  
OVERHEAD.  
TROOPS IN DITCH TO FRONT.  
TEST FOR SAFETY.  
(Gunner reports.)  
MEDIUM.  
COMMENCE FIRING.

(2) When the range is greater than 900 yards.

RANGE 1,200.  
FRONT.  
SKIRMISH LINE ALONG EDGE OF WOODS.  
TRAVERSE.  
OVERHEAD.  
TROOPS IN DRAW TO FRONT.  
SAFETY LIMIT, THAT LINE OF SCRUB BRUSH.  
RAPID.  
COMMENCE FIRING.

*j.* ORDERS REQUIRING FIRE TO DETERMINE RANGE.

NO. 1, 900.  
SIGHT RIGHT 3.  
FRONT.  
POINT WHERE ROAD ENTERS WOODS.

ADJUST.  
 COMMENCE FIRING.  
 (Gunner reports.)  
 ALL GUNS, 975.  
 EDGE OF WOODS.  
 TRAVERSE.  
 MEDIUM.  
 COMMENCE FIRING.

## Section XI. OVERHEAD FIRE

### 185. General

a. Overhead fire is fire delivered over the heads of friendly troops. A machine gun on a tripod is capable of delivering this type of fire because of the small and uniform dispersion of the cone of fire. In the attack, the use of overhead fire permits the machine gun to support the advance of rifle units.

*Note.* Overhead fire will not be delivered by the M1919A6 gun when mounted on the bipod, unless the vertical interval of the troops below the line gun-target is such as to make safety obvious.

b. MEANS OF DELIVERING. Overhead fire may be delivered by either direct or indirect laying methods. This section will deal solely with overhead fire delivered by direct laying methods. For indirect laying methods, see chapter 8.

c. MINIMUM CLEARANCE (fig. 111). The center of the cone of fire must clear the feet of the friendly troops by a prescribed distance. This distance, known as minimum clearance, is found by adding together the following elements:

- (1) The height of a man standing, taken as 2 yards.
- (2) Half the vertical dimension of the 100 percent cone of fire at the range to the troops.
- (3) A margin of safety equal to the vertical distance which subtends a 5-mil angle at the gun, or 10 feet, whichever is greater.

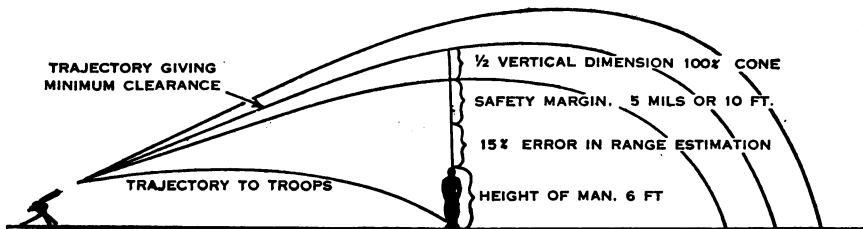


Figure 111. Components of minimum clearance.

(4) An additional allowance to compensate for a 15 percent error in range determination.

d. **SAFETY ANGLES.** In order to obtain this minimum clearance, the gun must be elevated so that the center of the cone of fire is raised from the feet of the friendly troops, to minimum clearance above their feet. The amount of elevation change required to give this minimum clearance is known as the *safety angle*, and is the difference between the angle of elevation to hit the troops and the angle of elevation for troop safety. (See par. 2, table II, app. V.)

### 186. Overhead Fire

a. **RULES.** (1) *Corresponding range on level or uniformly sloping ground.* When the gun is fired from the tripod with the required safety angle, the point where the center of impact strikes the ground determines the shortest range at which fire can be delivered over the heads of friendly troops. The range from the gun to the point of strike is called the corresponding range. When the ground is level or uniformly sloping between the gun and target, the corresponding range for the safety angle used is obtained by converting the troop safety angle, which is expressed in mils, into range. *Example:* The troop safety angle for troops at a range of 1,000 yards is 35 mils (par. 2, table II, app. V), this example being based on data for M2 ball ammunition. In table I the range for 35 mils is 1,500 yards, which is the corresponding range when troops are 1,000 yards in front of the gun. Thus, no target at a closer range than 1,500 yards can be engaged over level or uniformly sloping ground when the troops are 1,000 yards from the gun.

(2) *Uneven terrain.* Level or uniformly sloping ground between the gun and target will seldom be found in the field. This precludes the use of firing tables to determine the corresponding range and consequently the exact point on the ground where the corresponding range terminates. In lieu of firing tables, two rules of thumb, the gunner's rule and the leader's rule, have been devised by means of which the required safety angle may be set on the gun with the rear sight, on any terrain, *provided the feet of the friendly troops are on or below the line, gun-target.* The safety angle having been automatically set on the rear sight, the corresponding range is determined by the intersection of the line of aim with the ground.

b. **GUNNER'S RULE** (fig. 112). The gunner's rule is used to determine the safety angle when the range to the target is 900 yards or less. It is applied by the gunner unless the safety limit has been determined and announced by the platoon or section leader. The rule is as follows:

(1) Lay the gun on the target with the correct sight setting to hit the target.

(2) Without disturbing the lay of the gun, set the rear sight at 1,500 yards.

(3) Look through the sights and note the point where this new line of aim strikes the ground. This point is the safety limit. If this point is beyond the feet of the friendly troops, overhead fire can be delivered safely until the troops reach this point. It is not safe to fire when the friendly troops pass this point.

(4) Gunners report "safe" or "not clear" to indicate whether or not it is safe to fire.

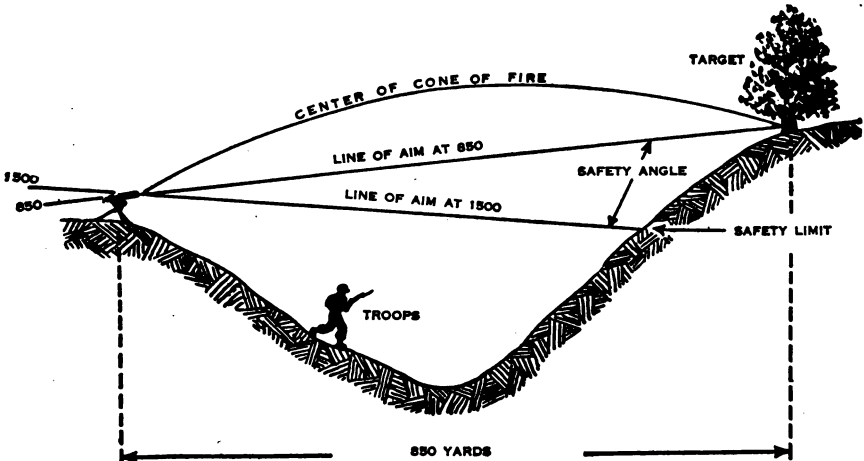


Figure 112. Application of gunner's rule.

c. LEADER'S RULE (fig. 113). The leader's rule is used by the platoon or section leader only in case the range to the target is greater than 900 yards. The rule is as follows:

(1) Select a point on the ground to which it is believed friendly troops can advance with safety.

(2) Determine the range to this point by the most accurate means available.

(3) Lay the gun on the target with the correct sight setting to hit the target.

(4) Without disturbing the lay of the gun, set the rear sight at 1,500 yards, or the range to the selected point plus 500 yards, (plus 600 yards when firing the M1919A4 gun), whichever is greater. *Under no conditions should the sight setting be less than 1,500 yards.*

(5) Note the point where the new line of aim strikes the ground.

(a) If it strikes at the selected point, that point marks the limit of safety.

(b) If it strikes short of the selected point, it is safe for troops to

advance to the point where the line of aim strikes the ground, and to an unknown point beyond. If it is desired to fire after friendly troops advance farther than the point where the line of aim strikes the ground, this farther point must be determined by testing new selected points until the line of aim and the selected point coincide.

(c) If it clears the selected point, it is safe for the troops to advance to the selected point, and to an unknown point beyond. If it is desired to have troops advance beyond the selected point, this further point must be determined by testing new selected points until the line of aim and the selected point coincide. This point marks the limit of safety.

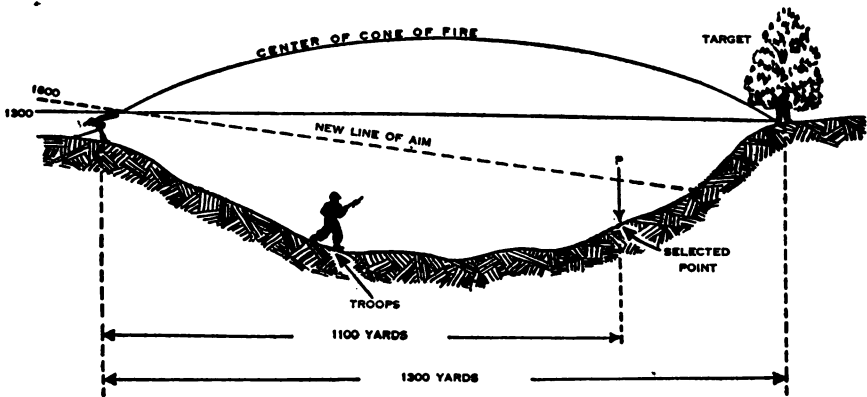


Figure 113. Application of leader's rule.

(6) Procedure before friendly troops reach the limit of safety. (a) Safety limit identified on the ground. The safety limit having been determined, the gunners and all leaders must note some terrain feature by means of which the limit may be identified on the ground. In case safety has been determined by the platoon or section leader, the limit of safety is announced so that the gunners and squad leaders are able to identify it. If necessary, the limit is indicated with the rear sight of each gun, care being taken not to change the laying of the gun on the target.

(b) Report by gunners. In case the gunner's rule is applied, gunners report "safe" or "not clear" to indicate whether or not it is safe to fire.

(c) Checking laying while firing. After determining or noting the safety limit, the gunner moves the sight back to the range to the target in order, while firing, to check the laying on the target.

d. PROCEDURE AFTER FRIENDLY TROOPS REACH LIMIT OF SAFETY. When the friendly troops reach the safety limit, firing ceases.

e. **USE OF BINOCULAR IN APPLYING SAFETY RULES.** It is frequently desirable to determine safety for overhead fire before guns are placed in position. Safety may be approximately determined by means of the inverted sight leaf in the binocular. The gunner's and leader's rules are applied with the inverted sight leaf in the binocular in a manner similar to that with the rear sight on the gun. After the guns are emplaced, safety should be checked with the gun sights.

f. **TROOP SAFETY ZONES ON LEVEL OR UNIFORMLY SLOPING GROUND (M1917A1 GUN).** At times it may be imperative to deliver overhead fire, if actual safety does exist, even though the gunner's or the leader's rule indicates that it is not safe to fire. Such conditions will usually obtain only when the target is at a long range, and the guns, troops, and target are at about the same elevation. To cover such cases, the following table of troop safety zones have been computed. It will always be safe to deliver overhead fire by direct laying at ranges indicated if the troops are within the limits shown, unless they are above the line gun-target, when it will not be possible to use direct laying. *All ranges must be accurately determined.*

### TROOP SAFETY ZONES

Range to target (yards)	Troops are safe from—
1,300 .....	500 to 700 yards
1,400 .....	400 to 800 yards
1,500 .....	300 to 1,000 yards
1,600 .....	300 to 1,100 yards
1,700 .....	200 to 1,200 yards
1,800 .....	200 to 1,300 yards
1,900 .....	200 to 1,400 yards
2,000 .....	200 to 1,500 yards

g. **PRECAUTIONS FOR OVERHEAD FIRE.** The following additional precautions will always be observed when overhead fire is used:

(1) Except when time and facilities in combat do not permit, depression stops are used to prevent the muzzle of the gun from being accidentally lowered below the limit of safety.

(2) If safety has been checked only by application of the leader's or gunner's rule, overhead fire will not be delivered if the troops are less than 400 or more than 1,800 yards from the guns, unless the vertical interval of the troops below the line gun-target is such as to make safety obvious.

(3) Since the trajectories of tracer ammunition beyond 750 yards are unpredictable, it will not be used for overhead fire.

(4) Overhead fire will not be delivered through woods which are likely to deflect bullets into friendly troops.

(5) Commanders of friendly troops are informed when fire is to be directed over them, except when impracticable in combat.

(6) A barrel that has fired 5,000 rounds or which gives evidence of excessive muzzle blast will not be used for overhead fire.

*h. ADDITIONAL SAFETY PRECAUTIONS FOR HEAVY GUN.* (1) The tripod will be firmly mounted, with jamming handles and cradle clamping handle tight; badly worn tripods will not be used.

(2) The water jacket will be kept filled; guns will not be allowed to heat excessively.

*i. ADDITIONAL SAFETY PRECAUTIONS FOR LIGHT GUNS (ON TRIPODS).*

(1) The tripod will be firmly mounted.

(2) The rate of fire will not exceed the medium rate.

(3) Any barrel which has fired 750 consecutive rounds will be allowed to cool, or the barrel changed, before overhead fire is delivered.

(4) Single shot fire is habitual. The size of the strings of shots employed should follow the general rule: Number of shots in the string equals the number of hundreds of yards in range.

## Section XII. FINAL PROTECTIVE LINES

### 187. Definition

A final protective line (FPL) is a predetermined line along which grazing fire will be placed to stop an enemy assault. The fire is usually fixed as to direction and elevation and is capable of being delivered under all conditions of visibility. When fixed fire is incapable of producing the maximum effective grazing fire, because of irregularities in the terrain, some searching fire may be employed in conjunction with the fire of other weapons, in order to insure that all of the FPL will be covered.

### 188. Sectors of Fire

Machine guns located to defend the main line of resistance are assigned sectors of fire, the inner limits of which are usually, but not always, the bands of grazing fire placed along the FPL. The machine gun fire unit is responsible for engaging the enemy within its sector, subjecting him to fire as he approaches, and finally forcing him to pass through coordinated bands of grazing fire before he can deliver his assault. If the sector of fire does not include an FPL, a zero line is used. It is desirable that the zero line approximately bisect the sector, and that it point toward a clearly defined landmark in the area.

## 189. Influence of Terrain

On level or uniformly sloping ground up to a range of 750 yards, the center of the cone of fire does not rise above the height of a standing man. The length of the forward half of the beaten zone is added to the range, 750 yards, in computing the total possible danger space on level or uniformly sloping ground as approximately 800 yards. However, level ground or ground that slopes uniformly for 750 yards is not often available. Two cases are given in the following paragraph to illustrate the different types of terrain on which FPL's may be placed and the methods of laying the gun for elevation and direction in order to get the maximum amount of grazing fire in each case.

## 190. Methods of Laying on Final Protective Lines (fig. 114)

a. LEVEL OR UNIFORMLY SLOPING GROUND. (1) *Heavy gun.* (a) *Direction.* The gunner lays the gun in the direction of the FPL or zero line and zeros the dial.

(b) *Elevation.* The gunner selects an aiming point on the FPL or zero line at a range of approximately 750 yards. No. 2 measures the angle of quadrant elevation by means of a clinometer.

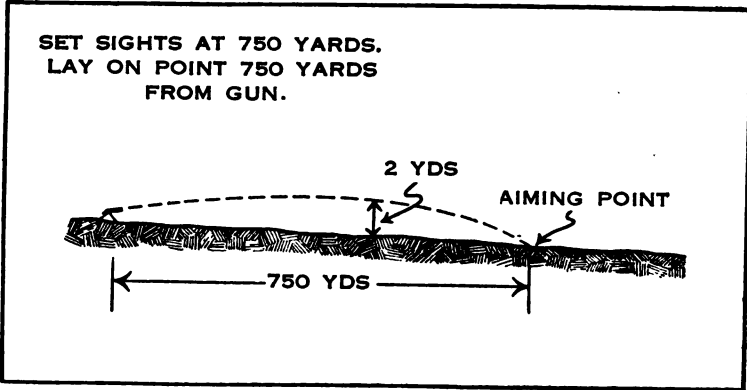
(2) *Light guns on tripod.* (a) *Direction.* The gunner centers the traversing handwheel mechanism and zeros the traversing micrometer. Upon determining along which limit of the sector the FPL is to lie, the gunner sets the traversing slide toward that end of the traversing bar which is opposite to the direction of the FPL; he then lifts the rear legs of the tripod and aligns the muzzle in the approximate direction of the line. By so doing he obtains the maximum angle of traverse away from the FPL in the direction of the targets in his sector. (Observe that directional laying of the gun to the left requires that the traversing slide be set to the right of the zero mark on the traversing bar, and vice versa. For all readings of the traversing bar scale, the left edge of the traversing slide is used as an index.) If a zero line is used instead of a final protective line, the gunner centers the traversing slide at zero on the traversing bar scale; he then lifts the rear legs of the tripod and aligns the gun on the designated line. The traversing bar reading of zero is indicated on the range card.

(b) *Elevation.* The gunner lays the gun on an aiming point as in (1) (b) above. He notes the sign and the first number whose graduation is visible above the elevating handwheel on the elevating screw scale, then obtains the number on the elevating micrometer dial toward which the indicator is pointing. A combination of these numbers when replaced on the gun will allow the gun to be laid for the same elevation.

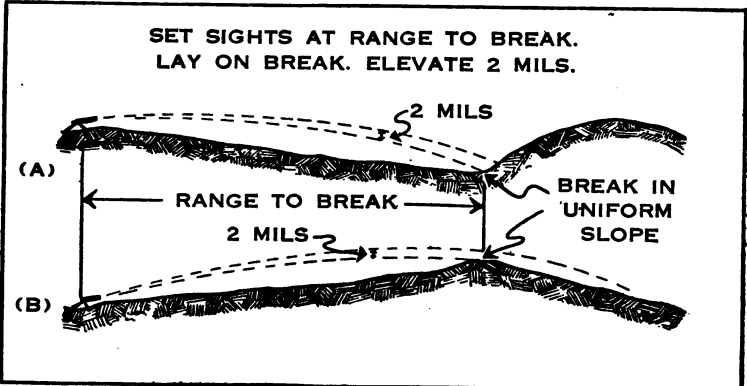
b. IRREGULARLY SLOPING GROUND. (1) *Direction.* The gunner lays



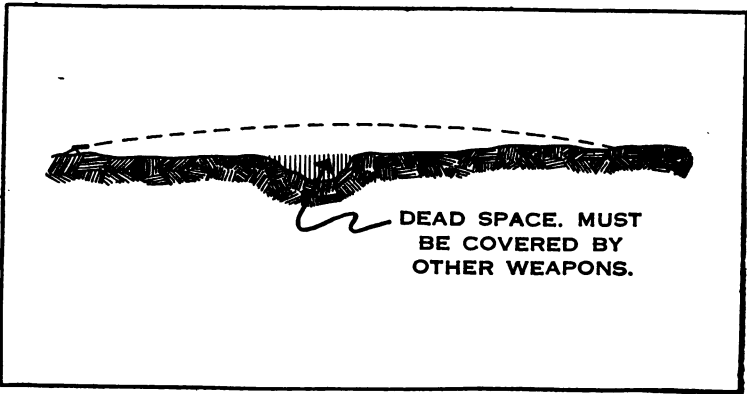
the gun by sighting in the desired direction, as described in (1) (a) and (2) (a) above.



① Method of laying when the ground is level or uniformly sloping.



② Method of laying when there is a break in the uniform slope—  
for ranges less than 750 yards.



③ Dead space.

Figure 114. Final protective lines.

(2) *Elevation.* The gunner selects an aiming point on the ground and near the break in the uniform slope, and, with a sight setting of the range to the selected point, lays the gun on that point and elevates it 2 mils by means of the elevating handwheel. (See fig. 114②.) Depressions in the final protective line must be covered by other weapons. (See fig. 114③.)

### 191. Methods of Laying Gun for Firing During Conditions of Poor Visibility

*a. GENERAL.* Prior to firing under conditions of poor visibility, the gun is laid on its FPL during a period of good visibility, and necessary data obtained and recorded. The procedure to obtain this data and to lay the gun is as follows:

*b. AIMING STAKE METHOD.* The gun having been laid for elevation and direction, by the methods described in paragraph 190, zero the windage gauge. Raise the rear sight to maximum elevation, and, without disturbing the lay of the gun, line in an aiming stake to conform to the sight picture, and drive in the stake. The sight setting should be recorded on the range card. To lay the gun properly at any time, aim at the same point on the aiming stake as was used when placing the stake.

*c. CLINOMETER AND DIAL READING METHOD (HEAVY GUN).* The data obtained as described in paragraph 190*a*(1) is placed on the gun, which may then be fired accurately regardless of visibility. While this method is more accurate than the aiming stake method, the slightest disturbance of the tripod will throw the gun off.

*d. TRAVERSING BAR AND ELEVATING SCREW READING METHOD (LIGHT GUNS).* The data obtained as described in paragraph 190*a*(2) is placed on the gun. The same precautions as to not disturbing the tripod must be observed as in *c* above.

*e. AUXILIARY AIMING POINT METHOD.* See section IX.

### 192. Rates of Fire on Final Protective Line

*a. GOOD VISIBILITY.* Fire on the FPL during periods of good visibility is aimed and adjusted fire. Under such conditions, the section leader will generally determine the rate of fire and may also give the order to cease firing.

*b. POOR VISIBILITY.* Under conditions of poor visibility, the battalion order may prescribe the rates of fire. In the absence of instructions, the usual rate of fire for a section on an FPL is the rapid rate for the first 2 minutes and the medium rate until ordered to cease firing. The section rate of fire may be maintained by one gun, or by both guns, firing alternating bursts.

### 193. Habitual Laying on Final Protective Line

Except when other targets are being engaged, the gun is habitually laid on the FPL.

## Section XIII. RANGE CARDS

### 194. Range Cards

*a. GENERAL.* (1) In order to be prepared to deliver fire promptly on likely targets in any situation, data which will facilitate the laying of the guns during hours of both good and limited visibility must be determined. These data must be determined to all keypoints at or near which targets may be expected, such as crossroads, ridges, stream junctions, woods, and other landmarks. The targets may include areas which may be occupied by the enemy. The data must also be recorded in a form which will serve as a guide to the leaders and gun crew. A range card for each gun is used for this purpose. It is in the form of a sketch of the sector, showing only the probable locations of targets and the data as to direction and range or elevations necessary to place fire on them.

(2) The employment of range cards allows decentralization of command without loss of fire control. This advantage is especially true in highly organized defensive positions where guns may be widely separated. Range cards are also of great value in planning the coordination of defensive fires. Duplicates of the original range cards prepared during the occupation or consolidation of a newly occupied position are collected by platoon leaders. With the addition of such brief explanatory remarks as may be necessary, these reports are sent back to the company commander. Such reports show exactly what the guns can do and indicate where coordination and rearrangement are necessary.

*b. PREPARATION OF RANGE CARDS.* (1) Range cards should be prepared immediately upon occupation of defensive positions and copies sent to the next higher commander. The range cards form a record for use by the relieving gun crews and are always considered as part of the orders for a position. Range cards should be prepared as soon as possible for all positions, including alternate and supplementary positions.

(2) In preparing range cards, the following items should be taken as guides:

(*a*) Notation should be made on the card of the designation of the squad, platoon, and company, of the accurate location of the gun position, and of the date of occupation.

(*b*) A north, south, east, or west line is drawn to permit orientation of the card.

(c) All data and instructions should be legibly printed.

(d) Landmarks or targets should be indicated by conventional signs or sketches in perspective, naming them where necessary to prevent misunderstanding.

(e) Targets should be numbered from left to right.

(f) The final protective line which usually forms one limit of the sector of fire should be taken as a base line with a dial setting of zero. That part of the line which provides fixed grazing fire should be shown in heavy black.

(g) The directions to all targets should be indicated by the proper dial settings and the elevations by the proper sight settings and quadrant elevations. (See (3) below.)

(3) The final protective line should be taken as a base line to which the directions of all other targets are referred. With the gun established on its final protective line, the dial is zeroed. The gun is then laid successively to hit points or areas selected as probable targets; the dial reading and the quadrant angle of elevation for each are recorded on the range card. If the target has width, the dial settings for both flanks are recorded. If it is desired to search an area, the direction and amount of search must be written on the card. When the card is used in directing fire against any particular target, the dial reading and the quadrant angle of elevation may be announced, for example, "Dial 5,820, QE plus 58," or the target number only may be announced.

(4) Figure 115 is an example of a range card for use in defense.

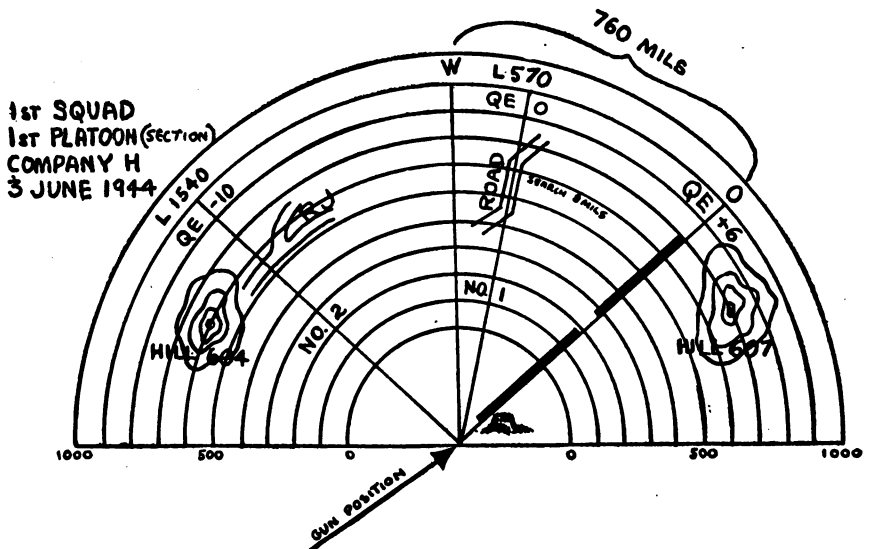


Figure 115. Range card, M1917A1 gun.

## **Section XIV. DIRECT LAYING ON LANDSCAPE TARGETS AT 1,000 INCHES**

### **195. General**

Most phases of the technique of direct laying can be taught on landscape targets at 1,000 inches. Their use makes possible the teaching of direct laying indoors when conditions are unfavorable for outdoor work or where the lack of terrain precludes field firing. Instruction may be given by using caliber .22 ammunition. This type of instruction should precede direct laying problems in the field but should never entirely replace field firing. Problems should be fired by section.

### **196. Targets**

The targets used are the standard series A landscape targets issued by the Ordnance Department. Instructions for constructing a landscape target setup are contained in FM 23-5. Traced reproductions of selected targets may be prepared and fastened over the corresponding target on the panel before each section fires; thus it is possible to use the target many times.

### **197. Mounting Guns**

The heavy guns are placed at intervals of approximately 3 yards, measured between pintles. The light guns on tripods are placed at intervals of from 3 to 5 yards depending upon the type of terrain into which the rounds are being fired. (See AR 750-10.)

### **198. Zeroing and Sight Setting**

The guns are zeroed as explained in paragraph 115, using a blank panel or any clear spaces on any of the panels. The guns, having been zeroed, may be aimed directly at the targets on the panel with the rear sights set at the zeroing graduation.

### **199. Ranges**

It is necessary to use an assumed range to complete the fire order. Small numbered cards, indicating hundreds of yards of range, are tacked along the outer edge of one of the flank panels. They should be spaced closer together for the longer ranges. Since the sights remain set at the zeroing graduation, the range announced in the fire order is used merely for the purpose of indicating to the gunners where to look for the target.

### **200. Direction**

The direction is announced as "Front," "Right (left) front," and "Right

(left) flank," indicating the center panel, the second from the right (left), and the right (left) panel, respectively.

### **201. Sectors of Fire and Final Protective Lines (FPL)**

Landscape targets are suitable for instruction in the preparation of data for defensive fires. For this instruction, a sector of fire, defined by terrain features, is first assigned to a section of guns, one limit of the sector usually being given as the direction of the FPL. Each squad leader is required to prepare a range card so that he may fire along the FPL, and on suitable targets within the sector, under all conditions of visibility. Guns are laid on the FPL using either method described in paragraph 190. The data for the FPL and other designated targets are then determined and recorded. As soon as this is completed, the guns are pointed away from the targets, the panels covered in any convenient way, and the section required to fire on the FPL and on the other targets.

## CHAPTER 7

### TECHNIQUE OF FIRE: POSITION DEFILADE

---

#### Section I. FIRING POSITIONS

#### 202. Position Defilade (fig. 116)

*a. GENERAL.* A gun is in position defilade when it is so sited that the gun and its crew are hidden from enemy ground observation and aimed small-arms fire from the target area by a crest or mask, but an observer standing at, or near, the gun can see the target and adjust the fire. The position may be on the reverse slope of the mask, on the forward slope of the next high ground in rear of the mask, or in a small fold in the ground. A defiladed firing position does not necessarily reduce the effectiveness of fire against a stationary enemy target nor preclude fire over the heads of friendly troops.

(1) *Advantages.* (a) The gun and crew have concealment and cover.

(b) The crew has some freedom of movement in the vicinity of the position.

(c) Control and supply are facilitated.

(d) The smoke and flash of the gun may not be readily apparent to the enemy.

(2) *Disadvantages.* (a) Rapidly moving targets are not easily engaged, because adjustment of fire is made by an observer.

(b) Targets at a relatively close range to the mask, and targets having a relatively large negative (minus) angle of site, usually cannot be engaged.

(3) *Characteristics.* (a) *Reverse slope position.* A reverse slope position has some protection from high-angle enemy fire when the gun is placed in minimum position defilade, and affords protection from enemy direct fire cannon. It may, however, be grazed by enemy machine gun fire. It is well concealed from observation by enemy personnel near the target area.

(b) *Forward slope position.* A forward slope position is not vulnerable to grazing fire from the target area. However, mortar and artillery fire are more effective against positions on this slope.

(c) *Maximum position defilade.* A gun is in maximum position defilade when sited in position defilade at the lowest point on a slope from which it can engage the target. It has relatively good cover but lacks flexibility in engaging new targets.

(d) *Minimum position defilade.* A gun is in minimum position defilade when sited at the highest point on a slope at which it will be in position defilade. It has great flexibility in engaging new targets, although it does not possess maximum cover.

b. **PARTIAL DEFILADE** (fig. 116②). A gun is in partial defilade when the gun and gunner have some protection by a mask from direct fire from the target area, and the gunner is able to engage the target by direct laying. Partial defilade is desirable whenever a fire mission cannot be accomplished from position defilade. A gun may be held in position defilade and moved into a partially defiladed position just prior to firing.

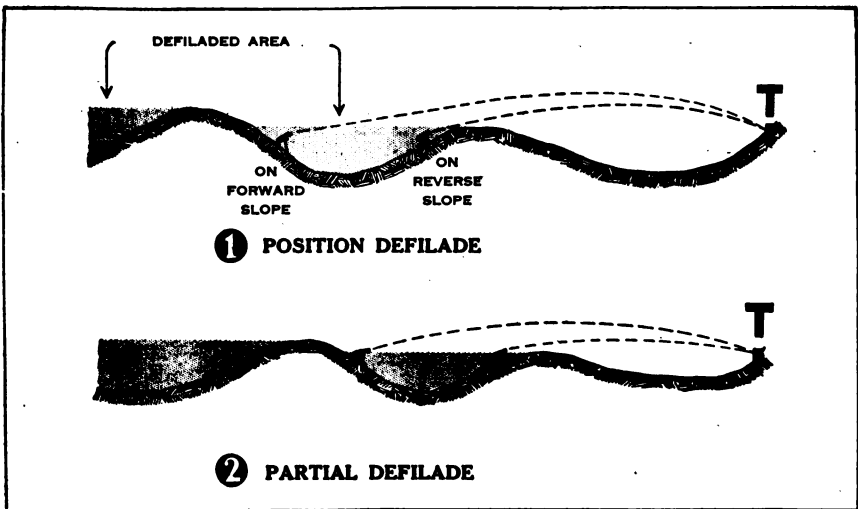


Figure 116. Defiladed firing positions.

### 203. Selecting Firing Position

a. The platoon or section leader indicates the approximate location of the gun. The squad leader selects the exact position.

b. To select a position in minimum position defilade, the squad leader, knowing the approximate height above the ground of the gunner's eyes when the gunner is in position behind the gun, moves up the slope until, sighting from that height, he has the target in view above the mask. He then moves down the slope, sighting from the same height, to the point at which the target is again masked. This point he marks as the



gun position. He may use a cleaning rod, on which the correct sighting height has been noted, as an aid in selecting the position and to mark the selected position.

c. While the squad leader selects the position, the gun crew examines equipment and mounts the gun under cover.

d. Upon signal from the squad leader, the gun is dragged to the selected firing position.

## Section II. FIRING

### 204. Essential Elements

The essential elements in the engagement of a target from position defilade are direction, elevation, mask clearance, and adjustment of fire.

### 205. Laying Gun for Direction

a. DIRECT ALIGNMENT METHOD. The observer posts himself on the line gun-target and in a position from which he can see the target. He aligns the gun approximately by having the gunner shift the tripod. The gunner then loosens the traversing clamp (traversing slide, M2 tripod) and, directed by the observer, moves the gun right or left until it is

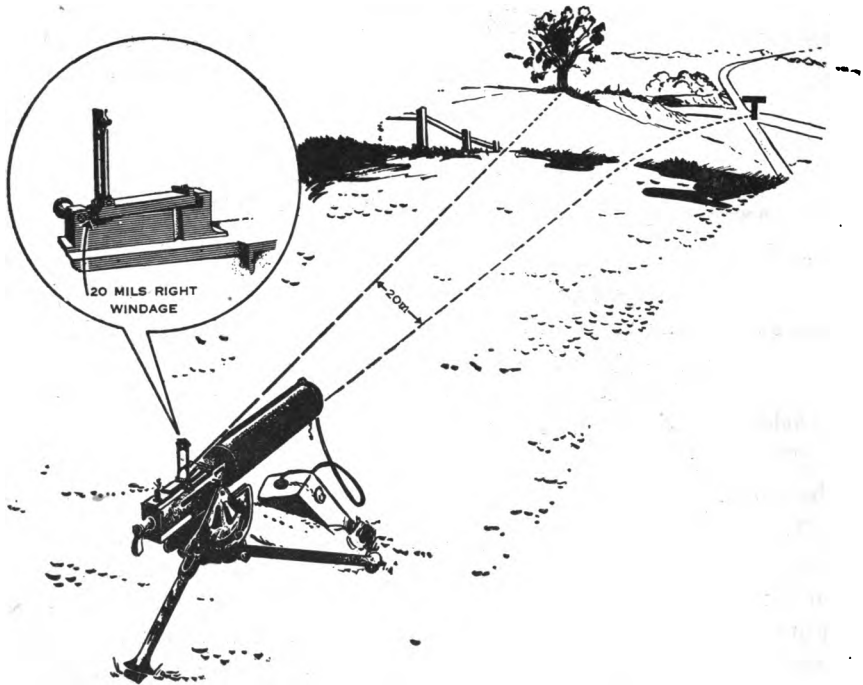


Figure 117. Aiming point method (direction).

aligned on the target. On the M1917A1 gun, the dial is then zeroed, and the trail leg floated. (See par. 86.)

*b.* USE OF AN AIMING POINT (fig. 117). A prominent landmark visible to the gunner through his sights is selected as an aiming point. An aiming point on the line gun-target and at an equal or greater range than the target is desirable. However, an aiming point on the mask may be used.

(1) If the aiming point is on the line gun-target, the gun is laid on the aiming point and is thereby aligned on the target.

(2) If the aiming point is not on the line gun-target, the deflection is measured by means of binocular or compass (or aiming circle, heavy gun). If the measured deflection is 20 mils (10 mils, light guns) or less, the necessary correction is set off on the windage gauge; if greater, on the traversing handwheel, on the dial of the M1917A1 tripod, or on the traversing slide of the M2 tripod.

*c.* AIMING STAKE METHOD (fig. 118). If no natural aiming point is available, an aiming stake may be set out, and the gun aligned on the target as described in *b* above.

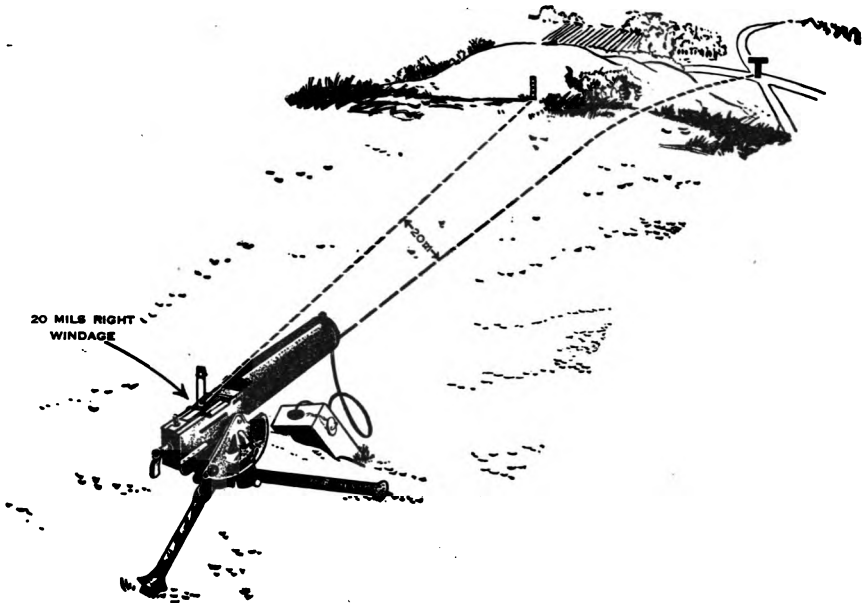


Figure 118. Aiming stake method (direction).

## 206. Laying Gun for Elevation

*a.* GENERAL. To lay the gun in elevation, a knowledge of the following fundamentals of indirect laying and of the use of firing tables is necessary.

(1) *Angle of elevation* (fig. 119). A straight line between the chamber of the gun and the target is called the line of site. Since the bullet begins its flight in prolongation of the axis of the bore and then, because of the action of gravity and air resistance, falls in a gradual curve, it is necessary to elevate the axis of the bore above the line of site, in order to hit a target at a given range. (See fig. 119.) The vertical angle *above* the line of site through which the axis of the bore must be raised so that the bullet will carry to the target is called the angle of elevation (AE). Thus the AE is always positive (plus), is constant for any given range, and increases as the range increases. The AE for each 100 yards of range up to 3,000 yards is given in paragraph 2, table I, appendix V. *Example*: To hit a target at a range of 1,000 yards, it is necessary to elevate the gun so that the bore forms an angle of +15 mils with the line of site.

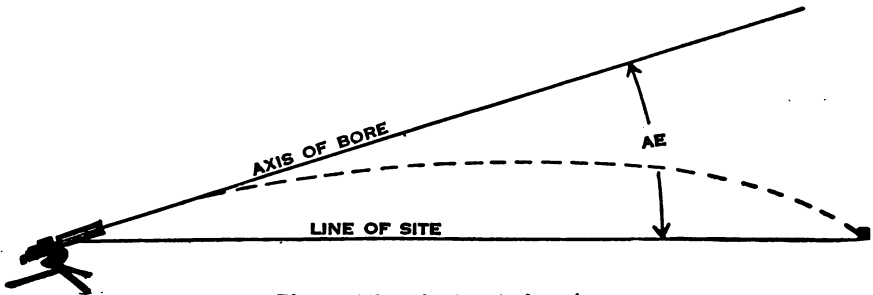


Figure 119. Angle of elevation.

(2) *Angle of site* (fig. 120). When the gun and target are not at the same elevation, an additional angle must be taken into consideration. This angle is a vertical angle formed by the line of site and a horizontal line through the chamber of the gun. It is called the angle of site (AS). (See fig. 120). If the target is at a higher elevation than the gun, the AS is positive (plus); if the target is lower than the gun, the AS is negative (minus).

(3) *Quadrant elevation*. The angle of quadrant elevation (QE) is the angle formed by the line extending through the axis of the bore toward the target and a horizontal line through the gun. The QE is positive (plus) whenever the gun is aimed above the horizontal, and negative (minus) whenever the gun is aimed below the horizontal. The QE is the *algebraic sum* of the AE and the AS; that is, if the AS is positive, it is added to the AE; if the AS is negative, it is subtracted from the AE.

(a) *QE when gun and target are on the same horizontal plane* (fig. 120①). The target is at a range of 1,000 yards and on the same hori-

zontal plane as the gun. Therefore the gun must be elevated to form an angle of 15 mils with the line of site (since +15 mils is the AE for a range of 1,000 yards). The AS is 0, because the line of site coincides with the horizontal. Therefore the QE is plus +15 mils (the algebraic sum of the AE, +15, and the AS, 0).

(b) *QE when the target is higher than the gun* (fig. 120③). The target is at a range of 1,000 yards and at a greater elevation than the gun. In order to hit the target, the gun must fire at an angle equal to the AE for the range (+15 mils) plus the AS. The AS is +5 mils, so the gun must be laid with a QE of +15 and +5, or a total of +20 mils.

(c) *QE when the target is lower than the gun* (fig. 120④). The target is at a range of 1,000 yards but at a lesser elevation than the gun. In order to hit the target, the gun must fire at an angle equal to the AE for the range (+15 mils) minus the AS. The AS is -5 mils, so the gun must be laid with a QE of +15 and -5, or a total of +10 mils. Figure 120④ illustrates a case where the target is at a range of 1,000 yards and the AS is -20 mils. Since the AE is +15 mils, the QE is the combination of +15 and -20, or an algebraic sum of -5 mils. Negative or minus angles of quadrant elevation are not common, but may be encountered on certain types of terrain.

**b. COMPUTED QE METHOD (HEAVY GUN).** (1) The range to the target is determined by use of the range finder, or is estimated, and the corresponding AE obtained from the firing tables.

(2) The angle of site is determined by use of the aiming circle or the binocular. When the binocular is used, the angle of site is determined by measuring the height of the target in mils, above the estimated horizontal. In estimating the horizontal, the distant horizon is assumed to be at an angle of site of zero, or at the same elevation as the gun position.

(3) The angle of quadrant elevation is determined by algebraically adding the data determined in (1) and (2) above. Place the QE on the gun with the clinometer.

**c. MEASURED QE METHOD (HEAVY GUN).** (1) The gun is located in partial defilade and laid on the target by direct laying methods. The QE is then measured with the clinometer.

(2) The gun is moved into position defilade, and the measured QE placed on the gun. For each yard difference in elevation between the position in partial defilade and the firing position, 1 mil is added to the QE when firing at a range of 1,000 yards,  $\frac{1}{2}$  mil when firing at 2,000 yards, etc.

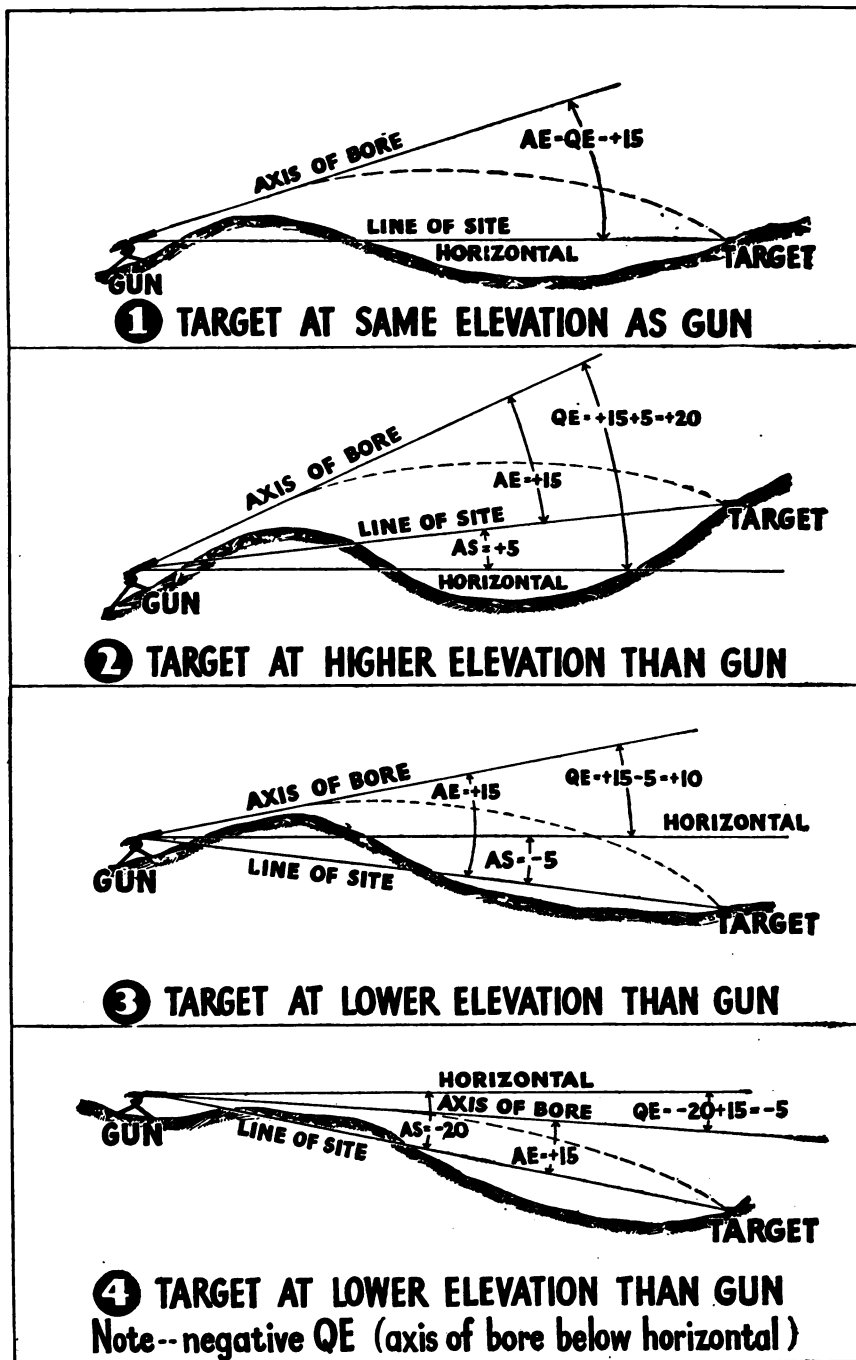


Figure 120. Angles of quadrant elevation (QE) to engage targets at 1,000 yards with M2 ball ammunition.

Note. If a clinometer is available, the methods described in *b* and *c* above may also be used with the light guns.

*d.* AIMING POINT METHOD. (fig. 121). An aiming point visible from the gun position is selected (preferably at a point at a greater range than the target, on the line gun-target, and above the target) and the range to the target determined as accurately as possible. The squad leader, using the binocular, measures the vertical angle in mils from the aiming point to the base of the target. He then lays the gun on the aiming point with the sight-setting to hit the target, and directs the gunner to manipulate the gun through the number of mils measured in the vertical angle from the aiming point to the base of the target. If the aiming point is off the line gun-target, deflection in mils may be taken with the windage arc if not over 20 mils (HMG); otherwise, the deflection must be compensated for by manipulation of the traversing handwheel. *Example:* In figure 121, the range to the target is 900 yards. The angle read with the binocular from the aiming point down to the target is 12 mils. The sight is set at 900 yards, gun laid on the aiming point with that sight setting, and the muzzle depressed 12 mils.

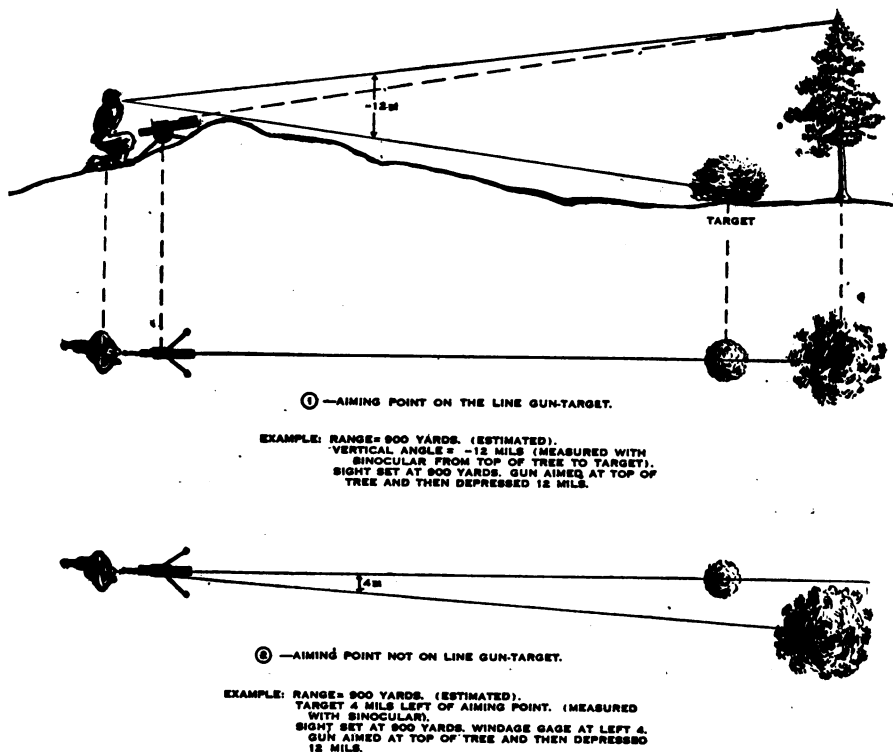


Figure 121. Aiming point method (elevation and/or direction).

## **207. To Establish Mask Clearance**

*a. GENERAL.* After the gun has been laid, if mask clearance is not obvious, it is necessary to determine whether or not the entire cone of fire will clear the mask.

*b. VISUAL METHOD.* (1) When the range to the mask is not more than 300 yards, mask clearance will exist when the axis of the bore is elevated 2 mils or more above the line gun-mask. Mask clearance can be checked, after the gun has been laid on the target by depressing the muzzle of the gun 2 mils and sighting along the lower edge of the water jacket (heavy gun) or the right side of the barrel jacket (light guns), in line with the axis of the bore. If the sight so taken clears the mask, mask clearance exists.

(2) A more accurate check is obtained by removing the back plate and the bolt, depressing the muzzle 2 mils, and sighting through the bore.

*c. BY USE OF FIRING TABLES.* The range to the mask is determined and the corresponding AE for mask clearance is found in the firing tables. Then the range corresponding to this AE is set on the gun sight. If the line of aim through the sights clears the mask, mask clearance exists.

## **208. Adjustment of Fire**

Under field conditions, the most practical methods of laying the gun on the target quickly will seldom result in an initial burst directly on the target. For this reason, rapid adjustment of fire on the target is essential. If the observer is properly trained in adjustment of fire, the accuracy of the initial burst is relatively unimportant, provided only that the strike of the bullets in the initial burst is in a position where the observer can see it.

*a.* Adjustment of fire should be bold and aggressive. The observer should command substantial corrections and avoid creeping toward the target.

*b.* When a burst is inaccurate for both deflection and elevation, the observer's next command should include corrections in both deflection and elevation.

*c.* Speed is vital. This is assured by thorough training in estimation of range and lateral distance and their translation into approximate values of mils.

*d.* To insure that the strike of the initial burst is seen by the observer, the burst should be long (20 to 40 rounds). Except for long ranges, or when for other reasons observation by eye is difficult, the binocular ordinarily will not be used for observation of the initial burst, since

in the event of an inaccurate initial laying, the resulting limitation of the observer's field of vision may cause him to miss the strike of the bullets.

### Section III. FIRE ORDERS AND NEW TARGETS

#### 209. Fire Orders

*a.* The elements of a fire order when firing from position defilade are given in the following sequence:

- (1) Instructions for laying on the target.
- (2) Fire distribution.
- (3) Fire control.

*b. EXAMPLE:* (1) AS LAID.

- (2) FIXED.
- (3) RAPID.
- (4) UPON SIGNAL.

#### 210. New Targets

New targets may be engaged as follows:

*a. DIRECT ALIGNMENT.* When the new target must be engaged quickly the fastest method is for each squad leader to shift to the new target by direct alignment, as described in paragraph 205*a*.

*b. ANGLE OF SHIFT.* The angle of shift is measured with the binocular, and the command RIGHT (LEFT) the required number of mils announced. When firing is by section, and either the new or old target is a wide target, with the guns laid on the respective flanks, the angle of shift for each gun must be announced separately. When the old target is a wide target, each gun must be relaid on the flank on which it was originally laid before the angle of shift is placed on the gun. The angle of shift is determined by measuring in mils the angle from the nearest flank to the new target for the gun laid on that flank. The angle of shift for the other gun is that angle plus the mil width of the target.



# CHAPTER 8

## TECHNIQUE OF FIRE: INDIRECT LAYING

---

### Section I. GENERAL

#### 211. Employment

*a. DEFINITION.* Indirect laying is the laying of machine guns in direction and elevation to engage a target that is not visible from the gun position. The gun is laid for direction by magnetic azimuth or by use of an initial aiming point, and for elevation by the use of the clinometer. Although indirect laying is possible with the light machine guns, the M2 tripod is not sufficiently stable to permit accurate fire on long-range targets. For this reason, indirect laying is not employed with these guns. This chapter is limited to the application of indirect laying methods employing the heavy machine gun.

*b. CAPABILITIES.* By the use of indirect laying, machine guns are capable of delivering area fire at ranges far beyond the usual limits of direct laying. Guns not engaged in firing primary missions, and guns in rear areas should be prepared to fire by indirect laying into critical areas which are within maximum range of the guns.

*c. FIRE MISSIONS.* By the use of indirect laying, machine gun units can deliver effective neutralization, interdiction, and harassing fire missions.

(1) Neutralization fire is fire delivered to cancel, balance or limit the effectiveness of an enemy area, weapon, installation, or force. Its chief use is to prevent the enemy from using his weapons effectively and to deny him effective observation.

(2) Interdiction fire prevents movement into or through an area. Its chief use is to deny the enemy routes of approach and areas for assembling or reorganizing.

(3) Harassing fire denies the enemy free and uninterrupted use of an area. Its chief use is to lower his morale and combat efficiency.

#### 212. Technique

*a. ACCURACY.* Since indirect machine gun fire is very difficult to adjust, it is imperative that firing data be obtained and computed accurately.

To do this requires a knowledge of the characteristics of fire, battery drill, fire control instruments, the mil formula, and firing tables. The computation of firing data demands exactness and close attention to details. Proficiency in this computation is acquired by practice in solving indirect laying problems.

*b. SOURCE OF FIRING DATA.* These data are obtained from a map or by terrain measurement (TOG method). Terrain measurement is more accurate.

*c. FIRE UNIT AND TASKS.* The usual fire unit for the execution of indirect fire missions is the platoon of four guns firing in battery. A square 100 yards on a side is employed as a target unit. Except for neutralization fire, which requires the fire of two platoons per square, two such squares can be covered by one platoon. A fire task consists of the covering by fire of not more than two squares. (See fig. 122.) In the case of two squares, they are adjacent, either laterally or in depth. Although the beaten zone of a single gun at ranges of 1,000 yards and greater is less than 100 yards in depth, differences between individual guns and minor variations in computing firing data combine to make the beaten zone of four guns firing in battery about 150 yards long and 20 yards wide, at any range.

*d. DENSITY OF FIRE.* The following table may be used as a guide to insure the proper density of fire in a square:

Mission	Ammunition per minute		Guns	Rate
	Rounds	Boxes		
Neutralization 1 sq.	2,000	8	8	Rapid
Interdiction 1 sq.	500	2	4	Medium or slow
			8	
2 sqs.	1,000	4	4 or 8	Rapid or Medium
Harrassing 1 sq.	250	1	4	Slow
2 sqs.	500	2	4 or 8	Medium or slow

*e. COMPUTING DATA. (1) Plotted point.* The point for which the firing data are computed is called the plotted point. It is the midpoint of the side of the square. If the task consists of two squares, the plotted point is the midpoint of the left side of the lower or left square. Each gun is laid initially on this point.

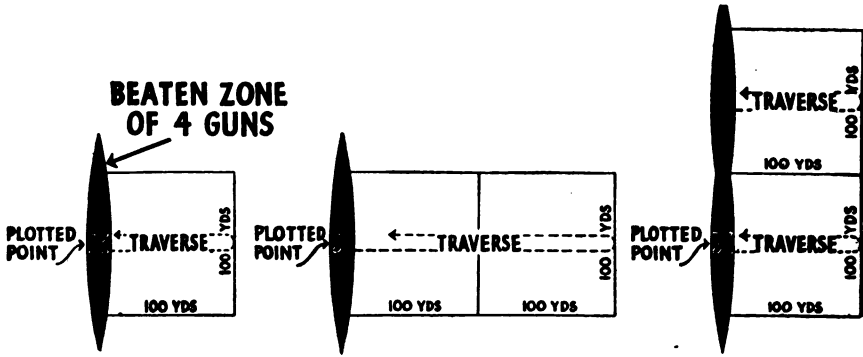


Figure 122. Methods of covering target areas using indirect fire.

(2) *Amount of traverse.* The amount of traverse per square can be obtained from paragraph 2, table IV, appendix V, if using M2 ball ammunition; from paragraph 13, table IV, appendix V, if using AP ammunition, regardless of the amount; or it may be computed by the mil formula. (See par 213c(2)(a).)

(3) *Amount of search.* (a) The amount of search for two squares is the difference between the AE for the range to hit the upper square and the AE for the range to hit the lower square.

(b) *Searching reverse slope.* Some missions require searching a reverse slope. If the area to be searched is just beyond the crest, the plotted point is on the crest. In computing the QE, 75 yards is added to the range to the plotted point. Usually this results in placing the impact area for one square just beyond the crest. The estimated size and shape of the reverse slope determine the number and arrangement of squares. At long ranges, it is improbable that any reverse slope will afford a sure defilade from fire, since angles of fall beyond 2,500 yards are very steep.

(4) *Uniform readings with fire control instruments.* To insure uniformity in obtaining indirect firing data on the ground, readings with fire control instruments are taken as follows:

- (a) If to a target, to the intersection of the target and the ground.
- (b) If to an aiming point, to a point at the base of the AP.

f. **EXECUTING TASKS.** The method of executing tasks is covered in battery drill. (See par. 92.)

g. **OBSERVATION OF FIRE.** If communication is provided between an observer and the battery, and strike can be observed, fire can be adjusted. Once it has been adjusted, aiming stakes are reset if necessary, and the QE measured on each gun.

## Section II. THEORY OF INDIRECT LAYING

### 213. Fundamentals

*a. GENERAL.* (1) *Essential factors of indirect laying.* Four essential factors must be considered in indirect laying. These are direction, elevation, mask clearance, and troop safety.

(2) *TOG method.* The simplest method of determining the four above-named factors is by the ground or TOG (target-observation post-gun) method. The observer occupies an observation post from which he can see the gun position, the mask, friendly troops if present, and the targets, and draws a diagram to scale of these various positions in relation to the observation post, using an aiming circle or compass to determine their magnetic azimuths and a range finder to determine their distance from the OP. He also measures the angle of site to the targets, guns, and mask. The data obtained are recorded. The M10 plotting board provides a rapid and convenient means of calculating and plotting TOG data. Its use is described in appendix V.

*b. DIRECTION.* (1) Having measured the azimuths and distances of the gun and target from his OP, the observer draws a north-south line on a piece of paper, marks a point on the line to represent the position of the OP (point selected must be so located that plotted material will not run off the paper), and with a protractor plots straight lines extending from the OP to the gun and target, using any convenient scale (such as 1 inch equals 200 yards).

(2) A straight line connecting the plotted positions of the gun and target will represent the direction in which the gun must be laid to hit the target. Having drawn this line, the observer can determine the range gun-target by measuring the line and applying the scale used in plotting.

*c. ELEVATION.* (1) *Angle of elevation.* The required elevation is placed on the gun with a clinometer after the angle of quadrant elevation (QE) has been computed. The QE is the algebraic sum of the angle of elevation (AE) and the angle of site (AS). The AE (gun-target) is obtained from the firing tables, the range from gun to target having been determined from the plotted diagram as described in *b* above.

(2) *Angle of site. (a) Mil formula.*

1. Computation of the angle of site involves a knowledge of the mil formula. A mil is an angle ( $\frac{1}{6400}$  of a circle) which subtends a width of 1 yard at a distance of 1,000 yards; 2 mils subtend a width of 2 yards, etc. At 2,000 yards, 1 mil subtends a width of 2 yards; 2 mils, 4 yards, etc. From the above examples, a formula can be derived as follows: Range

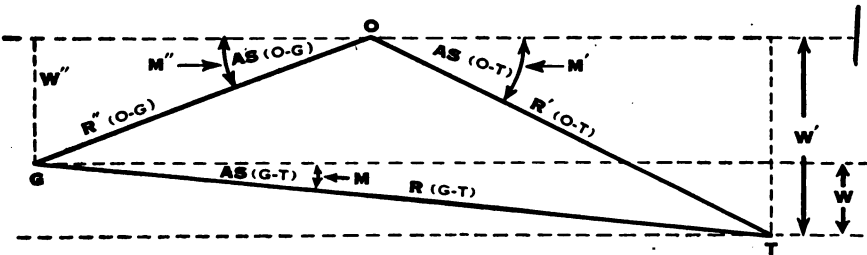
(in thousands of yards)  $\times$  mils = width subtended (in yards); or  $RM = W$ . In this equation, if the values of two of the elements are known and substituted for their equivalent letters, the value of the third can be found. *Example:* The range to a target is 5,000 yards (or 5, in thousands of yards). The number of mils which the target covers is 3. Substituting in the equation  $RM = W$ , we have  $5 \times 3 = W$ . Hence,  $W$ , the width of the target in yards, = 15.

2. A simplification of the mil formula, which permits a much speedier solution, is the WORM formula. The letters W-O-R-M stand for  $W$  over  $RM$ , or  $\frac{W}{RM}$ . The letters  $W$ ,  $R$ , and  $M$  stand, respectively, for width in yards, range in thousands of yards, and width in mils, as in the simplified mil formula described above. When the values of two of the elements are known, that of the unknown may be rapidly found by substituting these known values for the appropriate letters in the fraction  $\frac{W}{RM}$ , covering the letter whose value is unknown and solving for the visible figures. The result is the value of the third, or unknown, element. *Example:* With a target width of 10 yards, a range of 5,000 yards (or 5) and an unknown target width in mils, the known values 10 and 5 are substituted respectively for  $W$  and  $R$ . Covering  $M$  and solving the visible fraction gives an immediate result of 2, the value of  $M$ .
3. Decimals of .5 or greater are raised to a full mil. Decimals less than .5 are disregarded.

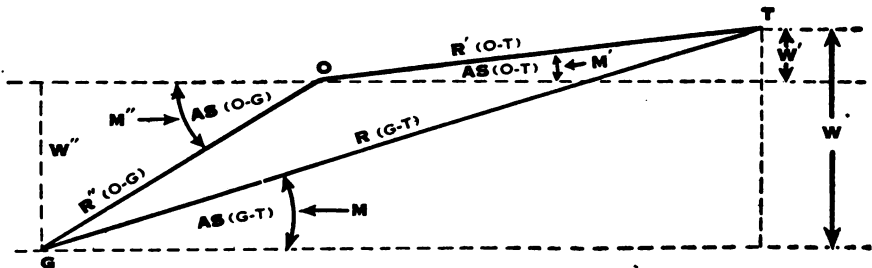
(b) *Procedure.* Determining the AS gun-target involves three distinct steps (see fig. 123):

1. Measure the AS, OP-gun (OP-G) and determine the range OP-G. Then by the mil formula determine the difference in altitude between OP and gun in yards.
2. Measure the AS, OP-target (OP-T) and determine the range OP-T. Then by the mil formula determine the difference in altitude between OP and target in yards as above.
3. From the above data determine the difference in altitude between the gun and target in yards, and by the mil formula solve for mils. ( $W$  is the difference in altitude between gun and target in yards, and  $R$  is the range.) The result is the AS, G-T, in mils. The AS, G-T, is plus if the target is above the gun, and minus if the target is below the gun.

1. Measure AS O-G ( $M''$ ).
2. Determine range O-G ( $R''$ ).
3. Determine, by the mil formula, the difference (in yards) between the altitudes of O and G ( $W''$ ).
4. Measure AS O-T ( $M'$ ).
5. Determine range O-T ( $R'$ ).
6. Determine, by the mil formula, the difference (in yards) between the altitudes of O and T ( $W'$ ).
7. Determine the difference (in yards) between the altitudes of G and T ( $W$ ). In figure 123①,  $W = W' - W''$ . In figure 123②,  $W = W' + W''$ . In both cases,  $W =$  the algebraic sum of  $W'$  and  $W''$ .
8. Determine range G-T ( $R$ ).
9.  $W$  and  $R$  now being known, the mil formula can be used to determine  $M$ , which is the AS G-T.



① Target below gun.



② Target above gun.

Figure 123. Computation of AS from OP.

d. MASK CLEARANCE. (1) *Explanation.* When the gun is laid to hit the target, it is essential to know whether or not the cone of fire will clear the mask. If it is found that the QE to hit the target is equal to or greater than the QE to clear the mask, it is certain that mask clearance exists. To find the QE to clear the mask, the AE to clear the mask and the AS gun-mask are added algebraically.

(2) *Methods of determining.* (a) *Firing tables.* The minimum AE to clear the mask for key ranges may be found by use of the firing tables (table III, par. 2, app. V, for M2 ball ammunition, or paragraph 14, table III, if AP ammunition is used in any proportion). (For explanation of use of table, see par. 6, appendix V.)

(b) *By use of trajectory and safety charts.* See paragraphs 15 and 15b, appendix V.

(c) *By use of rear sight.* See paragraph 7, appendix V.

e. **TROOP SAFETY.** (1) *Explanation.* Indirect fire very often will be delivered over the heads of friendly troops. Before engaging a target, it will be essential to know the minimum QE which can be placed on the gun and still maintain the safety of friendly troops. If it is found that the QE to hit the target is equal to or greater than the QE to clear the troops, the target can be engaged without endangering the troops. To find the QE to clear the troops, the AE for troop safety and the AS gun-troops are added algebraically.

(2) *Methods of determining.* (a) *Use of appropriate firing tables.* The minimum AE to clear the heads of friendly troops may be found by use of prepared tables (par. 2, table II, app. V, for M2 ball ammunition or par. 14, table II, appendix V, if AP ammunition is used in any proportion.)

(b) *Trajectory and safety charts.* Troop safety can be determined by consulting the trajectory and safety charts. (See pars. 15 and 15c, app. V.)

(c) *By using rear sight and firing tables.* Troop safety may be determined by using the rear sight. (See par. 5, app. V and appropriate firing tables.)

### Section III. SOLVING AN INDIRECT LAYING PROBLEM

#### 214. Illustrative Problem

a. **GENERAL.** The illustrative problem in this section is developed in a series of steps arranged to facilitate instruction. To aid in the solution, work sheets are provided. (See figs. 125① and ②.) In solving the problem, each step is numbered and that number precedes the corresponding entry on the work sheets and plotted diagram. (See fig. 126.)

*Note.* In this problem, all firing table data are taken from the table for M2 ball ammunition in paragraph 2, appendix V. When using AP ammunition, regardless of the amount, see the firing tables in paragraph 14, appendix V.

b. **SITUATION.** That part of the battalion attack order which pertains to the problem is given as follows (fig. 124): "One platoon of machine

guns of Co D, from firing positions on the southwest nose of ANDREWS HILL, will deliver long-range overhead fire to interdict CR 403 from H-hour minus 8 to H-hour \* \* \* be prepared to shift fire to the draw between MEAD HILL and MASON HILL on red parachute flare, and deliver harassing fire for 8 minutes. Upon completion of the second task, the platoon will cease firing and revert to company control \* \* \* .”

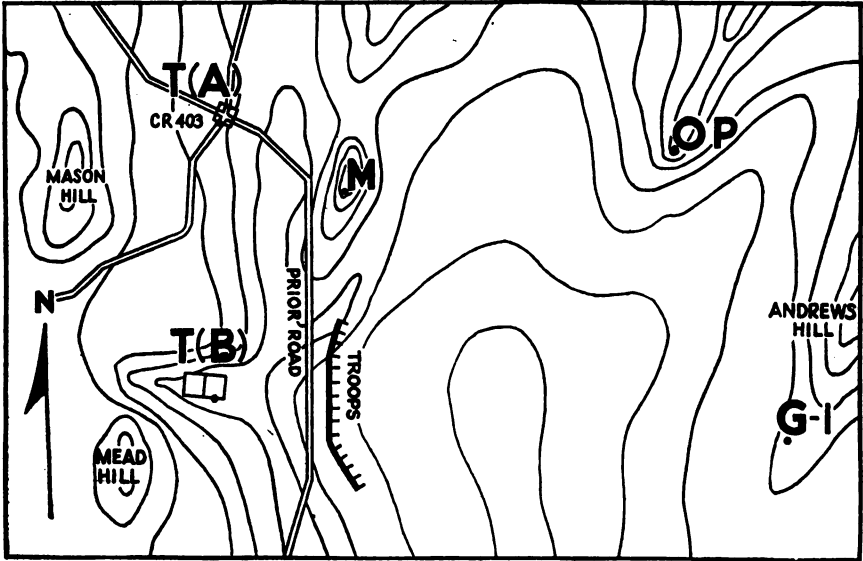


Figure 124. Map situation, illustrative problem.

c. REQUIREMENT. The platoon leader in order to fire his mission will have to know what direction to point his guns, what quadrant elevation will be required to hit the targets, whether the trajectory will clear the mask, and whether it will be safe to fire over the friendly troops. He will not be able to determine these things from the gun position because of the intervening mask. Therefore, in order to get this information, he will have to plot to scale the location of the gun, targets, mask, and the position of friendly troops in relation to his OP. He can do this by determining the azimuth, and the range to the gun, targets, mask, and position of friendly troops from the OP. To find the required quadrant elevation to hit the targets, clear the mask, and clear the friendly troops, he must also determine the angle of site from the OP to the gun, targets, mask, and position of friendly troops.

d. SOLUTION. (1) *Platoon leader's reconnaissance.* Upon receiving the order, the platoon leader, with his instrument corporal, reconnoiters the terrain. A battery position is located and gun No. 1 is set up at G-1.



Since this position, G-1, is hidden from the target by a mask, M, the platoon leader moves to a position (observation post) at OP, from which targets, gun, mask, and position of the friendly troops can be seen.

(2) *Preliminary data.* By the use of the aiming circle and range finder, the platoon leader and instrument corporal get the following data which is entered on their work sheet (fig. 125①):

- (a) Azimuth from OP to G-1 (2,850 mils.) Step (1).
- (b) Azimuth from OP to Trps. (4,198 mils.) Step (2).
- (c) Azimuth from OP to T (B). (4,340 mils.) Step (3).
- (d) Azimuth from OP to M. (4,700 mils.) Step (4).
- (e) Azimuth from OP to T(A). (4,900 mils.) Step (5).
- (f) Range from OP to G-1. (1,150 yards.) Step (6).
- (g) Range from OP to Trps. (1,640 yards.) Step (7).
- (h) Range from OP to T(B). (2,000 yards.) Step (8).

**DATA**

	O-G	O-Trps	O-T(B)	O-M	O-T(A)	
Az	(1) 2850	(2) 4,198	(3) 4,340	(4) 4,700	(5) 4,900	
R	(6) 1,150	(7) 1,640	(8) 2,000	(9) 1,285	(10) 1,740	
AS	(11) -8	(12) -9	(13) -4	(14) -2	(15) -3	
VI	(16) -9	(17) -15	(18) -8	(19) -3	(20) -5	
Area and Plotted Point			(21) <div style="border: 1px solid black; padding: 2px; display: inline-block;">*H</div>		(22) <div style="border: 1px solid black; padding: 2px; display: inline-block;">*I</div>	
Rate			(23) MED		(24) MED	
Time			(25) 8 ON RED ROCKET		(26) H-8 TO H	
Battery Front	(27) 100 YD		H-hour		(28) 0548	
Extending:	(29) 3,400 yd		Map:			
					G-1	G-4
Grid Azimuth of Base Line						
Declination Constant (Grid-Magnetic)						
Magnetic Azimuth of Base Line				(30) 5348	(31) 5382	

Date .....

*Figure 125①. Work sheet for illustrative problem.*

- (i) Range from OP to M. (1,285 yards.) Step (9).
- (j) Range from OP to T(A). (1,740 yards.) Step (10).
- (k) Angle of Site OP to G-1. (-8 mils.) Step (11).
- (l) Angle of Site OP to Trps. (-9 mils.) Step (12).
- (m) Angle of Site OP to T(B). (-4 mils.) Step (13).
- (n) Angle of Site OP to M. (-2 mils.) Step (14).
- (o) Angle of Site OP to T(A). (-3 mils.) Step (15).

### BATTERY CHART

(A)			TASK	(B)		
G-T	G-Trps	G-M		G-T	G-Trps	G-M
(27) 2,465	(27) 1,750	(27) 1,890	R	(27) 2,195		
(49) + 4	(52) - 6	(51) + 6	VI	(50) + 1		
(53) + 2	(56) - 3	(55) + 3	AS	(54) + 1		
(57) + 123	(59) + 92	(59) + 64	AE	(58) + 89		
(57) + 125	(60) + 89	(59) + 67	QE	(58) + 90		
IAP ----- OP -----						
Base Angle	Lay on IAP		Gun No	Angle of Shift	Lay on Base Lines	
	Dial	Add			Dial	Add
(38) L 705	(32) L 700	5	1	(39) L 440	(37) L 425	15
(39) L 707	(32) L 700	7	2	(36) L 439	(37) L 425	14
(34) L 709	(32) L 700	9	3	(64) L 438	(37) L 425	13
(33) L 711	(32) L 700	11	4	(35) L 437	(37) L 425	12
BASE STAKES OUT (66)				(66) RED STAKES OUT		
Sight R 14 (66)			FIRE ORDERS	Sight R 14 (66)		
Lay on Base Lines				Lay on _____ Stakes		
Boxes per Gun (62) 4				Boxes per Gun (62) 4		
QE (57) + 125				QE (58) + 90		
Traverse (Right) (64) 44				Traverse (Right) (64) 48		
Search Up (65)				Search Up (65) 11		
Rate (62) MED				Rate (62) MED		
Time (63) 0540-0548				Time (63) 8 ON RED ROCKET		

Figure 125(2). Work sheet (battery chart) for illustrative problem.

*Note.* From the OP it is impossible to determine the exact point on the mask where the bullets will cross. All data are therefore read to the highest point in the vicinity.

(3) *Plotting the problem. (a) General.* To determine the ranges from G-1 to T(A) and T(B), from G-1 to M, and from G-1 to Troops and the azimuth G-1 to T(A) and T(B), the simplest method is to plot the problem to scale using the data given above (steps 1 to 15), and then measure these ranges and azimuths on the scaled plotting. (The necessary equipment is a plain sheet of paper, a protractor, and a hard pencil with a sharp point.)

(b) *Method of plotting (fig. 126).*

1. As the aiming circle on the OP must be oriented on magnetic north before an azimuth is taken, indicate this orientation by drawing a magnetic north-south line on the plotting paper (step 16).
2. Select a point on this line as the observation post and mark it OP (step 17).
3. Orient the protractor on the right side of this line with its index at the OP: Plot the magnetic azimuth of OP to G-1 (2,850 mils), extend it to the edge of the sheet, and mark it GUN. (Step 18.)
4. Orient the protractor on the left side of the north-south line with its index at the OP. Plot the magnetic azimuth of the line OP to troops (4,198 mils), extend it, and mark it TROOPS. (Step 19.)
5. As in step 19, plot magnetic azimuth of the line OP-Target B (4,340 mils), extend it, and mark it TARGET B. (Step 20.)
6. As in step 19, plot the magnetic azimuth of the line OP-mask (4,700 mils), extend it, and mark it MASK. (Step 21.)
7. As in step 19, plot the magnetic azimuth of the line OP-Target A (4,900 mils), extend it, and mark it TARGET A. (Step 22.)
8. Using any convenient scale, such as 1:10,000 (or the scale along the base of the protractor), lay off on the appropriate lines the 1,150-yard range from the OP to the gun and mark the gun position G-1; the 1,640-yard range from the OP to the troops and mark the troop position TRPS; the 2,000-yard range from the OP to Target B and mark the target position T(B); the 1,285-yard range from the OP to the mask and mark the mask position M; the 1,740-yard range from the OP to Target A and mark the target position T(A). The same scale must be used throughout the problem. (Step 23.)

9. Draw the lines G-1-T(A) and G-1-T(B). (Step 24.)
10. Connect the points G-1 and M with a dotted line. (Step 25.)
11. Draw the line G-1-TRPS. (Step 26.)

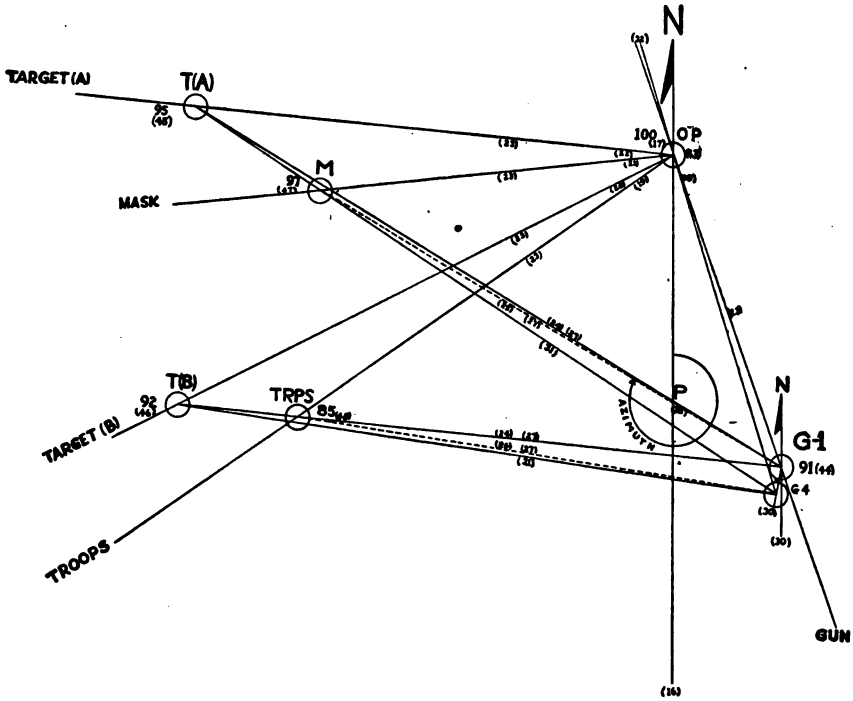


Figure 126. Plotting for illustrative problem.

12. Determine the range from G-1 to T(A), G-1 to T(B), G-1 to M, and G-1 to TRPS, by measuring the plotted lines and applying the scale. Enter the ranges on the work sheet. (See fig. 125②.) These ranges are—

G-1 to T(A)	2,465 yards (Step 27.)
G-1 to T(B)	2,195 yards
G-1 to M	1,890 yards
G-1 to TRPS	1,750 yards

(4) *Establishing direction, gun-target.* (a) *One gun.* The simplest method of laying the gun for direction on the primary target is to use the observation post as an initial aiming point (IAP), and then turn the gun through the base angle OP-G-1-T(A), (See fig. 127.) The gun will then be laid on the base line G-1-T(A). To determine the direction to Target B the simplest method is to turn the gun in an angle of shift. An angle of shift is the angle through which a gun must turn from its

base line in order to lay on a second (third) (fourth) task. One side of the angle of shift is always the base line. The base angle and angles of shift can be measured from the plotted data.

1. To measure the base angle (OP-G-1-T(A)), lay the protractor along the left side of the line G-1-OP, with the index at G-1, and note the reading on the protractor opposite the line G-1-T(A) (the base line). As measured, the base angle is found to be 705 mils left (left, because from the gun position T(A) is to the left of the OP). The base angle is entered on the work sheet, figure 125②. (Step 28.)

*Note.* It is important that the magnetic azimuth of the base line (G-1-T(A)) be established for use in laying for direction in case the IAP (the OP in this case) becomes invisible because of smoke or darkness. This azimuth may be measured on the plotted sketch. Draw a north-south line through OP, and indicate its intersection with the line G-1-T(A) by the letter P. (See fig. 127.) Lay the protractor along the left side of the north-south line with its index at P, and measure the angle OP-P-T(A) clockwise. As measured, the line P-T(A) falls on the 5,348-mil graduation, and this azimuth is entered on the work sheet. (See fig. 125①.)

2. To measure the angle of shift from T(A) to T(B), lay the protractor along the left side of the line G-1-T(A) with the index at G-1, and note the reading on the protractor opposite the line G-1-T(B). As measured, the angle of shift is 440 left (left, because T(B) is to the left of the base line, G-1-T(A)). This is entered on the work sheet, figure 125②. (Step 29.)

(b) *Base angles and angle of shift for other guns in the battery.* Assume that the four guns of the platoon have been placed at regular intervals in a straight line on level ground. Firing data for G-1 are known. It now becomes necessary to know the direction in which the battery extends from G-1 and the direction in which the other guns in the battery must be pointed to hit the targets. The gun on the opposite end of the battery from G-1 is represented in figure 127 as G-4

1. To determine the battery direction, measure the azimuth from G-1 to G-4. This is found to be 3,400 mils. Now lay off a line representing the battery front on an azimuth of 3,400 mils from G-1. To do this, draw a new north-south line through G-1, and use this line as the base for laying off the azimuth of the battery front. The length of the battery front is paced or measured with a tape, as the distance is too short for the range finder. The distance from G-1 to G-4 (battery front) is found to be 100 yards, and entered on the work sheet. (See fig. 125①.) A point, G-4, is marked off to scale on the battery line 100 yards from G-1. (Step 30.)

2. The lines G-4-T(A) and G-4-T(B) are then drawn. (Step 31.)
3. The line G-4-OP is drawn. (Step 32.)
4. To obtain the base angle for G-4, the procedure is similar to that described in step 28. Thus, the base angle for G-4, is left 711 (left, because the target is left of the IAP). This is entered on the work sheet. (See fig. 125②.) (Step 33.)
5. The base angles for G-1 (left 705) and G-4 (left 711) now being known, the base angles for guns Nos. 2 and 3 can be determined by interpolation. The difference between the base angles of G-1 and G-4 is found by subtraction,  $711 - 705 = 6$ . This difference is divided by the number of intervals (three) between the four guns, or  $6 \div 3 = 2$ . This is the difference between the base angles for any two adjacent guns. Thus:

Base angle for G-1 is L705.

Base angle for G-2 is L705 plus 2, or L707.

Base angle for G-3 is L707 plus 2, or L709.

Base angle for G-4 is L709 plus 2, or L711.

These angles are entered on the work sheet. (See fig. 125②.) As in step 28, the base-line azimuth for G-4 is determined (in this case, 5,382) and entered on the work sheet. (See fig. 125①.) The base-line azimuths for guns Nos. 2 and 3 are then determined by interpolation in a manner similar to that described above for base angles. (Step 34.)

6. The angle of shift for G-1 is left 440. The angle of shift for G-4 is found, as in step 29, to be left 437. This is entered on the work sheet. (See fig. 125②.) (Step 35.)
7. As in step 34, the angles of shift for guns Nos. 2 and 3 can be determined by interpolation. These angles are entered on the work sheet. (See fig. 125②.) (Step 36.)
8. The base angles and angles of shift, after being entered on the work sheet, are converted into terms of dial and micrometer readings. These are also entered on the work sheet. (See fig. 125②.) (Step 37.)

(5) *Establishing elevation.* (a) *Use of the WORM formula* (par. 213c(2)(a)2). By the use of the WORM formula it is possible to determine Range (R), AS (M), or VI (vertical interval) (W), from the gun to targets, mask, or position of friendly troops if any two elements in each instance are known. The ranges (step 27), and angles of site (steps 11-15) from OP to these points being already known, it is there-

fore possible, by using the WORM formula, to determine the VI in the following manner:

1. The VI from OP to G-1 is found

$$\frac{VI}{1.150 \times -8} = -9.200 \text{ or } -9 \text{ yards.} \quad (\text{Step 38.})$$

2. The VI from OP to position of friendly troops is found

$$\frac{VI}{1.640 \times -9} = -14.760 \text{ or } -15 \text{ yards.} \quad (\text{Step 39.})$$

3. The VI from OP to Target B is found

$$\frac{VI}{2.000 \times -4} = -8.000 \text{ or } -8 \text{ yards.} \quad (\text{Step 40.})$$

4. The VI from OP to mask is found

$$\frac{VI}{1.285 \times -2} = -2.570 \text{ or } -3 \text{ yards.} \quad (\text{Step 41.})$$

5. The VI from OP to Target A is found

$$\frac{VI}{1.740 \times -3} = -5.220 \text{ or } -5 \text{ yards.} \quad (\text{Step 42.})$$

The VI's found in steps 38-42 are entered on the work sheet. (See fig. 125①.)

(b) *Relative elevations and VI.*

1. The difference between the elevation of the gun, targets, mask, and friendly troops and that of the OP is now known. To establish the elevation of each point in relation to the others, the OP is arbitrarily assigned an elevation of 100 yards, which is entered on the plotted figure. (See fig. 126.) (Step 43.)
2. It has been determined that the VI OP-G-1 is -9 yards, that is, that the OP is 9 yards higher than the gun. Thus, if OP is at an elevation of 100 yards, G-1 is at an elevation of 91. This elevation is entered on the plotted figure. (Step 44.)
3. The VI OP-T(A) was found to be -5 yards. Therefore the elevation of T(A) is 95 yards, which is entered on the plotted figure. (Step 45.)
4. The VI OP-T(B) was found to be -8 yards. Therefore the elevation of T(B) is 92 yards, which is entered on the plotted figure. (Step 46.)
5. The VI OP-M was found to be -3 yards. Therefore the elevation of M is 97 yards, which is entered on the plotted figure. (Step 47.)
6. The VI OP-TRPS was found to be -15 yards. Therefore the elevation of TRPS is 85 yards, which is entered on the plotted figure. (Step 48.)

7. Since the relative elevation of G-1 has been established as 91 yards and that of T(A) as 95 yards, the difference in elevation between the two points is 4 yards. G-1 being lower than T(A), the VI G-1-T(A) is +4 yards. This is entered on the work sheet. (See fig. 125②.) (Step 49.)
8. Similarly, the relative elevation of T(B) has been established as 92 yards. The relative elevation of G-1 is 91 yards, so the VI G-1-T(B) is +1 yard. This is entered on the work sheet. (See fig. 125②.) (Step 50.)
9. The relative elevation of M has been established as 97 yards. Thus the VI G-1-M is +6 yards. This is entered on the work sheet. (See fig. 125②.) (Step 51.)
10. The relative elevation of TRPS has been established as 85 yards. Since the elevation of G-1 is 91 yards, the VI G-1-TRPS is -6 yards. This is entered on the work sheet. (See fig. 125②.) (Step 52.)

(c) *Angles of site.* Since the ranges (measured from the plotted figure) and the vertical intervals from G-1 to T(A), T(B), M, and TRPS are known, the AS from G-1 to these points can be determined by the WORM formula, as follows:

1. For G-1 -T(A):

$$\text{Width (VI)} = +4$$

$$\text{Range (in thousands of yards)} = 2.465$$

$$\text{AS} = \frac{4}{2.465} = 1.6 \text{ mils. This is taken as 2 mils. (Step 53.)}$$

2. For G-1 -T(B):

$$\text{VI} = +1$$

$$\text{R} = 2.195$$

$$\text{AS} = \frac{1}{2.195} = .5 = 1 \text{ mil. (Step 54.)}$$

3. For G-1 -M:

$$\text{VI} = +6$$

$$\text{R} = 1.89$$

$$\text{AS} = \frac{6}{1.89} = 3.2 = 3 \text{ mils. (Step 55.)}$$

4. For G-1 -TRPS:

$$\text{VI} = -6$$

$$\text{R} = 1.75$$

$$\text{AS} = \frac{-6}{1.75} = 3.4 = -3 \text{ mils. (Step 56.)}$$

(The AS found in steps 53-56 are entered on the work sheet. (See fig. 125②.)



(d) *Angles of elevation and QE.*

1. *Target A.* The AE for a range of 2,465 yards is found by interpolation (par. 2, table I, app. V) to be +123 mils. This is entered on the work sheet. (See fig. 125②.) The AE of +123 mils and the AS of +2 mils are added algebraically, giving a QE of +125 mils, which is entered on the work sheet. (See fig. 125②.) (Step 57.)
2. *Target B.* The AE for a range of 2,195 yards is +89 mils. This is entered on the work sheet. (See fig. 125②.) The AE of +89 mils and the AS of +1 mil are added algebraically, giving a QE of +90 mils, which is entered on the work sheet. (See fig. 125②.) (Step 58.)
3. *Mask clearance.* The minimum AE to clear the mask at a range of 1,890 yards is found by interpolation in paragraph 2, table III, appendix V to be +64 mils, which is entered on the work sheet. (See fig. 125②.) The AE of +64 mils and the AS of +3 mils are added algebraically, giving a QE of +67 which is the minimum QE necessary to clear the mask. This is entered on the work sheet. (See fig. 125②.) Since the QE, G-1-T(A) (+125 mils) and the QE, G-1-T(B) (+90 mils) are greater than the minimum QE to clear the mask (+67 mils), mask clearance exists in both cases. (Step 59.)
4. *Troop safety.* The minimum AE to clear the friendly troops at a range of 1,750 yards is found in paragraph 2, table II, appendix V, to be +92 mils, which is entered on the work sheet. (See fig. 125②.) The AE of +92 mils and the AS of -3 mils are added algebraically, giving a QE of +89, which is entered on the work sheet. (See fig. 125②.) Since the QE to hit T(A) is +125 mils and that to hit T(B) is +90 mils, both of which are greater than the minimum QE required to clear the friendly troops, it is safe to fire on both targets. (Step 60.)

**215. Illustrative Problem: Completing Battery**

a. *SITUATION.* The necessary data to place fire on the targets have been obtained. Most of the additional information needed for the fire order can now be derived from these data. Before the attack is to commence, the battalion commander advises that H-hour is 0548; and in the attack order, directs that Task A consist of one square, and Task B of two squares extended in depth.

b. REQUIREMENT. Battery firing data to include the following:

- (1) Rate of fire and amount of ammunition for each task.
- (2) Amount of traverse and search for each task.
- (3) The time to commence and cease firing.
- (4) Windage corrections.

c. SOLUTION. (1) Task A consists of a fire mission on one 100-yard square, firing data having been calculated to the midpoint on its left edge. (See fig. 127.) Task B consists of a fire mission on two such squares extended in depth, firing data having been calculated to the midpoint of the left edge of the lower square. Rough diagrams of these

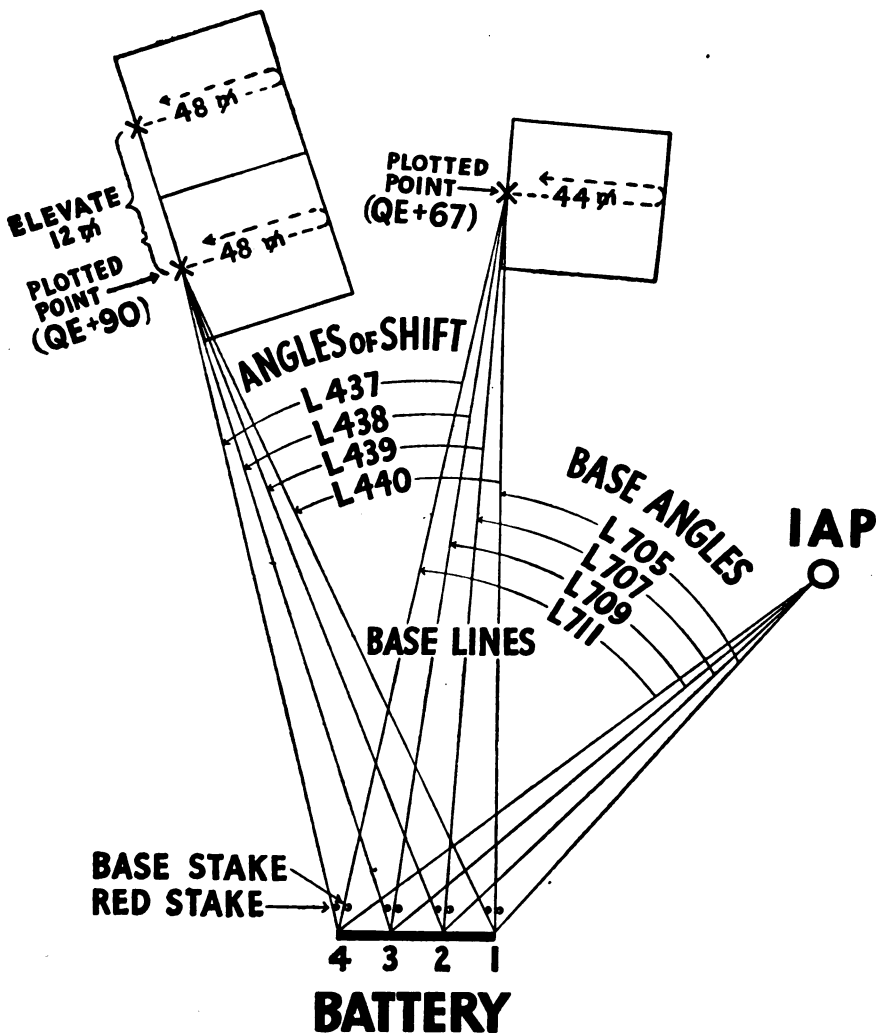


Figure 127. Tasks A and B.

tasks are drawn on the work sheet, figure 125①, with the plotted points indicated by an "X," the letter "I" denoting the interdicting mission and the letter "H" denoting the harassing mission. (Step 61.)

(2) The rate of fire is determined from the table in paragraph 212*d*. The interdiction fire on Task A (one square) requires 500 rounds per minute when the 4 guns of the platoon fire at the medium rate. This is equivalent to 2 boxes of ammunition per minute for the battery as a group. To fire continuously for 8 minutes will require 16 boxes for the battery, or 4 boxes per gun. The harassing fire on Task B (two squares) will also require 500 rounds per minute when firing at the medium rate. Firing continuously at this rate for the 8 minute mission will take 4 boxes per gun. This information is entered on the work sheet. (See figs. 125① and ②.) (Step 62.)

(3) The length of time to engage Task A, as given in the battalion order, is from H-hour minus 8 to H-hour. H-hour is the time of attack, 0548. H-hour minus 8 is 8 minutes before the attack, or 0540. Thus, the length of time for Task A is entered on the work sheet, figure 125②, as 0540-0548. Fire is to be shifted to Task B on red rocket signal and continued for 8 minutes thereafter. These data are entered on both sheets, (See fig. 125① and ②.) (Step 63.)

(4) The amount of traverse necessary in both tasks may be determined by the mil formula. The required data have already been computed, however, and can be taken directly from paragraph 2, table IV, appendix V. Thus, the square for Task A, which has a width of 100 yards and is at a range of 2,465 yards, will be covered by a 44 mil traverse (44 mils, because any range less than 2,500 yards requires a traverse of more than 40 mils, and because the amount of traverse must be a multiple of 4 since each gun is traversed in moves of 4 mils each). The square for Task B, also 100 yards in width and at a range of 2,195 yards, will require a 48 mil traverse. These data are entered on the work sheet. (See fig. 125③.) (Step 64.)

(5) The square for Task A, being 100 yards in depth, requires no search. The words SEARCH UP are, therefore, lined out on the work sheet. Task B, 200 yards in depth, requires some search, the amount of which can be determined from paragraph 2, table I, appendix V. The amount of search is the difference between the AE for the range to the plotted point of the lower square and the AE for the range to a point 100 yards beyond. The plotted point is at a range of 2,195 yards. The AE for this range is 89 mils; and for 2,295 yards, by interpolation, 100 mils. The difference is 11 mils. This is the amount of search, and is entered on the work sheet (See fig. 125④.) (Step 65.)

(6) Black-and-white aiming stakes are used to mark base lines, which

in this problem are the directional lines for Task A. In this problem, red stakes are used to mark the directional lines for Task B.

(7) The final step in formulating the fire order is to consider windage corrections, if necessary. These corrections must be determined at the gun position at the time of firing. They comprise three factors: a possible adjustment in direction because of a crosswind; a possible change in elevation because of a headwind or a tailwind; and a probable correction in direction due to drift. The first two factors depend upon the force and direction of the wind and the range to the target; the third, upon the extent to which the bullet will drift to the right during its flight from gun to target. Each of these factors is constant for given ranges, and for given wind velocities and directions. The applicable corrections appear in appendix VI. Assuming a 10-mile wind from 3 o'clock at the time firing is to commence, windage is calculated as follows:

(a) For Task A, which is at a range of 2,465 yards, the windage correction for a 10-mile wind from 3 o'clock is found by interpolating between the corrections required for ranges of 2,000 and 2,500 yards. These corrections are right 10 and right 13 mils, respectively. (See paragraph 2, table VIII B, appendix V.) The difference in range being 500 yards and in windage, 3 mils, Task A then requires a correction of right 10 mils plus  $465/500$  of the 3-mil difference between the two key ranges, or 12.8 mils. From paragraph 2, table VII, appendix V, it is found that an additional correction of right 1.2 mils is necessary to compensate for drift. Thus, the total correction is right 14 mils, which is entered on the work sheet (fig. 125②) and announced in the fire order. From paragraph 2, table VIII A, appendix V, it is found that no change in elevation is required for a 3 o'clock 10-mile wind.

(b) Should the force and direction of the wind change by the time Task B is to be fired, windage must be redetermined. Assuming no appreciable change in conditions for Task B, it is found in the manner described in (a) above, that a correction of right 11.2 mils is required for the wind, plus an additional 3.1 mils right windage for drift, paragraph 2, table VII, appendix V, or a total correction of right 14.3 (considered to be 14). This is entered on the work sheet. (See fig. 125②.) As in the case of Task A, no change in elevation is required. (Step 66.)

(c) The above computations are for M2 ball ammunition.

## 216. Illustrative Problem: Firing the Battery

a. TASK ORDER AND EXECUTION. Before the firing is to begin, the battery commander announces the task order from his completed work

sheet (fig. 125②), which now constitutes the battery chart. The sequence of the order and the manner of execution is as follows (sec. VI, ch. 2):

- | <i>Task order</i>  | <i>Execution</i>   |
|--|--|
| (1) LAY ON IAP.  | (by each gun crew, squad leader repeating all commands of battery commander).<br>Squad leader loosens traversing clamp.<br>Gunner sets rear sight at maximum elevation, windage gauge at zero, zeros traversing micrometer, and lays on IAP. Squad leader tightens clamp, zeros dial. (Note. Upon completing operations required by each order, No. 2 signals "Up" to the section leader who, in turn, signals "Up" to the battery commander.) |
| (2) NO. 1 LEFT 700<br>ADD 5.<br>NO. 2, LEFT 700<br>ADD 7.<br>NO. 3, LEFT 700<br>ADD 9.<br>NO. 4, LEFT 700<br>ADD 11.     | Squad leader repeats the command which applies to his particular gun, loosens traversing clamp, and assists gunner to lay off base angle as directed. Windage gauge remains at zero, rear sight slide at maximum elevation. Squad leader tightens traversing clamp.  |
| (3) BASE STAKES<br>OUT.  | No. 3 puts out black and white stake.  |
| (4) LAY ON BASE<br>STAKES.   | Gunner centers traversing gear housing and then taps gun on line. The guns are now laid on their base line, that is, in the direction to execute Task A. Squad leader again zeros the dial, since the angles of shift to all other tasks will be measured from the base line.  |
| (5) NO. 1, LEFT 425<br>ADD 15.<br>NO. 2, LEFT 425<br>ADD 14.<br>NO. 3, LEFT 425<br>ADD 13.<br>NO. 4, LEFT 425<br>ADD 12. | Squad leader and gunner repeat the same steps as in laying off the base angle (step 2 above). Having laid off the angle of shift, the guns are now laid in direction to execute Task B.  |
| (6) RED STAKES<br>OUT.   | No. 3 puts out red stakes.   |

b. FIRE ORDER AND EXECUTION. Immediately before firing is to begin, the battery commander calculates the windage and announces the fire order. The sequence of the order and the manner of manipulation are as follows:

<i>Fire order</i>	<i>Manipulation</i>
(1) SIGHT RIGHT 14.	(by each gun crew) Gunner sets rear sight at maximum elevation; windage gauge at right 14. He moves the gear housing to the right end of the traversing screw in order to permit the maximum amount of traverse to the right during the delivery of fire (occasionally the initial traverse may be to the left, in which case the opposite procedure is followed).
(2) LAY ON BASE LINES.	Squad leader loosens traversing clamp. Gunner lays on black and white stake. Squad leader tightens clamp and checks to see that the dial is zeroed.
(3) BOXES PER GUN: 4.	No. 3 brings ammunition forward.
(4) QE: +125 (announced as "plus one two five").	Squad leader places QE on gun by use of clinometer.
(5) TRAVERSE RIGHT 44.	
(6) MEDIUM.	
(7) UPON SIGNAL.	
(8) (At 0540 hours) Signal: COM- MENCE FIRING.	Gunner fires in bursts of 8 to 10 rounds, traverses right 44 mils in 4-mil moves, firing a burst after each change of direction. At completion of right traverse, squad leader checks QE with clinometer. The gunner traverses 44 mils left in 4-mil moves, firing a burst after each change, and relays on base stake. Squad leader again checks QE, and operation is repeated.
(9) (At 0548 hours) Signal: CEASE FIRING.	
(10) SIGHT RIGHT 14.	Gunner sets windage gauge at right 14 and repeats procedures as in (1) above.

*Fire order*

(11) LAY ON RED STAKES.

(12) BOXES PER GUN: 4

(13) QE: +90.

(14) TRAVERSE RIGHT 48.

(15) SEARCH UP 12.

(16) MEDIUM.

(17) UPON SIGNAL.

(18) (Upon red rocket signal) Signal: COMMENCE FIRING.

(19) (At 8 minutes after red rocket signal) Signal: CEASE FIRING.

c. SCHEME OF EXECUTION. The execution of the task and fire orders is diagrammed in figure 127.

*Manipulation*

Squad leader loosens traversing clamp. Gunner moves gear housing to right end of traversing screw and then lays on red stake with sight slide at maximum elevation. Traversing clamp is tightened.

No. 3 brings ammunition forward.

Squad leader places QE on gun with clinometer.

Gunner fires in bursts of 8 to 10 rounds, traversing 48 mils to right in 4-mil moves, firing a burst after each change. At completion of right traverse, squad leader checks QE with clinometer. Gunner traverses 48 mils left in 4-mil moves, firing a burst after each change, then relays on red stake, and squad leader checks QE. Gunner elevates 12 mils without firing, and traverses right 48 mils in 4-mil moves, then left 48 mils in 4-mil moves, firing a burst after each change. At completion of this traverse he again relays on red stake, and squad leader checks QE. Operation is repeated. (*Note.* Direction and elevation are checked in lower square only. Clinometer is set at the lower QE and not changed.)

## CHAPTER 9.

### ARMORED APPLICATION (M1919A4 MACHINE GUN)

---

#### Section I. MOUNTS AND MOUNT ADJUSTMENT

##### 217. Mounts

*a. GENERAL.* Vehicular mounts for the Browning machine gun, caliber .30, HB, M1919A4, are of three general types:

- (1) The ball type.
- (2) The pintle and trunnion type.
- (3) The coaxial type.

*b. BALL TYPE MOUNT.* The ball type mount is secured directly to the hull of the vehicle and allows considerable freedom of manipulation of the gun, which protrudes through the armor of the hull or turret. Some ball type mounts include a gun cradle.

*c. PINTLE AND TRUNNION TYPE MOUNT.* This type of mount may be attached by means of a pedestal or bracket, bolted or welded to the frame, body, or hull; or by blocks operating on a ring or track on the body or turret. Most mounts of this type include a gun cradle. The cradles are designed to permit free manipulation within the limits of elevation and deflection of the mount. They are also provided with slow-action manipulating mechanisms graduated in 1-mil increments.

*d. COAXIAL MOUNT.* The coaxial mount provides for mounting the machine gun parallel to the tank cannon. The cannon and machine gun are thus adjusted simultaneously when the cannon is manipulated for elevation and deflection.

##### 218. Mounting Gun

*a. GENERAL.* The gun is attached to the mount or cradle by means of pins or bolts. Guns which are attached directly to the mount are secured by a single trunnion pin or bolt. Guns which are mounted in a cradle are secured by a trunnion pin or bolt and an elevating bracket pin or bolt.

*b. TO MOUNT.* (1) Remove pins or bolts.



(2) Insert gun (muzzle first, for turreted vehicles) in the mount or cradle.

(3) Align holes in the gun with holes in the mount or cradle and insert and secure pins and bolts. When installing the gun in a mount which requires the use of either a separate gun pintle or elevating mechanism, or both, the gun pintle and elevating mechanism may be attached to the gun, as described above, before the gun is placed in the vehicle. To mount the gun, place the gun in the pintle housing, latch it, and clamp the traversing block on the traversing bar.

#### **219. Adjustment of Coaxial Gun Mounts**

For adjustment of coaxial gun mounts, see FM 17-12.

### **Section II. SIGHTS AND SIGHT ADJUSTMENT**

#### **220. Sights Used with Turret Guns**

For a complete description of the design, use, care and preservation, and adjustment of telescopic and periscopic sights used with turret guns, see FM 17-12.

#### **221. Adjustment of Sights**

To adjust sights for coaxial machine guns, follow the procedure set forth in FM 17-12.

### **Section III. PLACING GUNS IN ACTION**

#### **222. Training for Placing Guns in Action**

FM 17-67, 17-68, 17-69, and 17-75 cover the technique of placing guns mounted in armored vehicles in action, vehicle evacuation, and dismounted action. Chapter 6 of this manual and FM 17-12 cover fire orders.

### **Section IV. MARKSMANSHIP TRAINING**

#### **223. Firing from Vehicles**

*a.* **COAXIAL GUNS.** FM 17-12 covers the use of the coaxial machine gun.

*b.* **PEDESTAL MOUNTS.** Pedestal mounts are unstable and lack the rigidity required to deliver accurate fire. The gunner uses the machine gun as a free weapon and considerable skill is required in directing fire. Because of the excessive vibration set up in firing from pedestals, the

gunner must exert great effort to keep the tracer stream on the target. He keeps the weight of his body against the grip or backplate at all times to cut down vibrations while firing. He makes changes in direction of fire by moving his body. Sudden shifts throw the gunner off balance and result in erratic shooting.

*c.* **RING MOUNTS.** The ring mounts on most vehicles are of such size that the gunner cannot use sights except for very deliberate fire. Usually fire is delivered as from a skate mount and the usual use of such mount is for antiaircraft firing, which is by tracer control. (See ch. 5.)

*d.* **BALL MOUNTS.** Bow guns mounted in ball mounts cannot be directed or aimed by any mechanical means. It is difficult to observe the original tracer stream.

(1) The gunner may depress the gun and fire directly to the front into the ground. As soon as strikes are observed, he elevates the muzzle until the strike moves to the vicinity of the target. The gun should be firmly held with both hands, one on the grip and one on either the top of the receiver or its rear portion. Holding the gun firmly in one position, he moves the body to traverse, elevate, or depress the gun.

(2) The gunner may be trained to assume a position at his gun which automatically causes it to be parallel to the ground. In training, a coach stationed outside the vehicle and to the right of the gun barrel jacket can correct the gunner's holding. By repeated practice, the gunner teaches himself just where to hold the gun and what body position to assume to assure a good initial alignment. A few bursts fired at a range of 200 to 400 yards on level terrain further correct the gunner's position and holding. This method is practicable only on level or evenly sloping ground.

## **224. Courses to Be Fired**

*a.* **QUALIFICATION COURSES.** The following qualification courses are fired by units equipped with the Browning machine gun, cal. .30 M1919A4 (mounted in combat vehicles):

- (1) Course A consists of tables I, II, and IV.
- (2) Course B consists of tables III and IV.
- (3) Course C consists of tables I and II.
- (4) Course D consists of table III.

*b.* **DETAILED INSTRUCTIONS.** Personnel to fire, ammunition allowances, and qualification scores are prescribed in AR 775-10; targets, in TM 9-855; records and reports, in AR 345-1000.

Table I. Ground mount, stationary target.

To be fired from the M1917A1 tripod or M2 tripod depending upon vehicular equipment.

INSTRUCTION PRACTICE (Optional)

Range (inches)	Number rounds	Target	Ideal distribution	Time allowed
1,000	10	1,000-inch machine gun.	1 round in each separate scoring space and 1 round in first and last space of each group.	No limit.
1,000	25	1,000-inch machine gun.	1 round in each scoring space.	No limit.
1,000	50	1,000-inch machine gun.	2 rounds in each scoring space (single shot).	3 minutes.

PRELIMINARY PRACTICE

Range (inches)	Number rounds	Target	Ideal distribution	Time allowed
1,000	50	1,000-inch machine gun.	2 rounds in each scoring space (single shot).	3 minutes.

RECORD PRACTICE

Repeat the preliminary practice under record firing conditions.

Table II. Fixed vehicular mount, stationary target.

INSTRUCTION PRACTICE (Optional)

Range (inches)	Number rounds	Target	Ideal distribution	Time allowed
1,000	5	Tank machine gun 3-inch square.	1 round in each of 5 scoring spaces.	No limit.
1,000	15	Tank machine gun 3-inch square.	Burst of 3 rounds in each of 5 scoring spaces.	No limit.
1,000	25	Tank machine gun 3-inch square.	Burst of 5 rounds in each of 5 scoring spaces.	20 seconds.

PRELIMINARY PRACTICE

Range (inches)	Number rounds	Target	Ideal distribution	Time allowed
1,000	25*	Tank machine gun 3-inch square.	Burst of 5 rounds in each of 5 scoring spaces.	20 seconds.

\*Two sighting shots are allowed before each string.

RECORD PRACTICE

Repeat the preliminary practice table under record firing conditions.

Table III. Free vehicular mount, stationary target.

INSTRUCTION PRACTICE (Optional)

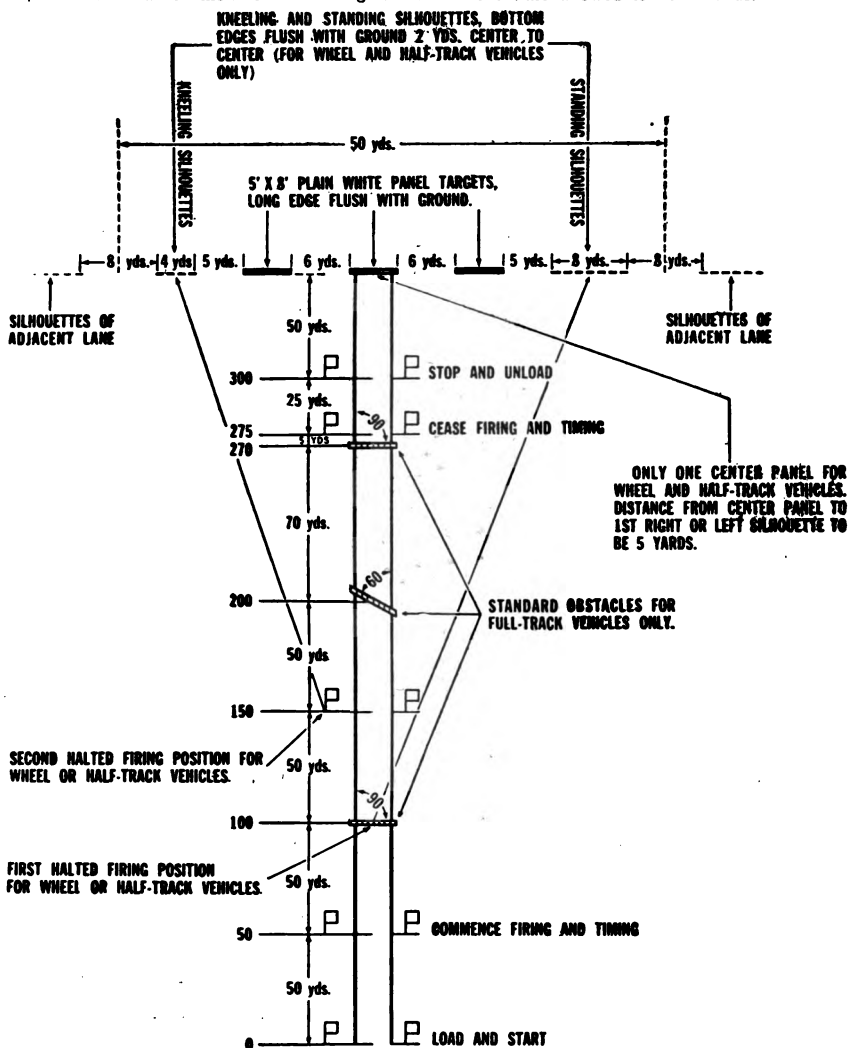
Range (inches)	Number rounds	Target	Ideal distribution	Time allowed
1,000	15	Tank machine gun 3-inch square.	Burst of 5 rounds in each of 3 scoring spaces.	No limit.
1,000	25*	Tank machine gun 3-inch square.	Burst of 5 rounds in each of 5 scoring spaces.	20 seconds.
1,000	25*	Tank machine gun 3-inch square.	Burst of 5 rounds in each of 5 scoring spaces.	20 seconds.

## PRELIMINARY PRACTICE

Range (inches)	Number rounds	Target	Ideal distribution	Time allowed†
1,000	50*	Tank machine gun 3-inch square.	Burst of 10 rounds in each of 5 scoring spaces.	20 seconds.
1,000	50*	Tank machine gun 3-inch square.	Burst of 10 rounds in each of 5 scoring spaces.	20 seconds.

\*Two sighting shots are allowed before each string.

†For a tank which mounts a 37-mm gun increase the time allowed to 28 seconds.



RUNWAY TO BE DIRT AND APPROXIMATELY LEVEL. LAST 75 YARDS  
IN FRONT OF TARGETS TO BE FREE OF ROCKS, GRAVEL OR OTHER  
SIMILAR MATERIAL.

*Figure 128. Specifications, moving vehicle range.*

Table IV. Moving vehicle, stationary target

PRELIMINARY PRACTICE

Range (yards)	Number rounds <sup>3</sup>	Target	Ideal distribution	Vehicle speed	Time allowed
250 <sup>1</sup>	50	5 standing silhouettes, to right front.	Not to exceed 9 hits on any one silhouette.	Halted	5 minutes over-all.
200 <sup>1</sup>	30	3 kneeling silhouettes, to left front.	Not to exceed 9 hits on any one silhouette.	Halted	5 minutes over-all.
200 <sup>1</sup>	20	One 5-foot by 8-foot plain light colored panel target. Long edge flush with the ground.	.....	Start from second halt position, attain, and maintain a uniform speed of 10 mph.	5 minutes over-all.
300 <sup>2</sup>	100	Three 5-foot by 8-foot plain light colored panel targets, long edges flush.	Not to exceed 35 hits on any one target.	Uniform speed of 8 mph.	No limit.

<sup>1</sup>For wheel or half-track vehicles only. No obstacles are placed in the firing lane. Over-all time from the COMMENCE FIRING point (flag) to the CEASE FIRING point (flag) not to exceed 5 minutes.

<sup>2</sup>For full track vehicles. Standard obstacles are placed in the firing lane.

<sup>3</sup>Every third round is tracer.

RECORD PRACTICE

Repeat the preliminary practice table under record firing conditions.

225. Procedure for Firing

a. GENERAL. See paragraphs 119*d* and *e*.

b. 1,000-INCH COURSE FIRED FROM M2 GROUND MOUNT (table I).

(1) The gunner takes his position at the gun with the authorized amount of ammunition, checks his gun, sets the sights so that the round will hit the upper left-hand scoring space, and indicates that he is ready to fire.

(2) When all gunners have indicated that they are ready to fire, the officer conducting the firing commands, HALF LOAD.

(3) The gunner half loads, lays on the aiming point (spotter), calls, "Up," and takes his hands off the gun.

(4) The officer conducting the firing, or his assistant, then moves each gun off the aiming point by 5 to 10 mils in deflection and elevation. He then gives STAND BY, and 5 seconds later commands, COMMENCE, followed 5 seconds thereafter by, FIRING.

(5) At the command STAND BY, the gunner places his right hand on the bolt handle, his left hand on the elevating mechanism, and his eye at the sight. At the command of execution, FIRING, the gunner completes loading, relays on the aiming point, and proceeds to fire over his target, using his left hand for manipulation and right hand for firing. He engages the scoring spaces as desired, except that the fixed target and the traversing target must be fired with sight settings which enable the gun to be laid on corresponding spotters. The searching and oblique traversing target must be engaged by laying directly on the scoring spaces.

(6) Five seconds before the end of the time allowed, the officer conducting the firing commands, CEASE. At the completion of the time allowed, he gives the command of execution, FIRING, after which no additional rounds may be fired.

(7) The officer conducting the firing will then cause the guns to be cleared and the targets to be scored.

c. 1,000-INCH COURSE FIRED FROM VEHICULAR MOUNT (tables II and III). (1) The gunner fires his sighting shots when directed to do so by the coach or assistant scorer.

(2) When the sighting shots have been fired, the coach or assistant scorer gives the command LOAD.

(3) The gunner fully loads, aims at any scoring space he desires, and signals "Ready."

(4) The coach or assistant scorer then gives or relays the command COMMENCE FIRING.

(5) The gunner commences firing and manipulates to distribute his fire in bursts on each of the five scoring spaces within the prescribed time limit.

(6) The coach or scorer gives or relays the command CEASE FIRING so that the command of execution reaches the gunner as the time limit elapses.

(7) The gunner ceases firing.

(8) The gun is unloaded.

(9) Commands COMMENCE FIRING and CEASE FIRING are

given so that there is an interval of 3 to 5 seconds between the preparatory command and the command of execution.

(10) To insure that the gunner receives the commands COMMENCE FIRING and CEASE FIRING immediately, he should be tapped at the command of execution by the coach or assistant scorer.

*d. MOVING VEHICLE FIRING* (table IV). (1) Upon the arrival of the vehicle at the starting point, the gunner gets into position and prepares to load.

(2) The coach or assistant scorer relays the commands READY and LOAD to the gunner.

(3) Upon receipt of the command LOAD, the gunner loads and assumes the firing position.

(4) When firing from a wheel or half-track vehicle—

(a) Upon arrival at the first halt, the gunner fires, distributing about 30 rounds on the five silhouettes to his right front.

(b) Upon arrival at the second halt, the gunner fires, distributing about 20 rounds on the three silhouettes to his left front.

(c) After the vehicle has started on the remainder of the course, the gunner fires the remainder of his ammunition on the center target at the end of the firing lane.

(5) When firing from a full track vehicle—

(a) Upon arrival at the commence firing flag, the coach or assistant scorer gives the command or signal COMMENCE FIRING.

(b) The gunner fires at will on the three targets located at the end of the firing lane, attempting to distribute his fire so as not to exceed 35 hits on any one target.

(6) When the vehicle passes the CEASE FIRING flag, the coach or assistant scorer signals the gunner CEASE FIRING.

(7) The gunner ceases firing immediately, and the gun is unloaded and cleared in accordance with paragraph 122*e* and *f*.

## 226. Stoppages

*a.* For a description of the procedure to be followed in eliminating stoppages, see paragraph 119*j*.

*b.* If a stoppage occurs when firing table I, the gunner will be given the remainder of his time limit to complete the exercise. The gunner will fully load, and lay on any point he desires before the command COMMENCE FIRING is given.

*c.* If a stoppage occurs when firing table II, III, or IV, the exercise is refired except that in event of a stoppage in a wheeled vehicle when

firing table IV, the gunner is permitted to refire only that part of the course which has not been fired at the time the stoppage occurred. He is then allowed the ammunition remaining in the belt plus the round which caused the stoppage.

*d.* If in record practice firing of tables II and III the gunner reduces one stoppage by pulling the bolt to the rear and releasing it, and subsequently a second stoppage occurs which the gunner believes to be the fault of the weapon, he holds up his hand and calls, TIME. The scoring officer rules on the responsibility for the stoppage as described in paragraph 119j.

*e.* Unfired rounds ejected during the reduction of stoppages which occur on the 1,000-inch range may be fired after the expiration of the time limit. Before COMMENCE FIRING is given, the gun is fully loaded and laid on any point selected by the gunner. Three seconds are allowed when firing table I and 1 second when firing table II or III for each round so ejected. During moving vehicle firing, any round so ejected is forfeited except as provided in *c* above.

## 227. Scoring

*a.* GENERAL. See paragraph 119a.

(1) *Accidental discharges.* See paragraph 119h.

(2) *Firing on wrong target.* See paragraph 119k(5).

(3) *Firing more ammunition than authorized.* The shot holes in the target are counted. If the number of holes exceeds the amount of ammunition authorized for the target, the gunner is penalized three points for each round in excess of the allowance, except that a minimum deduction of six points will be made.

(4) *Firing after command or signal to cease firing.* If the gunner fires after the command or signal CEASE FIRING, he is penalized five points and an additional point for each round fired in excess of five.

(5) *1,000-inch firing.* During 1,000-inch firing, the name of the individual is placed on his target before he fires on it. No person handles the target until after it is scored, except under the direct supervision of the scoring officer or his assistant.

(6) *Bullet hole touching line.* A bullet hole which touches the line is counted as a hit. If it is on the line between two spaces it should be counted in the space in which it will give the highest total score.

(7) *Unfired ammunition.* Ammunition not fired within the time allowance for any exercise is forfeited.

(8) *Ricochets.* Holes which have obviously been made by ricochet bullets are counted as hits. Holes made by rocks or other foreign matter are not counted.



b. 1,000-INCH TARGETS. (1) *Table I (from ground mount)*. Two points for each space hit—possible  $2 \times 25 = 50$ .

One additional point for each hit in a scoring space, not to exceed three per scoring space—possible  $2 \times 25 = 50$ .

Total possible: 100.

(2) *Table II (from vehicular mount)*. Ten points for each space hit—possible  $5 \times 10 = 50$ .

One additional point for each hit in a scoring space, not to exceed six per scoring space—possible  $5 \times 5 = 25$ .

Total possible: 75.

(3) *Table III (from vehicular mount)*. Ten points for each space hit—possible  $5 \times 10 = 50$ .

One additional point for each hit in a scoring space, not to exceed 12 in any one scoring space—possible  $5 \times 10 = 50$ .

Score: 100 for each target. Total score 200.

c. MOVING VEHICLE—STATIONARY TARGET, TABLE IV. (1) *For wheel or half-track vehicles*. Two points for 1 hit on each silhouette target and 1 point for each additional hit, not to exceed 10 points per silhouette; 20 points, 1 point per hit, per 5-foot by 8-foot panel target.

Possible score: 100 points.

(2) *For full-track vehicles*. One point for each hit, not to exceed 35 on any one 5-foot by 8-foot panel target.

Possible score: 100 points.

d. SCORE CARDS. See paragraph 119k(3). A copy of the score card is shown below.

### SCORE CARD

Browning machine gun, caliber .30, M1919A4 (mounted in combat vehicles)

Name..... Organization.....  
 A.S. No..... Place.....  
 Grade..... Date.....  
 Preliminary gunner's test completed (date).....

TABLE I  
 (Ground Mount—Stationary Target)

Spaces hit	Hits	Score	Initials

**TABLE II**  
(Fixed Vehicular Mount—Stationary Target)

Spaces hit	Hits	Score	Initials
------------	------	-------	----------

**TABLE III**  
(Free Vehicular Mount—Stationary Target)

	Spaces hit	Hits	Score	Initials
First target.....				
Second target.....				
	.....	.....	.....	.....
Total.....				

**TABLE IV**  
(Moving Vehicle—Stationary Target)

Targets hit	Silhouettes hit	Hits	Score	Initials
Silhouettes.....				
Panels.....				
		.....	.....	.....
Total.....				

Score, additional weapon.....

Total aggregate score.....

Qualification .....

Date of qualification.....

.....  
(Signature)  
Organization Commander

## APPENDIX I

### ACCESSORIES

---

#### 1. Belt Filling Machine (fig. 129)

*a. GENERAL.* There are two types of M1918 belt filling machines. The only difference between them is that the needle bar slide assembly of the earlier model (fig. 129①) has been replaced with a shuttle assembly in that of recent issue. (See fig. 129②.) Both machines are hand operated and are designed for the rapid filling of caliber .30 machine gun web belts.

*b. ADJUSTMENT.* (1) *General.* Before using the machine, insure that it is well oiled and that all screws are tight. Fasten it securely to a table or bench.

(2) *Needle type.* Insure that the needles are properly set, with each upper needle above the corresponding lower needle, and the points of each upper needle even horizontally. The points of the upper needles must be about 0.01 inch vertically above the points of the lower needles. A playing card makes a convenient gauge for regulating the distance between the upper and lower needles.

(3) *Shuttle type.* Before using, it is necessary to adjust the shuttle. To do this, insert a round in the magazine at the base of the cartridge guide, then turn the crank clockwise and advance the cartridge to the limit of the first stroke. Loosen the two large screws of the belt guide until the guide is free to slide. Adjust the shuttle so that the neck of the cartridge case rests lightly against the rear groove of the shuttle blade. Fasten the guide securely and remove the cartridge.

*c. OPERATION.* (1) *Needle type.* (a) Turn the crank clockwise until it is straight down. Release the tension spring hook from the tension spring and raise the upper feed wheel as far as it will go.

(b) Turn the belt guide cover to the right far enough to admit the belt into the belt guide. and raise the upper needle bar as far as it will go.

(c) Insert two cartridges by hand in the two loops of the belt nearest the end with the tip. Place the belt in the machine with the first cartridge resting in the top groove of the lower feed wheel, and the belt passing out at the back through the belt guide.

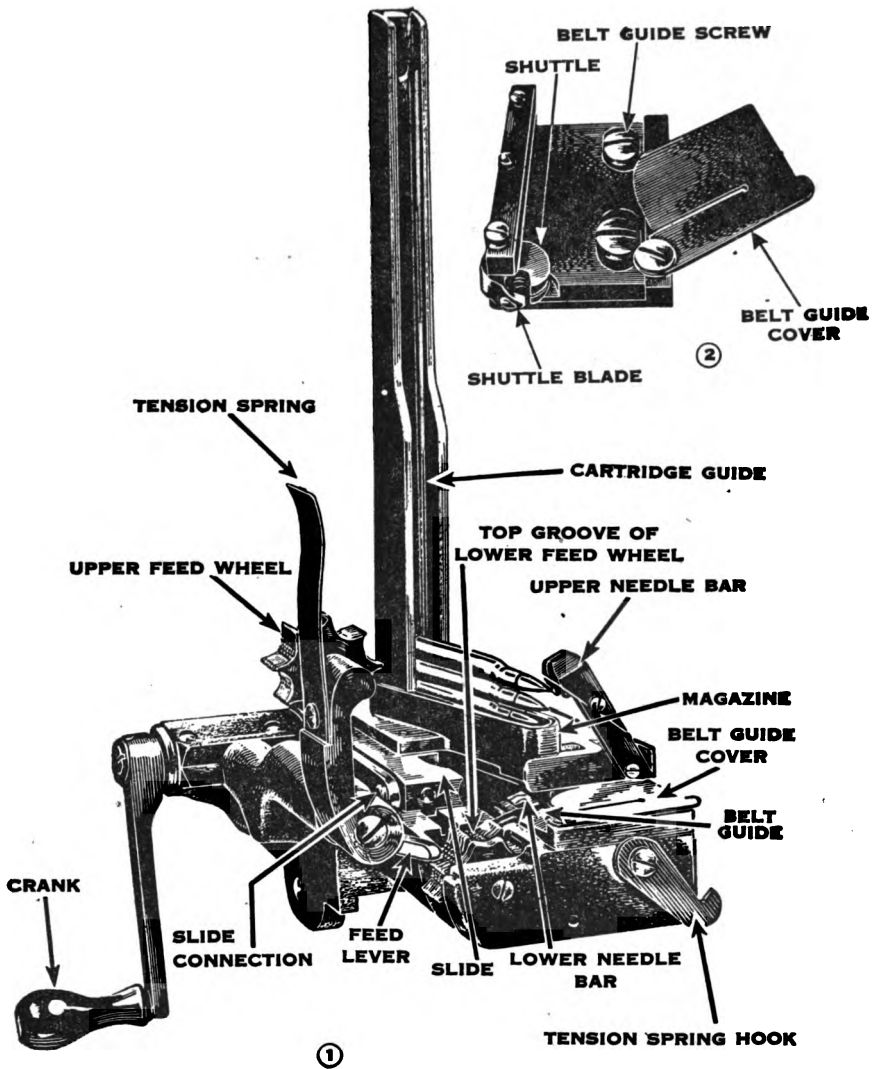


Figure 129. Belt filling machine.

(d) Return the belt guide cover to its place over the belt, being careful to see that the belt is free to pass under it, and lower the upper needle bar. Lower the upper feed wheel so that the first round in the belt fits into the bottom groove of the wheel, and secure the tension spring under the tension spring hook.

(e) Fill the cartridge guide with cartridges, with the rims engaged in the cartridge guide slots.

(f) Rotate the crank clockwise steadily and briskly. This operation will fill the belt with cartridges. Place a box ready to receive the filled belt at such a height that not more than 2 feet of filled belt will be suspended from the feed wheels of the machine.

(2) *Shuttle type.* (a) Fill the cartridge guide, then rotate the crank clockwise until the point of a bullet in the machine engages the cupped end of the groove in the back of the shuttle blade and pushes the blade point about  $\frac{1}{16}$  inch into the path of the belt.

(b) Insert a round by hand in the loop of the belt nearest the end with the tip.

(c) Turn the crank clockwise until it is straight down. Release the tension spring hook from the tension spring and raise the upper feed wheel as far as it will go. Turn the belt guide cover outward from the machine, to clear the belt path on the belt guide. Place the belt on the belt guide, with the inserted cartridge resting in the top groove of the lower feed wheel, inserting the belt between the lips of the shuttle so that the blade and the point of the second cartridge slightly enter the second loop of the belt. Rotate the belt cover fully inward so that it holds the belt in place, and proceed as in (1)(d) and (e) above.

(3) *Old type belt.* When using the old type web belt with a brass tip on each end, care must be taken to prevent the metal end from wedging into or breaking the shuttle or needles. When all except the last four or five loops of the belt have been filled, stop and swing open the belt cover. Raise the brass tip on the unfilled end of the belt and continue to rotate the crank until all except the last two loops are filled. Remove the belt and insert the last two rounds by hand.

d. MALFUNCTIONS. (1) *One or more loops in the belt are missed.* Stop, open the machine, remove the belt and tighten the slide connection. Turn the crank clockwise until it is straight down, as in starting, and replace the belt in the machine with the next to last cartridge in the top groove of the lower feed wheel. Close the machine and proceed.

(2) *Belt slides out of line when cartridges are inserted.* May be due to insufficient tension in the tension spring of the upper feed wheel. Bend the spring so as to give more tension. Serrations of the upper or lower feed wheel may be worn out. Replace the wheels.

(3) *Stoppage caused by two cartridges jammed into one loop.* Unscrew the lower feed wheel lever screw and remove the feed lever, taking care not to lose the lever spring. Examine the lever. If it is worn or broken at the neck, it must be replaced. If the malfunction continues after a new lever has been inserted, the machine should be turned over to a mechanic or to ordnance personnel for inspection and repair.

(4) *Stoppage caused by failure of feed lever to move lower, feed wheel.* Turn the machine over to a mechanic or to ordnance personnel for inspection and repair.

(5) *Cartridge jammed between shuttle and belt guide.* If cartridge cannot be removed with the aid of the point of another cartridge, turn the machine over to a mechanic or to ordnance personnel for inspection and repair.

(6) *Cartridge fails to enter loop in belt.* (a) *Needle type.* When belt fails to open, needles should be replaced.

(b) *Shuttle type.* Failure may be due to shuttle adjustment. Unscrew the two large screws on the belt guide and adjust the position of the guide until the machine functions properly. If cartridge goes over or under the loop, adjust wings of shuttle until blade is in the center. If this does not correct the failure, the shuttle must be replaced.

e. **CLEANING AND LUBRICATION OF FILLING MACHINE.** The machine should be cleaned and oiled after use. In cleaning, remove the magazine and clean the frame and all the working parts with a dry rag. Clean the upper and lower feed wheels. Particular attention should be given to cleaning the needles (or the shuttle), since the accumulation of extraneous matter in and around these parts is likely to cause a stoppage. After cleaning the machine with a dry rag, wipe with a lightly oiled rag. Prior to subsequent use, the slide should be wiped free of oil to prevent its transfer to the primers of the cartridges. Oil the crank shaft through the oil hole provided in the upper frame cap. For transportation or storage, use the belt filling machine packing chest.

## 2. Caliber .22 Trainer (fig. 130)

The caliber .22 machine gun trainer permits conversion of the caliber .30 machine gun to accommodate the caliber .22 long rifle cartridge, by changing the main group assemblies. The M3 trainer (fig. 130) is pro-

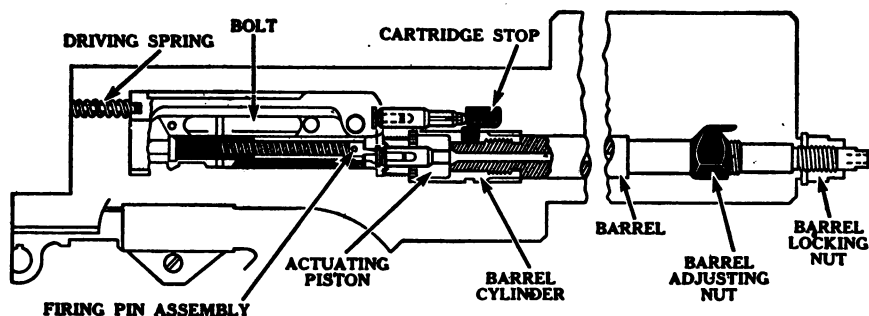


Figure 130. Caliber .22 trainer, M3.

voided for the M1917A1 machine gun, and the M4 trainer for the M1919A4. Except for a different type of barrel cylinder and the addition of a front barrel bearing, the M4 component and assemblies are identical with those of the M3 trainer.

### 3. Ammunition Box

Machine guns are provided with the metal ammunition box M1. The hinged end of the hasp on the steel box is inserted into the rectangular opening in the body of the support on the mount, permitting the sections of the support above the rectangular opening to enter the recess between the hasp and the box body. The box is forced upward until the slot in the free end of the hasp engages the projecting lug at the bottom center of the support.

### 4. Chests

a. SPARE PARTS CHEST. The authorized contents of the spare parts chest are listed in the appropriate SNL for each gun.

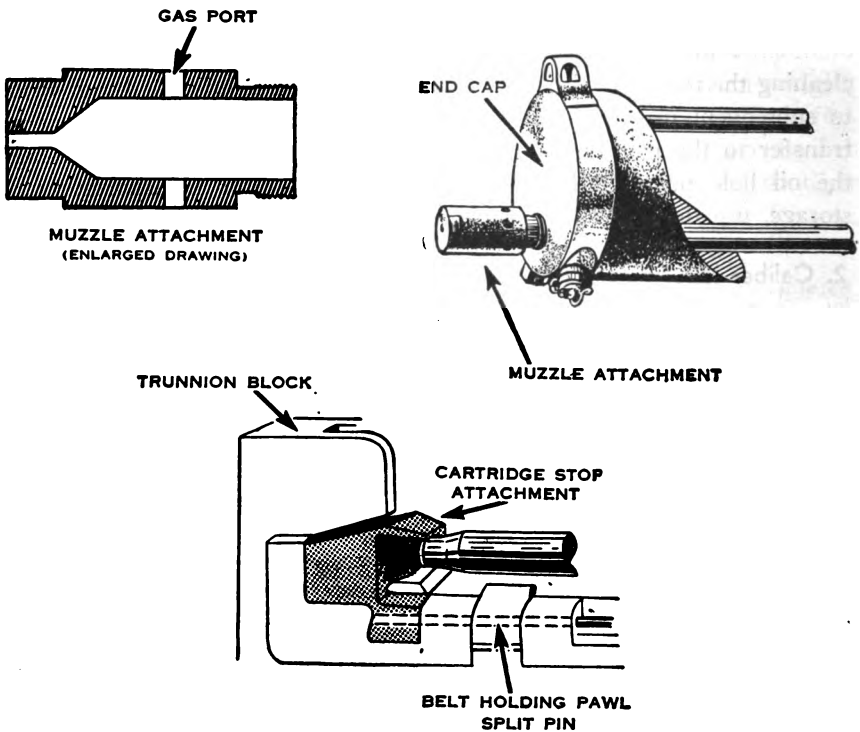


Figure 131. Blank ammunition attachments.

b. **WATER CHEST.** The M1917A1 gun is provided with the water chest M1, which holds about 1 gallon of water.

c. **BELT FILLING MACHINE PACKING CHEST.** See paragraph 1c.

## 5. Blank Ammunition Attachments (fig. 131)

a. **GENERAL.** The blank ammunition attachments are used to adapt the M1917A1 and M1919A4 guns for firing blank ammunition M1909.

(1) *Cartridge-stop attachment.* The cartridge-stop attachment is inserted by withdrawing the belt-holding pawl split pin about  $\frac{1}{2}$  inch, and sliding the attachment over the cartridge stop, lining up the small hole with the belt-holding pawl split pin and replacing this pin. The cartridge-stop attachment acts as a guide and also as a stop for the blank cartridge. Its chief use is to hold the cartridge in position in the feedway so that the extractor may engage its cannellure; it also prevents the entrance of a live round into the feedway.

(2) *Muzzle attachment for the M1917A1 machine gun.* The muzzle attachment is assembled to the gun by removing the muzzle gland and, with the packing in place, sliding the muzzle gland end of the assembled attachment over the muzzle of the barrel and screwing it into the end cap with the combination tool.

(3) *Muzzle attachment for the M1919A4 machine gun.* The attachment is assembled to the gun by removing the front barrel bearing, sliding the threaded end of the attachment over the barrel, and screwing it into the barrel jacket.

b. **PRECAUTIONS.** (1) *Never* attempt to use the muzzle attachment unless the cartridge-stop attachment is in its proper place in the feedway.

(2) Always remove the muzzle attachment before removing the cartridge-stop attachment in order to eliminate the possibility of firing ball ammunition with the muzzle attachment still in position.

(3) See that the muzzle attachment is cleaned inside before using.

(4) After firing blank ammunition, clean the barrel and muzzle attachment. *It is absolutely essential that this be done before firing any other type of ammunition.*

## 6. Antiaircraft Elevator Mount for M1917A1 Machine Gun

a. **GENERAL.** An antiaircraft elevator mount is issued to infantry and engineer units for the purpose of raising the gun to facilitate the delivery of antiaircraft fire.

b. **DESCRIPTION.** The elevator mount (fig. 74) consists of a steel tube, weight 12.25 pounds, over-all length 31 inches, with a pintle at one end and a socket at the other. A clamp locking handle is provided at the



socket end. In use, the mount lifts the gun approximately 25 inches from its ground position.

## **7. Pack Equipment**

- a. Special pack equipment for use with the M1917A1 gun consists of—
  - Tripod hanger.
  - Gun hanger.
  - Ammunition hanger.
  - Accessory and spare parts roll.
  - Spare parts bag.
  - Canvas cover for barrel.
  - Canvas case for steam-condensing device.
- b. Special pack equipment for use with the M1919A4 or the M1919A6 gun consists of—
  - Accessory and spare parts chest, M1.
  - Machine gun cover, M2.
  - Muzzle cover.
  - Ammunition cover, M2.
- c. The hangers are made of light duralumin and steel and fit the standard Phillips cavalry pack saddle.

## **8. Packboards**

Plywood packboards are provided for carrying both light and heavy machine guns. Each packboard is equipped with two universal attachments and two quick release straps.

a. **HEAVY MACHINE GUN.** The heavy gun may be carried in two loads. One method of packing is shown in figures 132 and 133.

b. **LIGHT MACHINE GUNS.** One method of packing the light gun is shown in figure 134.

## **9. Asbestos Mittens**

Asbestos mittens are issued for use with machine guns to facilitate the handling of the gun when hot, particularly when moving to a new position by hand, and when changing barrels.

## **10. Flash Hider**

The flash hider M23, issued with the M1917A1 machine gun, consists of two concentric hollow cylinders of heavy metal, each with numerous small perforations. Both cylinders are attached to a common base, the other ends being open. To attach the flash hider to the gun, remove the muzzle gland and in its place screw in the threaded projection of the flash hider base.

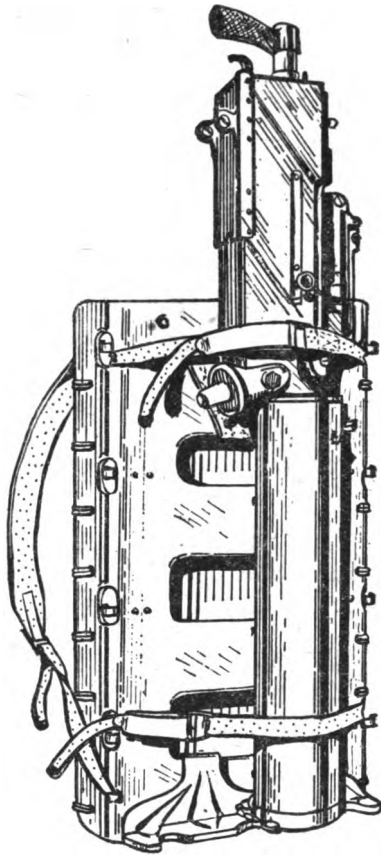
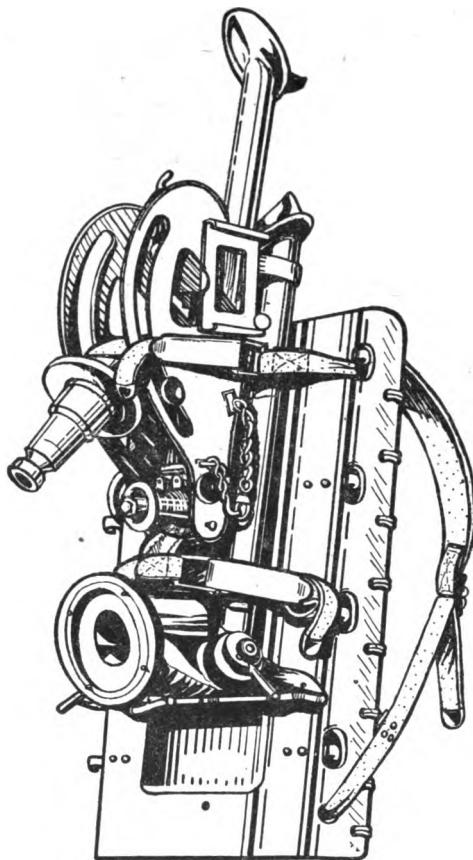


Figure 132. Heavy machine gun, mounted on packboard.

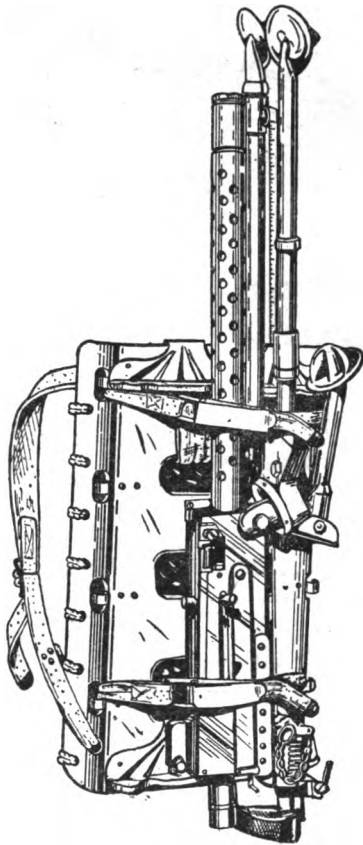
## 11. Carrying Handles (fig. 135)

*a.* GENERAL. Two types of carrying handles have been developed to increase the ease of carrying the M1917A1, M1919A4, and M1919A6 machine guns in the field. They are especially useful for carrying the guns when the barrels are hot. Both handles are generally similar in design, having a collar for attachment to the gun, a projecting elbow, and a wooden hand grip. They can be rotated to the right or left to clear the line of sighting.

*b.* HEAVY MACHINE GUN. The carrying handle for this gun (fig. 135①) weighs 1 pound. It is attached to the gun by means of a clamping collar that fits around the receiver end of the water jacket. Two flanges on this collar rest against the end of the water jacket and prevent the collar from slipping forward. The shoulder of the receiver

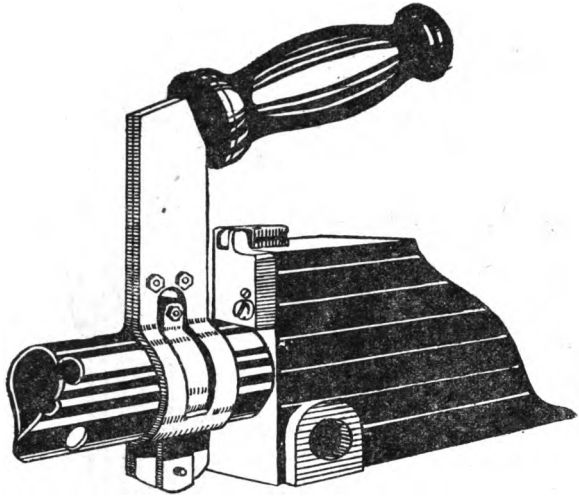


*Figure 133. M1917A1 tripod mounted on packboard.*

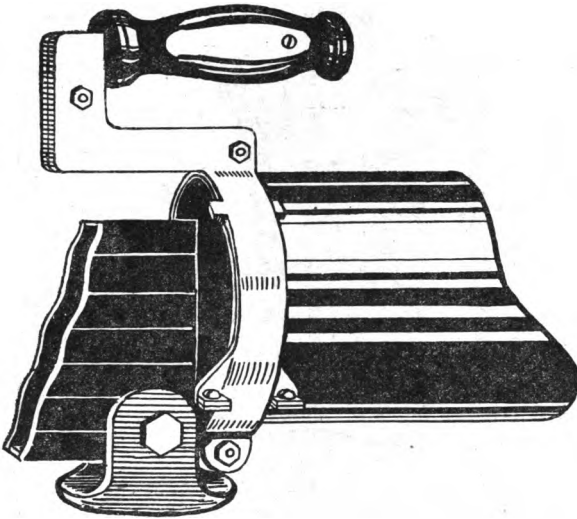


*Figure 134. Light machine gun and tripod mounted on packboard.*

①



②



① For M1919A4 and M1919A6 guns.

② For M1917A1 gun.

Figure 135. Carrying handles.

prevents the collar from sliding to the rear. A wing bolt holds the ends of the collar together.

c. LIGHT MACHINE GUNS. The carrying handle (fig. 135②) fits both guns. It weighs 1.3 pounds. The stationary inner collar is fastened around the barrel jacket against the receiver. The outer clamp collar is an integral part of the handle, and is fitted over the inner collar. The wooden hand grip is set at 15° to the axis of the gun.

## APPENDIX II

### CONSTRUCTION OF WOODEN WORKING MODEL

Figures 136 to 151 give plans for constructing a wooden working model of the machine gun as an aid to instruction in functioning.

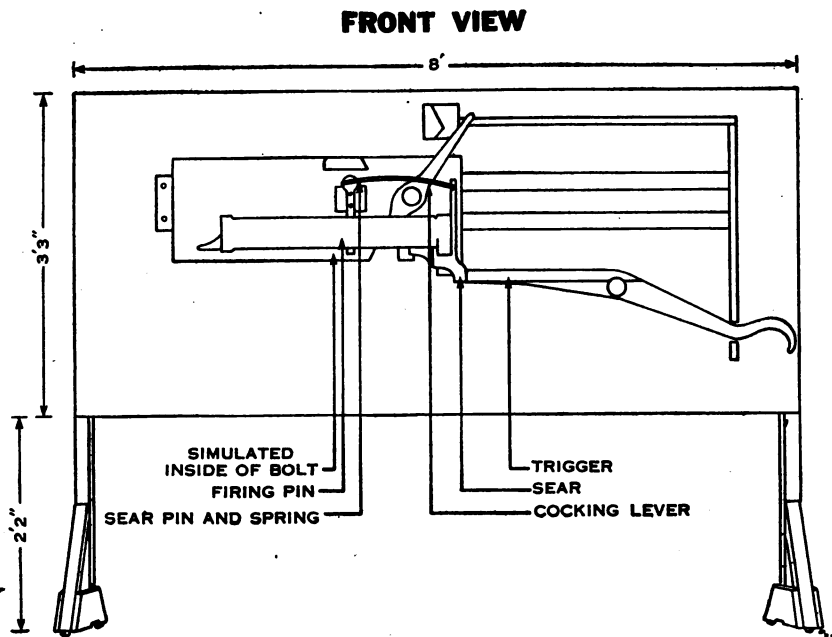


Figure 136. *Wooden working model of firing mechanism to demonstrate trigger action, cocking, and automatic fire.*

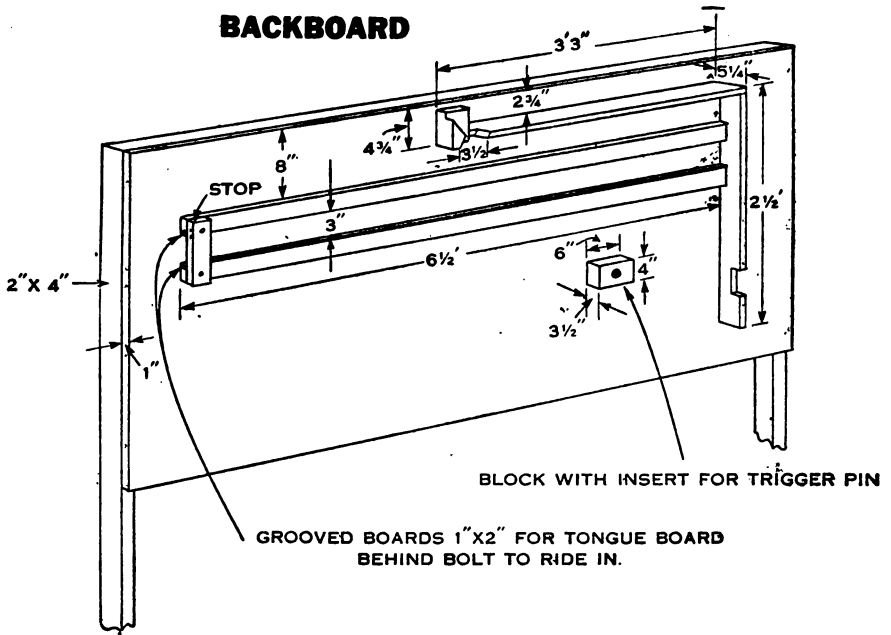


Figure 137. Construction of backboard for trigger action.

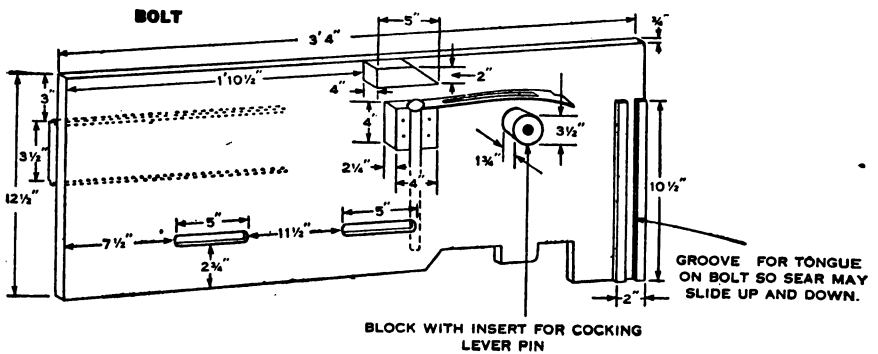
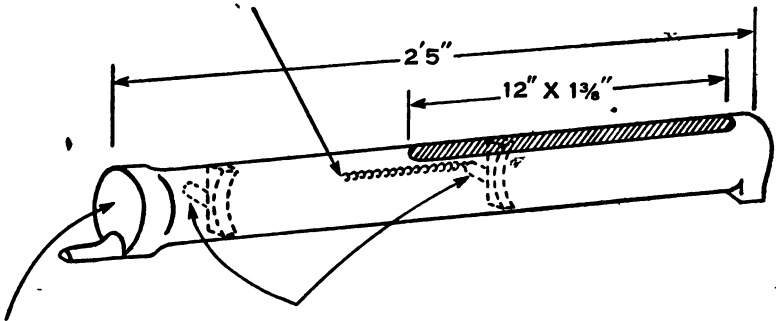


Figure 138. Construction of bolt.

## FIRING PIN

SPRING IS ATTACHED BEHIND BOLT AND ACTS AS FIRING PIN SPRING TO SEND FIRING PIN FORWARD AFTER ITS RELEASE FROM SEAR NOTCH.

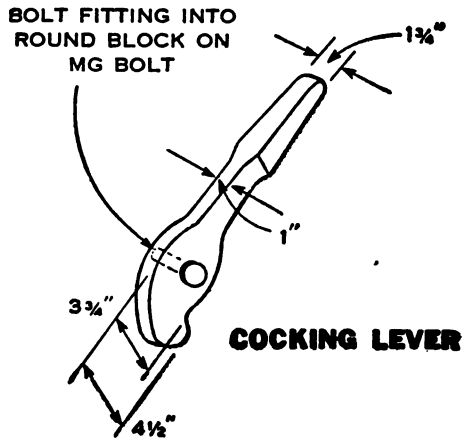


DIAMETER  $3\frac{3}{8}$ "

PEGS EXTEND THROUGH SLOTS IN BOLT

SOLID WOOD WITH EXCEPTION OF CUT-OUT SLOT WHICH EXTENDS THROUGH FIRING PIN.

*Figure 139. Construction of firing pin.*



*Figure 140. Construction of cocking lever.*



## SEAR SPRING AND PIN

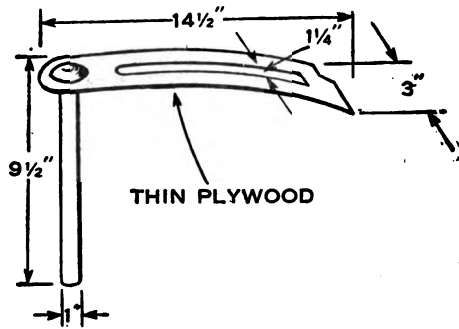


Figure 141. Construction of sear spring and pin.

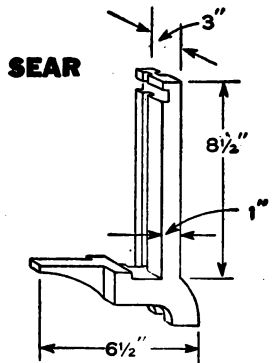


Figure 142. Construction of the sear.

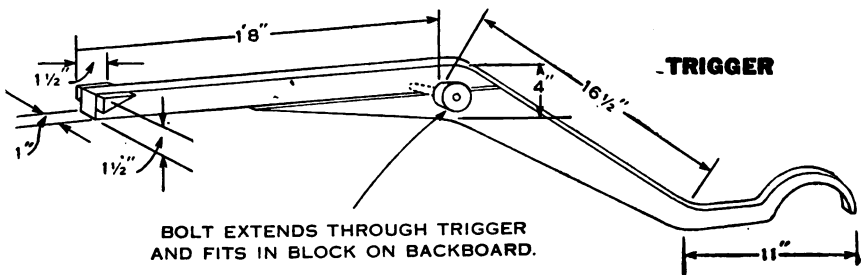
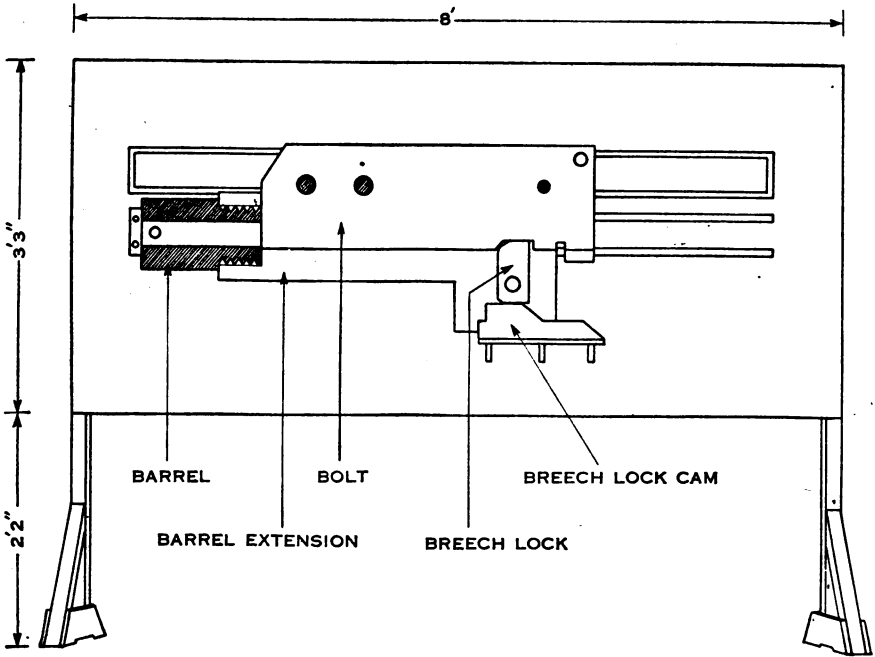


Figure 143. Construction of the trigger.

**FRONT VIEW**



*Figure 144. Wooden working model of recoiling parts to demonstrate head space adjustment, locking, and unlocking of the breech.*

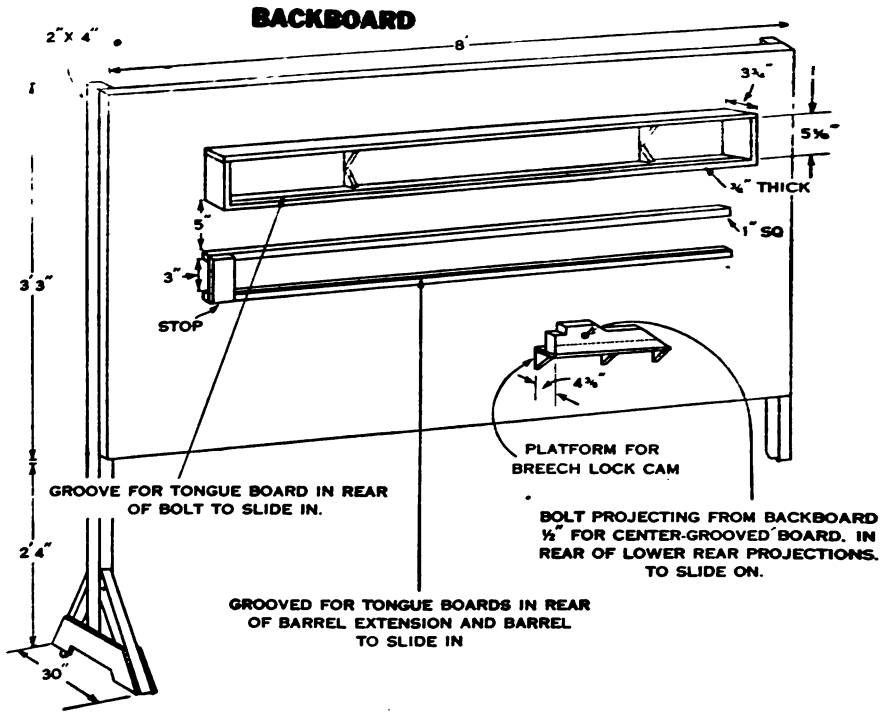


Figure 145. Construction of backboard for recoiling parts.

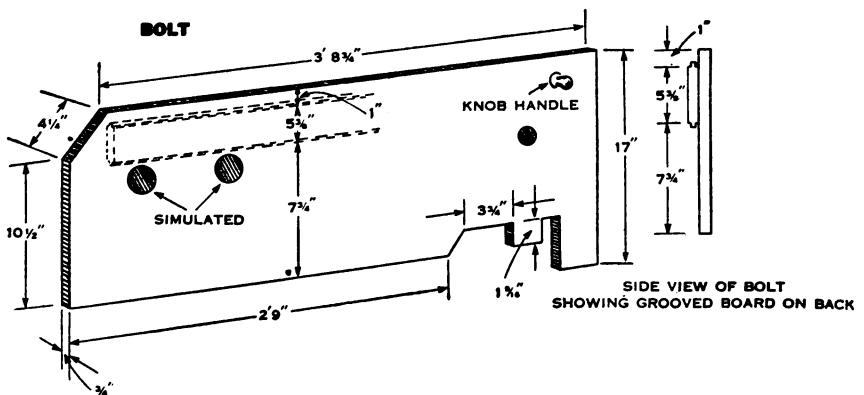


Figure 146. Construction of bolt.

## BARREL EXTENSION

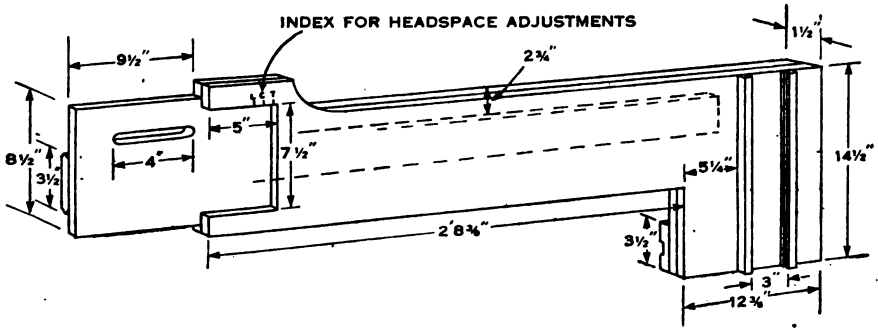
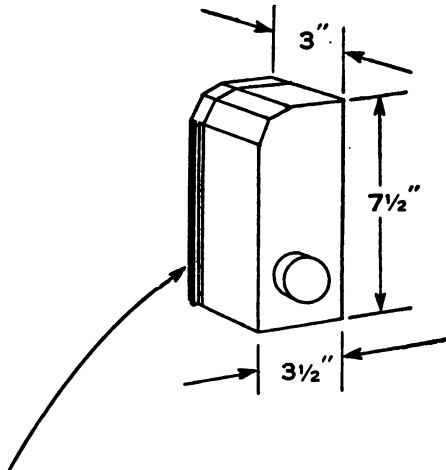


Figure 147. Construction of barrel extension.

## BREECH LOCK



BOARD WITH PROJECTIONS TO  
RIDE IN GROOVES AT REAR OF  
BARREL EXTENSION

Figure 148. Construction of breech lock.

## BREECH LOCK CAM

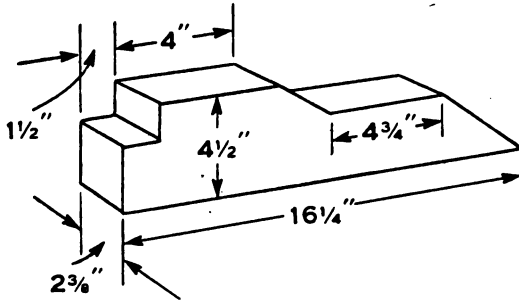


Figure 149. Construction of breech lock cam.

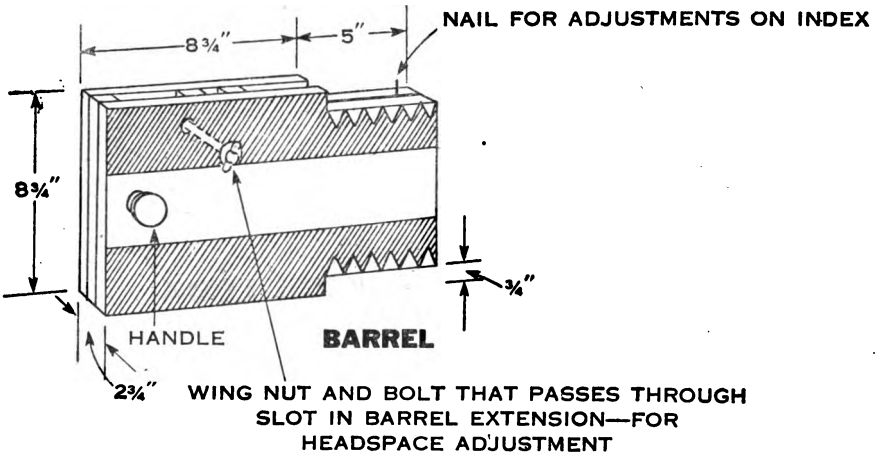
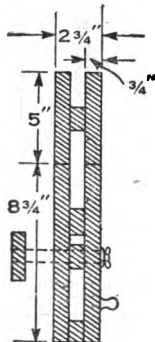


Figure 150. Construction of barrel (side view).



TOP VIEW OF BARREL

Figure 151. Construction of barrel (top view).

## APPENDIX III

### FIRING AT FIELD TARGETS

---

#### 1. Purpose

Firing at field targets has a twofold purpose: to give leaders practice in control of their units under simulated battle conditions, and to give the individual soldier practice in range estimation, selection and occupation of firing positions, and the use of cover and concealment.

#### 2. Conduct of Field Firing Exercises

**a. PREPARATION.** Field firing exercises should be carefully and thoroughly prepared. Requirements should be simple, and the principles to be taught should be clearly evident. The preparation of an exercise involves the following considerations: development of a simple problem, terrain, targets, shelter for range details, safety, communication, administrative arrangements, ammunition, units of fire, and practical tests of efficiency. An exercise is completed only when a critique has been conducted by the instructor.

**b. TERRAIN.** Terrain selected for field firing must meet safety requirements. It should offer a variety of ground forms and, if possible, be unfamiliar to the unit. In the absence of other facilities, a known distance range may be used by arranging the exercises so that they begin off the range, and require the delivery of fire on the range and in a safe direction.

**c. TARGETS.** (1) It is desirable to use natural objects, mockup buildings, and discarded truck bodies as targets. A movable field target may be made by fastening E or F targets to a sled. For targets, target materials, and range construction, see TM 9-855.

(2) Targets should be located in positions that an intelligent enemy might be expected to use in actual combat. As the training progresses, targets should be placed where they become progressively less distinct to the gunner, until, when the unit is well advanced, they are invisible to the naked eye, requiring target designation and adjustment of fire by the use of binoculars.

**d. SHELTER.** Simple pits to accommodate the target operators are sufficient for this type of firing. Care should be taken to avoid altering the

natural appearance of the terrain when locating and constructing the pits.

*e. SAFETY.* (1) The officer in charge of firing is responsible for the safety of the unit. He will insure that the guns are not loaded, and that firing is not begun, before the range is clear.

(2) When targets are placed in the rear, or to one side of a pit, the likelihood of ricochets falling into the pit is minimized. In addition, the pit detail should be cautioned to keep close to the forward protecting wall, and well down below the parapet of the pit.

(3) For the general safety measures to be observed when firing live ammunition, see AR 750-10.

*f. COMMUNICATION.* The officer in charge of a field firing exercise should arrange for communication between the firing positions and the pits in order to facilitate the conduct of the exercise. This communication may consist of temporary wire lines, flags, pyrotechnics, or bugle signals.

*g. ADMINISTRATIVE ARRANGEMENTS.* Arrangements for ranges, equipment, and supplies should be made early enough to prevent any interruption in the training schedule.

*h. AMMUNITION.* For ammunition allowances for firing at field targets, see AR 775-10.

*i. TESTS FOR PROFICIENCY.* (1) Instructors should use intelligence and imagination in devising tests of proficiency, particularly in non-firing exercises. Timing individual and unit performances, with a stop watch will often be practicable. In firing exercises, targets should in all applicable cases be scored. Interest and competition can be greatly stimulated by letting gunners know the results of their marksmanship and fire distribution.

(2) In scoring, the following formula provides a means of evaluating the results:

$$V = a \times \frac{h}{s} \times T \times \frac{l}{t}$$

$V$  = score value.

$a$  = arbitrary value assigned to the particular type of target to indicate its importance in comparison with others used in the exercise.

$h$  = number of hits on the particular type of target.

$s$  = number of rounds fired in the exercise.

$T$  = number of targets of each type.

$l$  = estimated proper time.

$t$  = time used by the particular gunner or crew.

(3) During moving target firing, the number of men who can fire simultaneously on any one target can be increased by marking the bullets with different colors. When large amounts of ammunition are to be used, painting is facilitated by rolling up the belts and dipping the tips of the bullets in a shallow pan containing about  $\frac{3}{8}$  inch of the coloring material. The mixture must mark the bullets with a thin, evenly distributed, solid coating of color which will be slightly sticky after a 1-day drying period. Lithographic ink, thinned with commercially pure spirits of turpentine, is a satisfactory marking ink. The amount of ink to be mixed with 1 pint of spirits of turpentine is as follows:

Red.....	11 ounces
Orange.....	2 pounds, 3 ounces
Green.....	3 pounds, 4 ounces
Blue.....	1 pound, 8 ounces

To obtain the correct drying rate, some experimentation is usually necessary. About 1 tablespoonful of castor oil to 1 pint of ink mixture is required. The tips of the bullets should first be cleaned with turpentine to insure that the ink will adhere. After dipping the bullets of a coiled belt into the desired color mixture, the belt is placed with bullet points down on a newspaper or other absorbent material, and allowed to drain. After about 5 minutes, the belt is moved to a clean paper; it is moved again after 10 minutes; and again after about 15 minutes.

*j. CRITIQUE.* (1) The basis of good instruction in field firing is intelligent, tactful, and constructive criticism. In his critique, the instructor should commend that which was well done and call attention to that which was poorly or incorrectly done. A solution should be offered, and compared with other possible solutions. In making corrections, the instructor should avoid ridicule, sarcasm, or any remarks which might be harmful to morale or initiative, or which might lead to a dread of assuming responsibility. If possible, the critique should be conducted upon the terrain on which the exercise was held.

(2) At the completion of all exercises, the instructor should conduct a critique covering the following points:

- (a) Use of cover and concealment.
- (b) Actions of the platoon, section, and squad leaders in getting their units on the ground without delay.
- (c) Reconnaissance by the platoon, section, and squad leaders.
- (d) Orders of the platoon, section, and squad leaders.
- (e) Suitability of firing positions.
- (f) Fire action of unit (all elements of technique used in delivering fire), together with the results obtained.



# APPENDIX IV

## INFANTRY PLOTTING BOARD M10

### 1. Description

The infantry plotting board M10 consists of a rotatable, pivoted disk, of transparent plastic material, attached to a flat base. (See figs. 152 to 154.)

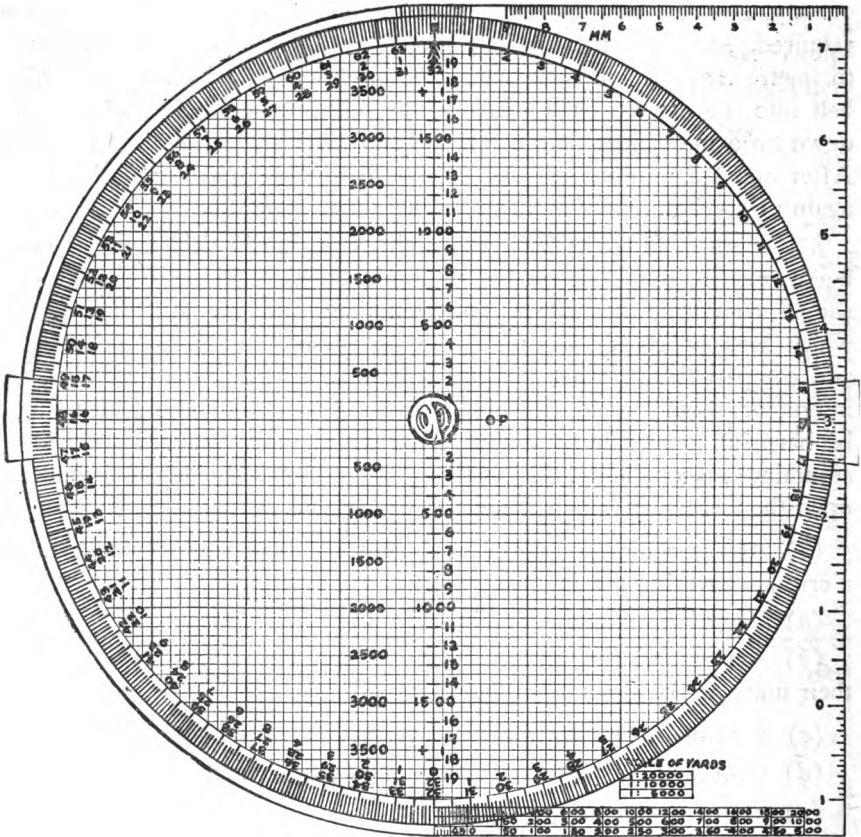


Figure 152. Infantry plotting board M10.

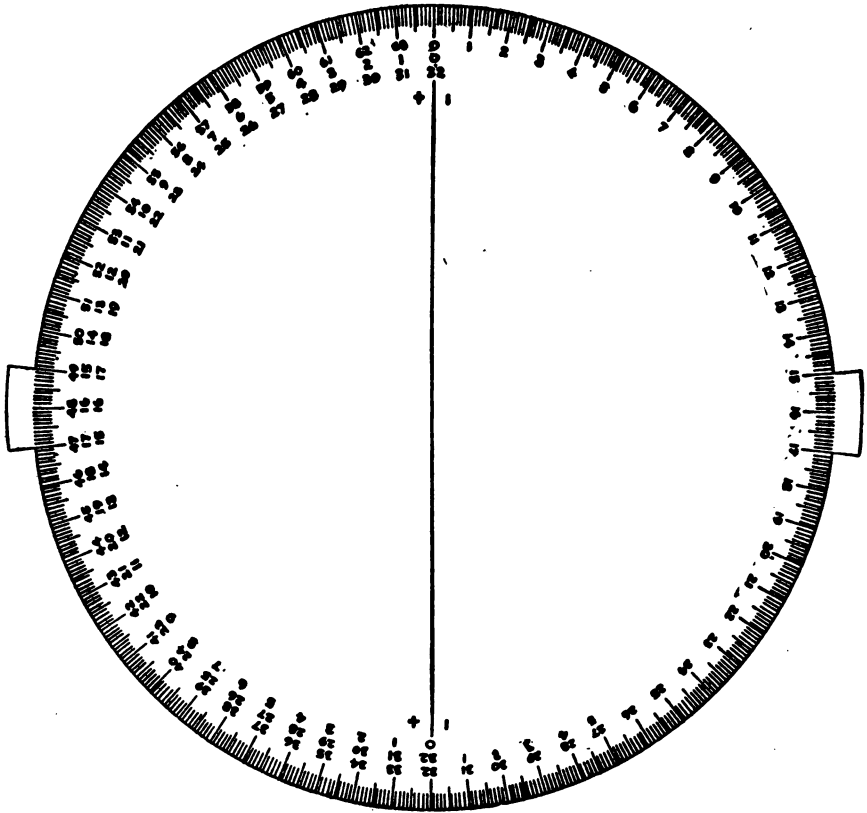


Figure 153. Top disk.

## 2. Use of Vernier Scale

a. **TO LAY OFF AN AZIMUTH.** In order to obtain greater accuracy in laying off azimuths which require interpolation between graduations of the mil scale, a vernier scale has been provided at the edge of the base opposite the right end of the index line. By means of this scale it is possible to lay off an azimuth reading with great accuracy by using the method illustrated below. For example, to lay off an azimuth of 6,263 mils:

(1) Set the graduation on the mil scale which represents 6,260 mils opposite the 0 line of the vernier scale. (See fig. 155①.)

(2) To add the final 3 mils, count, on the vernier scale, three lines to the left from the 0 line.

(3) Note the line on the mil scale which lies next inside it (toward the 0 line of the vernier scale), and rotate the top disk until the two

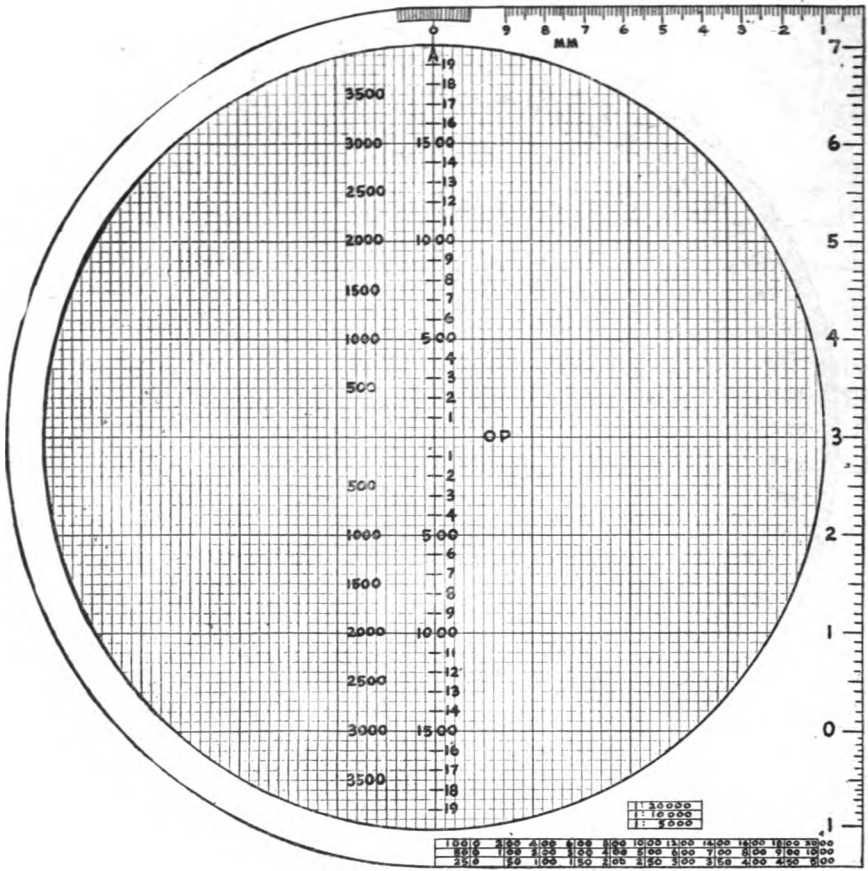


Figure 154. Base.

lines coincide. The desired azimuth is now directly opposite the pointer of the index line as shown in figure 155②.

b. To READ ACCURATELY AZIMUTH OBTAINED FROM A SETTING OF TOP DISK. Very accurate readings of an azimuth obtained by setting the top disk (as when the line G-T is aligned parallel with the index line), may be obtained by reversing the above process and proceeding as follows:

- (1) Note the number at which the pointer of the index line is set.
- (2) Note the nearest line to the left of the zero line of the vernier scale which aligns exactly with one of the 10-mil graduation lines of the top disk.
- (3) Count the number of lines from it to the zero line. This gives the number of mils in the final digit of the reading.

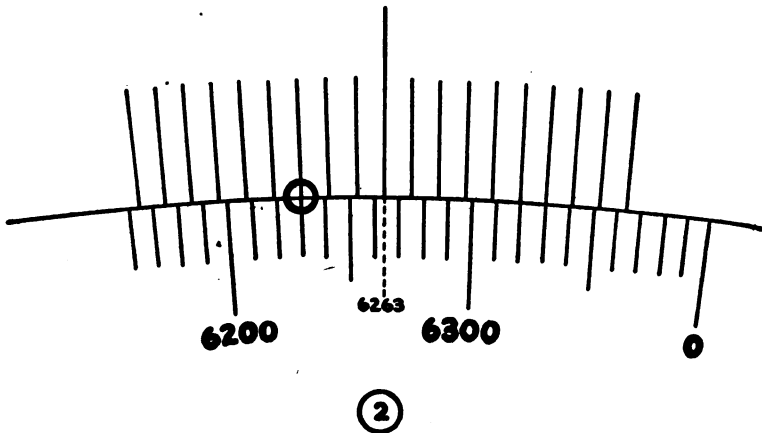
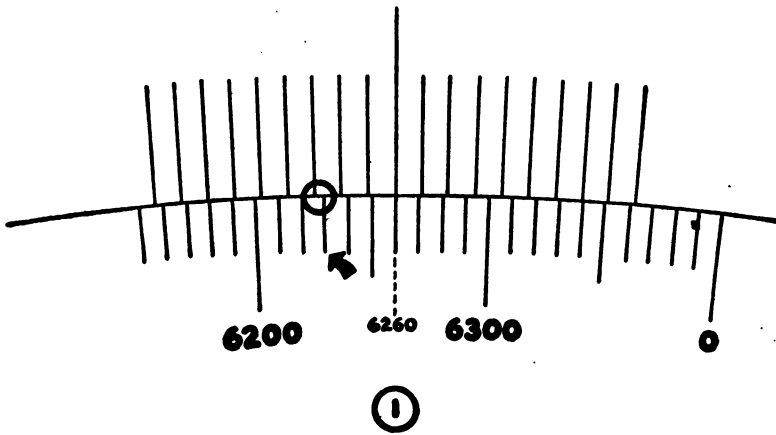


Figure 155. Example of use of vernier scale.

### 3. To Determine Horizontal Elements of Indirect Laying Data

a. To PLOT LOCATION OF TARGET. (1) *Azimuth*. Rotate the top disk until the given azimuth figure (Az. O-T), is opposite the right end of the index line.

(2) *Range*. Without moving the top disk, measure off the given range (range O-T) along the index line from the center toward the right, using the normal value of the grid squares for ranges less than 2,000 yards, or using double the value of the grid squares for ranges greater than 2,000 yards. Place a pencil mark directly on the index line at the given range. This is the plotted target location.

b. TO PLOT LOCATION OF GUN. (1) *Azimuth*. Proceed as in (1) above, using announced azimuth O-G.

(2) *Range*. Proceed as in (2) above using announced range O-G.

c. TO DETERMINE AZIMUTH AND RANGE G-T. (1) Draw a line from the pencil mark which represents the gun position to that which represents the target location. (Line G-T.)

(2) (a) If azimuth O-G is *less* than azimuth O-T, rotate the disk until base line is on the *left* side of the index line and parallel to the index line.

(b) If azimuth O-G is *greater* than azimuth O-T, rotate the disk until base line is on *right* side of the index line and parallel to the index line.

(3) Read the azimuth figure which is opposite the pointer of the index line. This is the azimuth G-T. With the machine gun, it is more desirable to work with base angles rather than with base azimuths. A base angle is obtained as follows:

(a) Secure back-azimuth O-G.

(b) Subtract back-azimuth O-G from base azimuth O-T or vice versa, depending upon which is greater.

(c) Result is base angle when OP is used as initial aiming point.

(d) Whether base angle is right or left is determined by inspection of plotting.

(4) Without moving the top disk, count the grid squares along which the line G-T extends. This will give the range G-T.

d. TO DETERMINE AZIMUTH AND RANGE O-G WHEN GUN CANNOT BE SEEN FROM OP. (1) Select a point (hereafter called point B), visible from the OP, from which it is estimated that the gun position will be visible, and take its azimuth.

(2) Proceed to point B, pacing or otherwise measuring the distance.

(3) Plot the location of point B on the plotting board by rotating the top disk to the figure on the basic scale which corresponds with the azimuth OP-point B, and laying off the distance along the index line.

(4) If the gun position is visible from point B, take its azimuth (otherwise select another point (point C) from which it is estimated that the gun position will be visible), and set the top disk at the figure which represents the azimuth point B-gun position (or point C).

(5) Pace or measure the distance to gun position (or point C), and without moving the top disk from the azimuth setting point B to gun position (or point C), plot its location by drawing a line from point B parallel to the index line, and in the direction of the index arrow. Place a dot on the top disk at the proper distance from point B. This represents the gun position (or point C).

(6) When the gun position has been plotted, rotate the top disk until the dot which represents G is directly over the index line, and read the azimuth and range O-G in the usual manner.

(7) Range O-G is the distance (on the grid) from the center to the mark which represents the gun position. For very short distances, it is best to let the grid squares represent only half of their normal value.

#### 4. Determining Vertical Elements of Indirect Laying Data

a. GENERAL. It has been found that the vertical elements of the data for indirect laying can be determined with the infantry plotting board M10 to within 1 mil of the same degree of accuracy obtained by using the WORM formula.

b. TO DETERMINE AS G-T FROM AS O-T AND O-G. (1) *To plot AS O-T.*

(a) Hold the plotting board with the index line horizontal, pointer to the right.

(b) Rotate the top disk until the reading on the basic mil scale which represents the angle of site O-T (mils, plus or minus) is opposite the right end of the index line.

(c) Reading right from center, mark off the distance O-T on the top disk directly on the index line. This gives uncorrected target location.

(2) *To plot AS O-G.* Rotate the top disk until the reading on the left side of the basic mil scale which represents the AS O-G is opposite the left end of the index line. This gives gun position.

(3) *To plot corrected target location.* (a) Zero the top disk.

(b) Draw a line parallel to the index line through the uncorrected target position. From a point on this line directly opposite the gun position, G, lay off in the direction of the uncorrected target position the previously determined range G-T and mark the point T. This is the corrected target location.

(4) *To plot AS G-T.* Rotate top disk until the second mark (gun position) and the final mark (corrected target location) are on the same side of, and equidistant from, the index line. The reading (plus or minus) which is opposite the pointer of the index line is the AS G-T.

*Note.* For angles of site of less than 30 mils, a value of 1 mil is assumed for each graduation on the mil scale. For angles in excess of 30 mils, the graduations are read as printed, that is, 10 mils each.

c. TO DETERMINE MASK CLEARANCE. This procedure can also be used in determining mask clearance by applying the range and AS, OP to mask, in the same manner as the range and AS, OP to target, and solving for AS, gun to mask. Minimum QE to clear the mask is determined and compared with QE, gun to target, to determine clearance.

## APPENDIX V

### COMPUTATION OF FIRING DATA

#### 1. Source

a. Firing tables in paragraph 2 for caliber .30 ball, M2, ammunition are extracted from Ordnance Department Firing Tables 0.30-A-4, and those in paragraph 13 for caliber .30 armor-piercing, M2, ammunition from ODFT 0.30-J-1. The illustrative examples of their use are based upon data contained in the firing tables for M2 ball ammunition.

b. These tables afford a quick reference for determining angles of elevation, mask clearance, troop safety, amount of traverse and search, and corrections in sight settings for wind and drift.

#### 2. Firing Tables for M2 Ball Ammunition

Range	Table I		Table II		Table III		Table IV	Table V	Table VI
	AE	Difference	Troop safety (Minimum AE)	Difference	Mask clearance (Minimum AE)	Difference	100 yard traverse	1 mil search	Drift right
(1) Yards	(2) Mils	(3) Mils	(4) Mils	(5) Mils	(6) Mils	(7) Mils	(8) Mils	(9) Yards	(10) Mils
100	1	1	86	42	2	1			.0
200	2	0	44	12	3	1		118	.0
300	2	1	32	5	4	1		105	.0
400	3	2	27	2	5	1		91	.1
500	5	1	25	1	6	1		77	.1
600	6	2	24	1	8	2		65	.2
700	8	2	25	2	10	2		56	.2
800	10	2	27	4	12	2		48	.2
900	12	2	31	4	14	3		40	.3
1,000	15	3	35	5	17	3	100	34	.4
1,100	18	3	40	5	20	3	92	30	.5
1,200	21	3	45	6	24	4	84	26	.6
1,300	25	4	51	7	28	4	80	24	.8
1,400	30	5	58	8	33	5	72	21	.9
1,500	35	5	66	9	38	5	68	19	1.1
1,600	40	5	75	11	44	6	64	17	1.3
1,700	47	7	86	11	50	6	60	15	1.5
1,800	53	6	97	11	57	7	56	14	1.8
1,900	61	8	111	14	65	8	56	13	2.2
2,000	69	8	126	15	74	9	52	11	2.6
2,100	79	10	144	18	85	11	48	10	3.0
2,200	89	10	165	21	96	11	48	9	3.6
2,300	101	12	190	25	109	13	44	8	4.2
2,400	114	13	218	28	123	14	44	7	5.0
2,500	128	14	252	34	139	16	40	7	5.8
2,600	144	16			157	18	40	6	6.7
2,700	162	18			178	21	40	5	
2,800	183	21			202	24	36	5	
2,900	206	23			230	28	36	4	
3,000	233	27			262	32	36		

Table VII. Correction for Drift (M2 ball).\*

Range to target (Yards)	Correction	Range to target (Yards)	Correction
100	Right 6.7 mils	1,400	Right 5.8 mils
200	Right 6.7 mils	1,500	Right 5.6 mils
300	Right 6.7 mils	1,600	Right 5.4 mils
400	Right 6.6 mils	1,700	Right 5.2 mils
500	Right 6.6 mils	1,800	Right 4.9 mils
600	Right 6.5 mils	1,900	Right 4.5 mils
700	Right 6.5 mils	2,000	Right 4.1 mils
800	Right 6.5 mils	2,100	Right 3.7 mils
900	Right 6.4 mils	2,200	Right 3.1 mils
1,000	Right 6.3 mils	2,300	Right 2.5 mils
1,100	Right 6.2 mils	2,400	Right 1.7 mils
1,200	Right 6.1 mils	2,500	Right .9 mils
1,300	Right 5.9 mils	2,600	Right .0 mils

\*This table applies only when the rear sight is set at 2,600 yards.

Table VIII. Correction for Wind (M2 ball).

A

Changes in elevation (mils) to compensate for a 10-mile wind						
Direction of wind	Range in yards					
	500	1,000	1,500	2,000	2,500	3,000
12 o'clock	0	0	+1.	+2.5	+7	+20
1 or 11 o'clock	0	0	+0.5	+2	+6	+17.5
2 or 10 o'clock	0	0	+0.5	+1	+3.5	+10
3 or 9 o'clock	0	0	0	0	0	0
4 or 8 o'clock	0	0	-0.5	-1	-3.5	-10
5 or 7 o'clock	0	0	-0.5	-2	-6	-17.5
6 o'clock	0	0	-1	-2.5	-7	-20

B

Change in windage to compensation for a 10-mile wind						
Direction of wind	Range in yards					
	500	1,000	1,500	2,000	2,500	3,000
3 o'clock	R1	R4	R7	R10	R13	R18
2 or 4 o'clock	R1	R3.5	R6	R8.5	R11.5	R15.5
1 or 5 o'clock	R0.5	R2	R3.5	R5	R6.5	R9
12 or 6 o'clock	0	0	0	0	0	0
11 or 7 o'clock	L0.5	L2	L3.5	L5	L6.5	L9
10 or 8 o'clock	L1	L3.5	L6	L8.5	L11.5	L15.5
9 o'clock	L1	L4	L7	L10	L13	L18

3. How to Use Table I. (Angle of Elevation)

Table I gives angles of elevation in mils (col. 2) for every 100 yards of range from 0 to 3,000 yards (col. 1). If ranges are not in even hundreds of yards, interpolation is necessary. For easy interpolation, the differences between angles of elevation are given in column 3 op-



posite the lines between the range figures. *Example*: Required to find the angle of elevation (AE) for 1,470 yards. *Solution*: The AE for 1,400 yards is 30 mils; for 1,500 yards, 35 mils (col. 2). The difference (col. 3) is 5 mils. Seventy yards equal 0.7 of 100 yards; hence 0.7 of 5 mils, or 3.5 mils, must be added to the AE for 1,400 yards. Thus, the AE for 1,470 yards is 30 plus 3.5 mils, or 33.5 mils. For .5 of a mil or more, an additional mil is taken, hence we use an AE of 34 mils.

#### 4. How to Use Table II (Troop Safety)

a. The range (col. 1) as used with table II is the distance in yards from the gun to the friendly troops over whose heads it is desired to fire. It is necessary to find the minimum quadrant elevation which can be fired, without danger, over the troops. The minimum QE comprises the following factors:

- (1) Safety angle (for the range from gun to troops).
- (2) AE (for the range from gun to troops).
- (3) AS (from gun to troops).

b. The *safety angle* varies with the range, and is computed so as to comprise the following factors:

- (1) The height of a man standing (2 yards).
- (2) One-half the vertical dimension of the 100 percent cone of fire at the range to the troops.
- (3) A margin of safety equal to the vertical distance which subtends a 5-mil angle at the gun, or 10 feet, whichever is greater.
- (4) A possible error of 15 percent in range.

c. The safety angle plus the AE constitutes the *minimum angle of elevation* which can be fired over the heads of troops at the given range, when troops are at the same elevation as the gun. Minimum AEs are listed in column 4 under the heading of "Troop Safety." To get the minimum QE, the minimum AE is added to the AS. *Example*: Assume the following conditions—

QE to the target .....	+48 mils
Range to friendly troops .....	1,200 yards
AS, gun to friendly troops .....	+2 mils
The minimum AE for troops at a range of 1,200 yards is .....	+45 mils (col. 4)
Add the AS .....	+2 mils
Thus, the minimum QE is .....	+47 mils

Since the QE to the target (+48 mils) exceeds the minimum QE (+47 mils), it is safe to fire.

## 5. Determining Troop Safety with Rear Sight

This procedure makes use of the *corresponding range* as derived from tables I and II. In cases where overhead fire is to be delivered and the troops are visible from the gun, the minimum AE for troop safety can be converted to a corresponding range which, when set on the rear sight, will determine troop safety. *Example*: Friendly troops are visible, and at a distance of 700 yards from the gun. The gun is laid to hit the target. Note in table II opposite the range 700 that the minimum AE for troop safety is 25 mils. Note in table I under AE (col. 2) that 25 mils is the AE for a range of 1,300 yards. Without disturbing the lay of the gun, the rear sight is set at 1,300. It is safe to fire, if the line of aim clears the feet of the troops.

*Note*. When necessary, interpolation in using tables I and II is possible, but *corresponding ranges* applied with the rear sight should be set at the next higher even hundred-yard graduation.

## 6. How to Use Table III (Mask Clearance)

The range (col. 1) used in table III is the distance in yards from the gun to the highest point of the mask. It is necessary to find the *minimum quadrant elevation* which will clear the mask. This minimum QE is one in which the lowest shot in the cone will just graze the mask, and comprises the following factors:

- Angle of clearance (for the range from gun to mask).
- AE (for the range from gun to mask).
- AS (from gun to mask).

The angle of clearance is based on the lower one-half of the vertical dimension of the cone. The angle of clearance plus the AE constitutes the minimum angle of elevation which will afford mask clearance at the given range. Minimum AEs are listed in column 6 under the heading of "Mask Clearance." To get the minimum QE, the minimum AE is added to the AS. *Example*: Assume the following conditions—

QE to the target .....	+25 mils
Range to the mask .....	1,000 yards
AS, gun to top of mask .....	+5 mils
The minimum AE for a range of 1,000 yards	+17 mils (col. 6)
Add the AS .....	+5 mils
Thus, the minimum QE is .....	+22 mils

Since the QE to the target (+25 mils) exceeds the minimum QE (+22 mils), clearance exists.

## 7. Determining Mask Clearance with Rear Sight

The procedure requires the use of the *corresponding range* as derived from tables I and III, and is similar to that employed to determine the

corresponding range for troop safety. (See par. 4.) When the mask is visible from the gun, the required mask clearance can be measured by setting the corresponding range on the rear sight. *Example*: The mask is visible and is at a distance of 700 yards from the gun. The gun is laid to hit the target. Note in table III opposite the range 700 that the minimum AE for mask clearance is 10 mils. Note in table I under AE (col. 2) that 10 mils is the AE for a range of 800 yards. Without disturbing the lay of the gun, the rear sight is set at 800. If the line of aim clears the mask, it is practicable to fire.

#### 8. How to Use Table IV (100-yard Traverse)

This table indicates the amount of traverse to be made for each 100-yard square in indirect laying. *Example*: The target is at a range of 2,200 yards and not visible from the gun. Note in column 8 opposite the range of 2,200 yards that a 48 mil traverse will be required to cover 100 yards of target width.

#### 9. How to Use Table V (1-mil Search)

This table is used to determine the number of mils search necessary to cover a target whose depth in yards is known. The data listed is the number of yards by which the center of impact will be moved (on level ground at approximately the same elevation as the gun) by a 1-mil change in elevation of the gun for the range shown. *Example*: The target is 300 yards long, and is on level ground at approximately the same elevation as the gun. The midpoint of the target is 1,100 yards from the gun. Note (in col. 9) that range of 1,100 yards, a 1-mil search will move the center of impact 30 yards. Thus, it will require 10 mils of search (the length of the target, 300 yards, divided by 30 yards, equals 10 mils) to cover the target.

#### 10. How to Use Table VI (Drift Right)

a. M1917A1 MACHINE GUN. The rifling in the bore of the gun causes the bullet in flight to drift to the right. Table VI shows the amount of drift in mils at the given ranges. The M2 rear sight on the M1917A1 gun is constructed so that, as the rear sight-leaf slide is raised, the vertical axis of its movement is cammed slightly to the left, placing an automatic correction for drift on the sight. In direct laying, therefore, using this gun, drift requires no additional compensation.

b. M1919A4 AND M1919A6 MACHINE GUNS. The sights on these guns are not constructed so as to compensate for drift automatically. Table VI indicates the amount of compensation for drift at key ranges. *Example*: Range to target is 2,000 yards. The amount of drift right for the range to the target is 2.6 mils; therefore, the axis of the bore must be moved 2.6 mils to the left. This can be done by taking 2.6 mils left windage on the windage gauge and laying on the target.

### 11. How to Use Table VII (Correction for Drift)

When indirect laying is employed with the M1917A1 machine gun, the rear sight is always set at 2,600 yards (maximum sight setting), which places on the rear sight a constant drift deflection of 6.7 mils left. When the sights with this sight setting are aligned on the IAP with zero windage, a line prolonged from the axis of the bore is 6.7 mils left of the line of aim. The same relationship exists when the gun is turned through the base angle and laid on the base stake. Therefore, it is necessary that corrections for drift at ranges other than 2,600 yards be computed and included in the windage correction. *Example:* The range to the target is 2,000 yards. The gun is laid on the IAP with zero windage and maximum sight setting. The axis of the bore is now 6.7 mils left of the line of aim. Table VI shows that the bullet will drift right 2.6 mils at 2,000 yards. In order to place the center of impact on the target, a correction of the difference between 6.7 and 2.6 mils or 4.1 mils, must be set on the windage scale and the gun relaid on the IAP. To cause the axis of the bore to point 4.1 mils to the left of the IAP when the gun is laid on the IAP, the windage scale on the rear sight is set 4.1 *right*. It is to be noted that this is true for a sight setting of 2,600 yards only. The corrections for the various ranges, using caliber .30 ball ammunition M2; are given in table VII.

### 12. How to Use Table VIII (Correction for Wind)

When it is windy, an additional correction is required on the windage scale. The amount by which the wind deflects the cone of fire from its normal path depends upon the force and direction of the wind and the range to the target. For a 10 mile per hour wind, the computed QE to hit the target must be corrected by the changes in elevation shown in A. The amount of windage required to correct for a 10 mile per hour wind at various directions appears in B. For a wind velocity greater or less than 10 miles per hour, the corrections in A and B must be multiplied by the speed of the wind expressed in tenths (ratio number).

*Example:* Assume the following conditions:

Range to target.....	2,500 yards
QE.....	+70 mils
Wind.....	7 mph from 10 o'clock

A 10 mile wind from 10 o'clock requires 11.5 mils left windage and an added elevation of 3.5 mils for a range of 2,500 yards. Thus, a 7 mile wind requires 8 mils left windage ( $.7 \times 11.5$  equals 8.05, or 8 mils) and an added elevation of 2.5 ( $.7 \times 3.5$  equals 2.45, or 2.5 mils), giving a final QE of 72.5, or 73 mils. The correction for drift is added or subtracted from the windage as determined above and the result then set on the windage gauge.

### 13. Firing Tables for M2 Armor-piercing Ammunition

a. GENERAL. The exterior ballistics of armor-piercing ammunition M2, differ only slightly from those of caliber .30 ball, having a slightly flatter trajectory than M2 ball. The following tables are extracts from Ordnance Department Firing Tables 0.30.-J-1 and are used as explained in paragraphs 1 to 12 above.

### 14. Firing Tables for M2 Armor-piercing Ammunition

Range	Table I		Table II		Table III		Table IV	Table V	Table VI
	AE	Difference	Troop safety (Minimum AE)	Difference	Mask clearance (Minimum AE)	Difference	100 yard traverse	1 mil search	Drift right
(1) Yards	(2) Mils	(3) Mils	(4) Mils	(5) Mils	(6) Mils	(7) Mils	(8) Mils	(9) Yards	(10) Mils
100	0.8	.8	86.6	-42.5	2.8	.8		125	0
200	1.6	.9	44.1	-12.0	3.6	.9		111	0
300	2.5	1.0	32.1	-5.2	4.5	1.0		100	0
400	3.5	1.2	26.9	-2.2	5.5	1.2		83	0
500	4.7	1.4	24.7	-6	6.7	1.4		71	0
600	6.1	1.6	24.1	+6	8.1	1.6		62	0
700	7.7	2.0	24.7	2.4	9.7	2.0		50	0
800	9.7	2.4	27.1	3.3	11.7	2.4		42	0
900	12.1	2.7	30.4	3.6	14.1	2.8		37	0
1,000	14.8	3.1	34.0	4.4	16.9	3.2	100	32	1
1,100	17.9	3.5	38.4	5.2	20.1	3.7	92	28	1
1,200	21.4	4.0	43.6	6.2	23.8	4.2	84	25	1
1,300	25.4	4.4	49.8	7.0	28.0	4.7	80	23	1
1,400	29.8	4.8	56.8	8.0	32.7	5.1	72	21	1
1,500	34.6	5.3	64.8	9.1	37.8	5.6	68	19	1
1,600	39.9	5.8	73.9	10.1	43.4	6.1	64	17	1
1,700	45.7	6.4	84.0	11.9	49.5	6.8	60	16	2
1,800	52.1	7.1	95.9	13.4	56.3	7.5	56	14	2
1,900	59.2	8.0	109.3	17.0	63.8	8.6	56	12.5	2
2,000	67.2	9.0	126.3	20.9	72.4	9.7	52	11	3
2,100	76.2	10.0	147.2	26.0	82.1	10.8	48	10	3
2,200	86.2	11.4	173.2	34.4	92.9	12.6	48	9	4
2,300	97.6	13.3	207.6	48.9	105.5	15.0	44	8	5
2,400	110.9	15.7	256.5	81.2	120.5	18.2	44	6	5
2,500	126.6	18.7	337.7		138.7	22.4	40	5	6
2,600	145.3	23.1			161.1	28.3	38	4	7
2,700	168.4	29.6			189.4	37.0	37	3	9
2,800	198.0	39.2			226.4	49.9	35	2.5	10
2,900	237.2	54.0			276.3	72.1	35	2	12
3,000	291.2	95.7			348.4		33	1	15
3,100	386.9								19
3,135	490.7								

Table VII. Correction for drift (M2 armor-piercing).

Range to target (Yards)	Correction	Range to target (Yards)	Correction
100	Right 6.7 mils	1,600	Right 5.7 mils
200	Right 6.7 mils	1,700	Right 4.7 mils
300	Right 6.7 mils	1,800	Right 4.7 mils
400	Right 6.7 mils	1,900	Right 4.7 mils
500	Right 6.7 mils	2,000	Right 3.7 mils
600	Right 6.7 mils	2,100	Right 3.7 mils
700	Right 6.7 mils	2,200	Right 2.7 mils
800	Right 6.7 mils	2,300	Right 1.7 mils
900	Right 6.7 mils	2,400	Right 1.7 mils
1,000	Right 6.7 mils	2,500	Right .7 mils
1,100	Right 5.7 mils	2,600	Left .3 mils
1,200	Right 5.7 mils	2,700	Left 2.3 mils
1,300	Right 5.7 mils	2,800	Left 3.3 mils
1,400	Right 5.7 mils	2,900	Left 5.3 mils
1,500	Right 5.7 mils	3,000	Left 8.3 mils

Table VIII. Corrections for Wind (M2 armor-piercing).

A

Changes in elevation (mils) to compensate for a 10-mile wind						
Direction of wind	Range in yards					
	500	1,000	1,500	2,000	2,500	3,000
12 o'clock	0	0	+1	+2	+8	+50
1 or 11 o'clock	0	0	+1	+2	+7	+43
2 or 10 o'clock	0	0	0	+1	+4	+25
3 or 9 o'clock	0	0	0	0	0	0
4 or 8 o'clock	0	0	0	-1	-4	-25
5 or 7 o'clock	0	0	-1	-2	-7	-43
6 o'clock	0	0	-1	-2	-8	-50

B

Change in windage to compensate for a 10-mile wind						
Direction of wind	Range in yards					
	500	1,000	1,500	2,000	2,500	3,000
3 o'clock	R2	R4.5	R7.5	R10	R14.5	R23.5
2 or 4 o'clock	R1.5	R4	R6.5	R8.5	R12.5	R20.5
1 or 5 o'clock	R1	R2	R4	R5	R7	R12
12 or 6 o'clock	0	0	0	0	0	0
11 or 7 o'clock	L1	L2	L4	L5	L7	L12
10 or 8 o'clock	L1.5	L4	L6.5	L8.5	L12.5	L20.5
9 o'clock	L2	L4.5	L7.5	L10	L14.5	L23.5

15. Use of Trajectory and Safety Chart (figs. 156 and 157)

The trajectory and safety chart contains the same data as the firing tables, in graphic form. From it can be determined the QE in mils

when the range and VI in yards are shown. Mask and troop clearance can also be determined. The AS and AE are not computed. The chart is more convenient to use than the firing tables, and saves time in obtaining firing data for indirect laying problems.

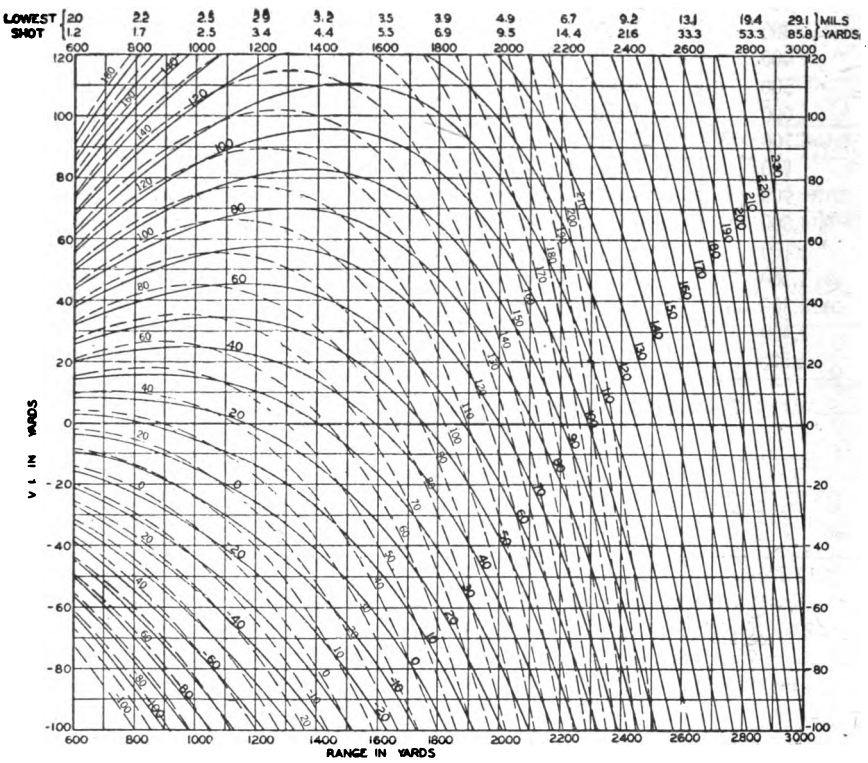
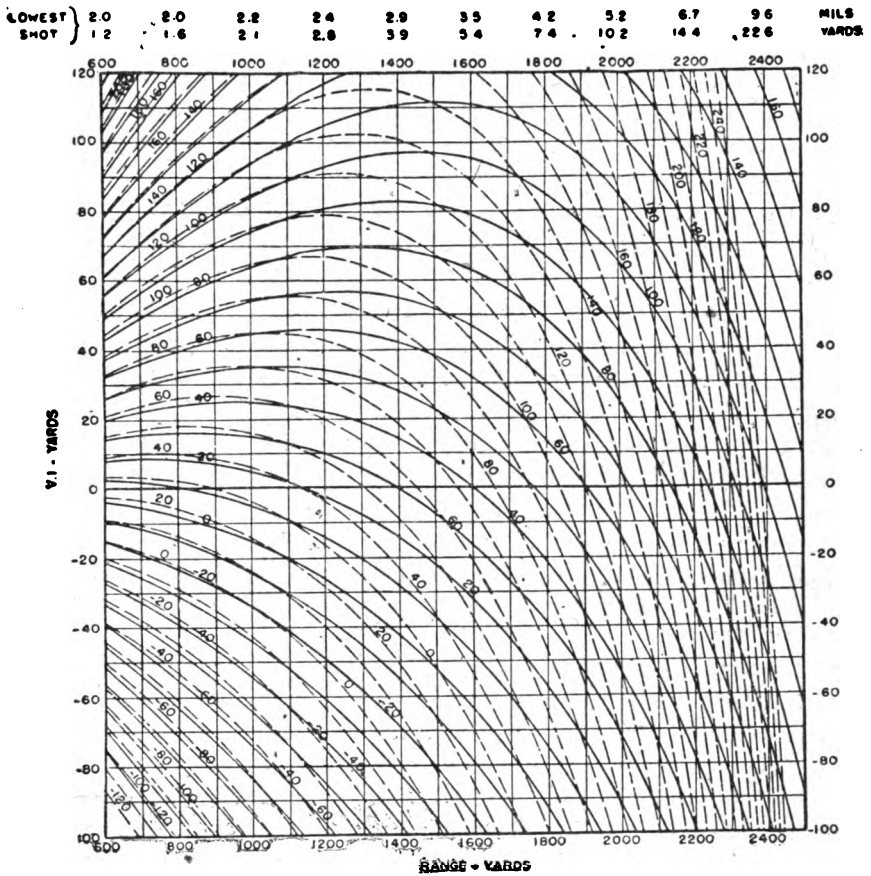


Figure 156. Trajectory and safety chart (extract) for M2 ball ammunition.

a. To DETERMINE QE. *Example:* This example is prepared for the chart in figure 156. Whenever a belt contains AP ammunition, regardless of the amount, the chart in figure 155 should be used. The range to the target is 1,650 yards. Locate the vertical lines on the chart corresponding to ranges of 1,600 and 1,700 yards. (Ranges are marked both at the top and bottom of the chart. The vertical line for 1,700 yards lies between the two lines marked "1,600" and "1,800," respectively.) Between 1,600 and 1,700 interpolate the range 1,650. This will be 0.5 of the interval between 1,600 and 1,700. Draw a vertical line through this point. The vertical interval (VI) gun-target is +16 yards; that is, 0.6 of the distance between the horizontal line indicating 10 yards and the horizontal line next above, marked 20. Draw a horizontal



*Figure 157. Trajectory and safety chart (extract)  
for M2 armor-piercing ammunition.*

line at +16 so that it intersects the vertical line drawn at a range of 1,650. Note that these two lines intersect at a point between two solid black curved lines marked "50" and "60," respectively. These black curves represent QEs. By eye, it is estimated that the point of intersection occurs at about .3 of the interval between 50 and 60, or .3 of 10 (considered as 3). Thus, the QE to hit the target is +53 mils (50 mils plus .3 of 10 mils, or 3 mils).

*b. TO DETERMINE MASK CLEARANCE. (1) Example.* The computed QE to hit the target is +53 mils, as above. Range to mask is 1,200 yards, and the vertical interval (VI) gun-mask is +22 yards. Plot the mask at a range of 1,200 and a VI of +22 as in *a* above, and read this point in relation to the solid black curves. Note that this point is on the solid black curve marked "40." Thus, the QE to hit the mask is +40. In



order to clear the mask, the gun must be raised until the lowest shot in the cone of fire passes over the mask. The amount of the angle through which the gun must be raised is shown in the first line of figures at the top of the chart. This line is marked "lowest shot" on the left, and "mils" on the right. At a range of 1,200 this angle is 2.9 mils; 3 is the nearest whole number. Hence, the QE to hit the mask must be increased by 3 mils in order for the lowest shot to clear. The minimum QE is therefore +43, and clearance exists, since the computed QE to hit the target (+53) exceeds this figure.

(2) Required clearance may be determined in yards instead of mils. The second line of figures from the top shows the vertical distance in yards between the center of the cone and the lowest shot at any given range. At a range of 1,200 yards, this distance is 3.4 yards (considered as 3 yards). Thus, in order to clear the mask, the gun must be laid to hit a point 3 yards above the top of the mask. This point is plotted at a range of 1,200 yards and a VI of 22 plus 3, or 25 yards. The QE to hit this point, as determined in (1) above, is +43 mils.

*Note.* If the computation shows that the lowest shot will fall only a small distance below the mask, it may still be practicable to fire, provided there are no friendly troops who might be endangered thereby.

**c. TO DETERMINE TROOP SAFETY.** (1) *Example.* Continuing the situation as in *a* and *b* above, friendly troops are found to be just short of the mask at a range of 1,000 yards, and at a VI from the gun of +12 yards. Plot this point as in *a* above, and read it in relation to the dashed curves. Note that this point is about .7 of the interval above the dashed curved marked "40." Thus, the minimum QE for troop safety is +47, and since the computed QE for troop safety is +47, it is safe to fire, since the computed QE to hit the target (+53) exceeds this figure.

(2) Troop safety may sometimes be determined satisfactorily by simple inspection of the data plotted on the chart. Compute the QE to hit the target and consider the solid black curve as its trajectory. Consider the dashed curves as the lowest trajectories affording safety to the troops. In order to fire safely over friendly troops with any QE, the position of the troops must be below the dashed curve which corresponds to the computed QE to the target.

*Note.* Figure 157, trajectory and safety chart for M2 armor-piercing ammunition, must be used when firing armor-piercing ammunition. The methods in using this chart are identical with those for M2 ball ammunition as explained above.

## 16. Table of Vertical Intervals

*a.* The table of vertical intervals shown in figure 158 has been prepared as an aid to instruction and as a field expedient. Given any two of the three variables, mils, range, and vertical interval, the third or unknown

variable can be determined by referring to the table. In many cases, the desired range may not be listed on the table, since range graduations are made in 50-yard intervals. By checking the vertical interval column, it will also be noted that all possible VIs are not shown. In both cases, however, the desired answer can be obtained by interpolation. *Example*: Given a range of 1,475 yards and an angle of site (AS) of plus 21 mils, it would be necessary to interpolate between the VI for 1,450 yards (30) and the VI for 1,500 yards (32) to obtain the required VI of plus 31 yards.

b. For an angle of site greater than 25 mils, for example, plus 42 mils, and a range of 1,700 yards, the required VI is obtained on the table by taking one-half of the angle of site given, or plus 21 mils, and finding the VI for that AS at 1,700 yards. The resulting answer, plus 36 yards, must then be multiplied by two to obtain the correct VI, plus 72 yards. The same principle applies for ranges over 2,150. Find the VI for one half the announced range and multiply by two.

c. It must be remembered that if the announced AS is minus, the resulting VI will also be minus. Likewise, a minus VI will give a minus AS.

**TABLE OF VERTICAL INTERVALS  
(V.I. in Yards)**

		RANGE IN YARDS																													
		700	750	800	850	900	950	1000	1050	1100	1150	1200	1250	1300	1350	1400	1450	1500	1550	1600	1650	1700	1750	1800	1850	1900	1950	2000	2050	2100	2150
ANGLE OF SITE IN MILS	1	1	1	1	1	1	1	1	1	1	1	1	1	1	1	1	1	2	2	2	2	2	2	2	2	2	2	2	2	2	
	2	1	2	2	2	2	2	2	2	2	2	2	2	2	2	2	2	3	3	3	3	3	3	3	3	3	3	3	3	3	3
	3	2	2	2	3	3	3	3	3	3	3	3	4	4	4	4	4	4	5	5	5	5	5	5	5	5	5	5	5	5	5
	4	3	3	3	3	4	4	4	4	4	4	5	5	5	5	5	5	6	6	6	6	6	6	6	6	6	6	6	6	6	6
	5	4	4	4	4	5	5	5	5	5	5	6	6	6	6	6	6	7	7	7	7	7	7	7	7	7	7	7	7	7	7
	6	4	5	5	5	5	6	6	6	6	6	7	7	7	7	7	8	8	8	8	8	8	8	8	8	8	8	8	8	8	8
	7	5	5	6	6	6	7	7	7	7	7	8	8	8	8	8	9	9	9	9	9	9	9	9	9	9	9	9	9	9	9
	8	6	6	6	7	7	7	8	8	8	8	9	9	9	9	10	10	10	10	10	10	10	10	10	10	10	10	10	10	10	10
	9	6	7	7	7	8	8	8	9	9	9	10	10	10	11	11	11	11	12	12	12	12	12	12	12	12	12	12	12	12	12
	10	7	7	8	8	8	9	9	10	10	10	11	11	11	12	12	12	12	13	13	13	13	13	13	13	13	13	13	13	13	13
	11	8	8	8	9	9	10	10	10	11	11	11	12	12	12	13	13	13	14	14	14	14	14	14	14	14	14	14	14	14	14
	12	8	9	10	10	10	11	11	11	12	12	12	13	13	13	14	14	14	15	15	15	15	15	15	15	15	15	15	15	15	15
	13	9	10	10	11	11	11	12	12	12	13	13	13	14	14	14	15	15	15	16	16	16	16	16	16	16	16	16	16	16	16
	14	10	11	11	11	12	12	12	13	13	13	14	14	14	15	15	15	16	16	16	17	17	17	17	17	17	17	17	17	17	17
	15	11	11	12	12	13	13	13	14	14	14	15	15	15	16	16	16	17	17	17	18	18	18	18	18	18	18	18	18	18	18
	16	11	12	12	13	13	14	14	15	15	15	16	16	16	17	17	17	18	18	18	19	19	19	19	19	19	19	19	19	19	19
	17	12	12	13	13	14	14	15	15	16	16	16	17	17	17	18	18	18	19	19	19	20	20	20	20	20	20	20	20	20	20
	18	13	13	14	14	15	15	16	16	16	17	17	17	18	18	18	19	19	19	20	20	20	21	21	21	21	21	21	21	21	21
	19	13	14	14	15	15	16	16	16	17	17	18	18	18	19	19	19	20	20	20	21	21	21	22	22	22	22	22	22	22	22
	20	14	15	15	16	16	17	17	18	18	18	19	19	19	20	20	20	21	21	21	22	22	22	23	23	23	23	23	23	23	23
	21	15	16	16	17	17	18	18	19	19	19	20	20	20	21	21	21	22	22	22	23	23	23	24	24	24	24	24	24	24	24
	22	15	17	17	18	18	19	19	20	20	20	21	21	21	22	22	22	23	23	23	24	24	24	25	25	25	25	25	25	25	25
	23	16	17	18	18	19	20	20	21	21	21	22	22	22	23	23	23	24	24	24	25	25	25	26	26	26	26	26	26	26	26
	24	17	18	19	20	20	21	21	22	22	22	23	23	23	24	24	24	25	25	25	26	26	26	27	27	27	27	27	27	27	27
	25	18	19	20	21	21	22	22	23	23	23	24	24	24	25	25	25	26	26	26	27	27	27	28	28	28	28	28	28	28	28

Figure 158. Table of vertical intervals.

## APPENDIX VI

### DESTRUCTION OF ORDNANCE MATÉRIEL IN EVENT OF IMMINENT CAPTURE

---

#### 1. General Principles

The decision to destroy ordnance matériel to prevent its capture and use by the enemy is a command decision and will be ordered and carried out only on authority delegated by the division or higher commander.

#### 2. Principles Governing Destruction

The following are the fundamental principles to be observed in the execution of an order to destroy small arms:

*a.* The destruction must be as complete as the circumstances will permit.

*b.* Lacking time for complete destruction, the parts essential to operation of the weapon must be destroyed, beginning with those parts most difficult of duplication by the enemy.

*c.* *The same essential parts of each weapon must be destroyed to prevent the reconstruction of a complete weapon from several damaged ones.*

#### 3. Training

The training of individuals before they reach the combat zone will be such as to insure their ability to destroy quickly and adequately the weapon(s) with which they are armed in an established and uniform sequence based on the principles stated in paragraph 2. Training will not involve the actual destruction of matériel.

#### 4. Methods

*a.* GUN. Of the two methods outlined herein for the destruction of the gun, the first method is preferred.

(1) *Method No. 1.* Field strip. Use the barrel as a sledge. Raise the cover until vertical; smash the cover down toward the jacket. Deform and break the backplate; deform the T-slot. Remove the firing pin from the bolt; place the striker in the hole in the face of the bolt and break

it off by bending. Wedge the lock frame, rear end down, into the top of the receiver between the top plate and extractor cam; place the chamber end of the barrel over the lock frame front projections and break the projections off. Insert the barrel extension in the back of the receiver, allowing the T-lug to protude; knock off the T-lug by striking it with the barrel from the side. Deform and crack the receiver by striking with the barrel at the side plate corners nearest the feedway. Elapsed time required for this method:  $2\frac{1}{2}$  minutes.

(2) *Method No. 2.* Insert the bullet end of a complete round in the muzzle and bend the case slightly, distending the mouth of the case to permit pulling out the bullet. Retain sufficient powder to cover the bottom of the case to a depth of approximately  $\frac{1}{8}$  inch, and spill the remainder. Reinsert the bullet in the case, *point first*. Chamber and fire this round with the reduced charge; the bullet will stick in the bore. Insert one complete round in the chamber, and fire it with a 30-foot lanyard. Use the best available cover, as this means of destruction may be dangerous to the person destroying the weapon. Elapsed time required for this method: 2 to 3 minutes.

b. M1917A1 TRIPOD. The gun pintle is left on the tripod (by removing the pintle bolt). Use the barrel as a sledge. Strike the sides of the pintle and deform it. Knock off the traversing clamp, traversing dial clamp, and gun pintle latch lever. Deform the traversing dial. Knock off the trail leg jamming handle. Elapsed time required for this method: 3 minutes.

c. M2 TRIPOD. The gun pintle is left on the tripod (by removing pintle bolt). Use the barrel as a sledge. Strike the sides of the pintle and deform it. Deform the traversing dial. Fold the rear legs, turn mount over on head, stand on folded rear legs, knock off the traversing dial clamp and the pintle latch lever, and deform the head assembly. Deform the folded rear legs so as to prevent unfolding. Extend the elevating screw and bend it by striking with the barrel. Bend the pintle yoke. Elapsed time: 3 minutes.

d. BIPOD. Use the barrel as a sledge to smash the bipod head. Elapsed time: 1 minute.

e. SPARE PARTS. The bolt, barrel extension, and firing pins will be destroyed as in a (1) above. Other parts will be broken or deformed. Small parts will be dispersed or buried. Elapsed time: 3 minutes.

f. FIRE CONTROL EQUIPMENT. All fire control equipment is difficult to replace. *It should be the last equipment to be destroyed if there is any chance of its evacuation with personnel.* If evacuation of personnel is made, all possible items of fire control equipment should be carried. If evacuation of personnel is impossible, all optical equipment, such as

range finders, aiming circles, binoculars, clinometers, and compasses will be thoroughly smashed; all firing tables, trajectory charts, and similar items will be thoroughly burned.

*g.* **DESTRUCTION OF AMMUNITION.** When time and materials are available, ammunition may be destroyed as follows: break out all packed ammunition from boxes or cartons. Stack the ammunition in a heap. Stack or pile wood, or available gasoline and oil in cans or drums, around the ammunition. Throw on the pile all available inflammable material, such as scrap wood and brush. Pour any remaining gasoline or oil over the pile. Sufficient inflammable material must be used to insure a very hot fire. Ignite the materials and take cover. Thirty to 60 minutes will be required to destroy the ammunition carried by units within the infantry regiment.

# INDEX

	<i>Paragraphs</i>	<i>Page</i>
Accessories .....	App. I	248
Action, to put gun into:		
For antiaircraft fire .....	53, 61, 68	74, 87, 96
In low position .....	52	72
In normal position .....	49, 58, 66	62, 83, 93
On a slope .....	51, 60	72, 86
Action, out of .....	50, 59, 67	62, 85, 94
Action, immediate .....	37	48
Adjustment of fire .....	107, 126, 208	123, 145, 212
Aiming .....	99-104	113
Aiming point .....	87, 205, 206	104, 206, 207
Aiming point, auxiliary .....	182	183
Aiming stake .....	75, 191, 205	100, 199, 206
Ammunition:		
Ballistic data .....	App. V	276
Box .....	App. I	248
Angle:		
Base .....	88	105
Of elevation (AE) .....	206, 213, app. V	207, 217, 276
Of shift .....	89, 209	106, 213
Of site (AS) .....	206, 213	207, 217
Safety .....	185	191
Angles, measuring and laying off:		
Horizontal .....	71-74	98
Vertical .....	76-79	101
Antiaircraft elevator mount .....	53, app. I	74, 248
Antiaircraft fire:		
Course of flight .....	130	147
Drill .....	53, 61, 68	74, 87, 96
Effect .....	129	147
Leads .....	131	149
Loadings .....	130	147
Positions .....	53, 61, 68	74, 87, 96
Targets .....	128, 138, 140, 141, 145, 151	147, 155, 156, 160, 162
Technique .....	131	149
Antifreeze coolants .....	30	35
Assembly:		
Barrel extension group .....	14	22
Bolt group .....	10	18
Cover group .....	16	23

## INDEX (Cont'd)

	<i>Paragraphs</i>	<i>Page</i>
<b>Assembly—Cont'd</b>		
Lock frame group .....	12	20
Replacing groups .....	8	10
Auxiliary aiming point .....	181	182
Ballistic data .....	App. V	276
Barrel extension group .....	13, 14	22
Barrel packing .....	18	26
Barrels .....	1-3	1
Base angle .....	88	105
Base line .....	88	105
Base stake .....	75	100
Battery drill .....	82-92	103
Beaten zone .....	107, 157	123, 164
Belt filling machine .....	App. I	248
Binocular .....	182, 186	183, 192
Bipod .....	42, 63-68, app. VII	56, 90, 267
Blank ammunition attachments .....	App. I	248
Board, infantry plotting, M10 .....	App. IV	270
Bolt group .....	9, 10	16, 18
Booster cap .....	3, 7	6, 7
Burst of fire .....	155	164
Cards, range .....	194	200
Carrying handles .....	App. I	248
Center of impact .....	107, 157	123, 164
Chart, battery .....	92, 214-216	106, 220
Chest, spare parts .....	App. I	248
Chest, water .....	46, 47, 49, 50, 52, 54, app. I	58, 62, 72, 75, 248
Cleaning .....	20-30	29
Cleaning and preserving materials .....	21	29
Clearance, mask .....	207, 214, app. V	212, 220, 276
Clearance, minimum .....	185	191
Clinometer .....	70, 80, 81	97, 102, 103
Coach-and-pupil method .....	96	109
Cocking .....	33	36
Commands. ( <i>See</i> Gun drill, Battery drill, Fire orders, Task orders, Marksmanship.)		
Communication, air-ground .....	147	160
Cone of fire .....	107, 156	123, 164
Cooling system .....	1-3	1
Coolants .....	30	35
Corresponding range .....	186	192
Courses, marksmanship .....	111, 143	126, 157
Cover group .....	15, 16,	22, 23
Cyclic rate of fire .....	1-3	1

## INDEX (Cont'd)

	Paragraphs	Page
<b>Data:</b>		
Ballistic .....	App. V	276
Firing, computation of .....	App. IV, app. V	270, 276
General .....	1-3	1
Decontamination .....	29	34
Defilade .....	202-210	204
Description, general, of machine guns .....	1-3	1
Destruction of matériel .....	App. VI	288
Dial .....	70-74, 39, 40	97, 51, 52
Direct laying .....	152-201	163
<b>Disassembly:</b>		
Barrel extension group .....	13	22
Bolt group .....	9	16
Cover group .....	15	22
General .....	6	7
Lock frame group .....	11	20
Parts dismounted for repair only .....	17	24
Removal of groups .....	7	7
Drift .....	App. V	276
Drill. ( <i>See</i> Gun drill, battery drill.)		
Driving spring .....	9, 10	16, 18
Ejection .....	33	36
Elevating mechanism .....	39, 41	51, 53
Elevation, angle of (AE) .....	206, 213, app. V	207, 217, 276
Elevation, quadrant (QE) .....	80, 81, 206, 213, app. V	102, 103, 207, 217, 276
Equipment, examination of .....	47, 56, 64	58, 79, 90
Estimation of range. ( <i>See</i> Range estimation.)		
Examination of equipment .....	47, 56, 64	58, 79, 90
<b>Exercises:</b>		
Battery .....	92	106
Firing, antiaircraft .....	138	155
Position, antiaircraft .....	135	153
Preparatory marksmanship .....	97-109	110
Range firing .....	116-119	131
Tracking .....	137	155
Extraction .....	33	36
Feeding .....	33	36
Final protective line (FPL) .....	187-193, 201	196, 203
<b>Fire:</b>		
Adjustment of .....	107, 126, 181, 208	123, 145, 182, 212
Analysis .....	151	162
Application .....	181	182
Burst of .....	155	164
Characteristics .....	154-157	163
Classes .....	158-161	167
Cone of .....	107, 156	123, 164



## INDEX (Cont'd)

	Paragraphs	Page
Fire—Cont'd		
Control .....	179-181, 183	181, 185
Density of .....	212	214
Distribution of .....	173-178, 183	174, 185
Enfilade .....	159	169
Fixed .....	158, 174	167, 174
Flanking .....	159	169
Free gun .....	158	167
Frontal .....	159	169
Grazing .....	160	169
Harassing .....	211-212	214
Indirect .....	211-216	214
Interdiction .....	211-212	214
Neutralization .....	211-212	214
Opening .....	181	182
Oblique .....	159	169
Observation of .....	107	123
Orders .....	92, 144, 169, 170, 183, 184, 209, 216	106, 159, 171, 185, 186, 213, 233
Overhead .....	185-186	191
Plunging .....	160	169
Rate of .....	1-3, 181, 192	1, 182, 199
Searching .....	158, 176	167, 177
Sectors .....	188	196
Swinging traverse .....	158	167
Traversing .....	158, 175	167, 175
Traversing and searching .....	177	179
Unit .....	173, 212	174, 214
Firing:		
Antiaircraft .....	128-151	147
Automatic .....	33	36
By chart .....	92	106
Exercises .....	116-119, 138	131, 155
Field .....	127, app. III	146, 267
From defilade .....	202-210	204
Line procedure .....	142	157
Officer in charge of .....	112	128
Flash hider .....	App. I	248
Flotation of trail leg .....	86	104
Formula:		
Mil .....	213	207
WORM .....	214	220
Free gun traverse .....	123	143
Functioning. ( <i>See also</i> Automatic firing, Cocking, Ejection, Extraction, Feeding, Loading, Locking, Recoiling parts, Trigger action, Unlocking.)	31-33	36
Gas attack, action in case of .....	29	34

## INDEX (Cont'd)

	Paragraphs	Page
Groups (of gun) .....	6-8	7
Gun drill:		
Changing numbers and duties .....	45	57
Examining equipment .....	47, 56, 64	58, 79, 90
General procedure .....	44	57
Moving gun .....	54, 62, 69	75, 89, 97
Placing gun in action:		
Antiaircraft fire .....	53, 61, 68	74, 87, 96
Close combat position .....	57	81
Low position .....	52	72
Normal position .....	49, 58, 66	62, 83, 93
On a slope .....	51, 60	72, 86
Securing equipment and forming .....	46, 55, 63	58, 79, 90
Taking gun out of action .....	50, 59, 67	62, 85, 94
Gunner's test, preliminary .....	109	125
Half load .....	32	36
Head space .....	8	10
Hider, flash .....	App. I	248
Horizontal angles .....	71-74	98
Immediate action .....	37	48
Impact, center of .....	107, 157	123, 164
Indirect laying .....	211-216	214
Initial aiming point (IAP) .....	87, 214-216	104, 220
Inspection. ( <i>See Examination of equipment.</i> )		
Instruction:		
Marksmanship, methods of .....	96	109
Practice .....	117, 118	132, 135
Interval, vertical (VI) .....	214, app. V	220, 276
Laying:		
Direct .....	152-201	163
Indirect .....	211-216	214
Leads .....	123, 125, 131	143, 144, 149
Limit, troop safety .....	186	192
Line, final protective (FPL) .....	187-193, 201	196, 203
Loading .....	32, 33	36
Lock-frame group .....	11, 12	20
Locking .....	33	36
Machine, belt filling .....	App. I	248
Machine gun trainer:		
Antiaircraft, M9 .....	136	153
Caliber .22, M3 and M4 .....	App. I	248
Manipulation:		
Engaging aerial targets .....	131, 135, 136, 138	149, 153, 155
Engaging moving ground targets .....	123, 125, 126	143, 144, 145

## INDEX (Cont'd)

	<i>Paragraphs</i>	<i>Page</i>
<b>Manipulation—Cont'd</b>		
Exercises .....	105	119
Laying off and measuring angles .....	70-79	97
<b>Marksmanship:</b>		
Courses .....	111, 143, 224	126, 157, 239
<b>Equipment:</b>		
For preparatory exercises .....	98	111
For range practice .....	114	128
<b>Exercises:</b>		
Conduct of range firing .....	116	131
Observation and adjustment of fire ..	107	123
Preparatory .....	97	110
Manipulation .....	105	119
Range estimation .....	106	122
Sight setting .....	103	117
Sight setting and laying .....	104	118
Sighting and aiming .....	99-102	113
Windage correction .....	109	125
Firing tables .....	App. V	276
Method of instruction .....	96	109
Prior training .....	95	109
Range practice .....	110-111	126
Training (vehicular mounts) .....	223	143
Measurement of angles .....	70-81	97
Mechanical functioning .....	31, 33	36
Mechanical training .....	1-43	1
Mil formula .....	213	217
Mittens, asbestos .....	57, app. I	81, 248
Model, wooden working .....	App. II	259
Mounts .....	38-42, 217-219, app. I	50, 237, 248
 <b>Nomenclature:</b>		
Guns, external .....	1-3	1
Mounts .....	38-43	50
Sights .....	1, 2	1, 4
Groups .....	7-17, 33	7, 36
 Observation of fire .....	107	123
Officer, range .....	113	128
Officer in charge of firing .....	112, 225	128, 242
Operation, principles of .....	1-3, 33	1, 36
Orders. ( <i>See</i> Fire orders, Task orders.)		
Ordinate, maximum .....	154, app. V	163, 276
 Pack equipment .....	App. I	248
Packing barrel. ( <i>See</i> Barrel packing.)		
Panels, air-ground communication .....	147	160
Partial defilade .....	202	204

## INDEX (Cont'd)

	<i>Paragraphs</i>	<i>Page</i>
<b>Parts:</b>		
Changing .....	19	27
Dismounting for repair only .....	17	24
Interchangeability of .....	19	27
Spare .....	19	27
Pintle .....	43	56
Plotting board, infantry M10 .....	App. IV	270
Position, defilade .....	202-210	204
Positions, firing .....	202, 203	204, 205
Positions, gunner's .....	48, 53, 57, 61, 65, 68, 124, 134	61, 74, 81, 92, 96, 144, 153
Preparatory exercises. ( <i>See Exercises, Marksmanship.</i> )		
Quadrant elevation (QE) .....	80, 81, 206, app. V	102, 103, 207, 276
<b>Range:</b>		
Cards .....	194	200
Corresponding .....	186	192
Determination .....	162-167	170
Effective .....	125	144
Estimation .....	106, 131, 134	122, 149, 153
Extreme usable .....	163	170
Finder .....	166, 214	171, 220
Landscape target .....	199	202
Moving vehicle .....	224	239
Officer .....	113	128
Practice .....	110-122	126
Towed target .....	145	160
Rate of fire .....	1-3, 181, 192	1, 182, 199
Recoiling parts .....	33	58
Record practice .....	119	136
Reverse slopes .....	202, 212	204, 214
Rule, gunner's .....	186	192
Rule, leader's .....	186	192
Safety angle .....	185	191
Safety limit .....	186, app. V	192, 276
Safety precautions .....	121, 122, 148	142, 161
Scoring .....	119, 150	196, 162
Sectors of fire .....	188	196
Shock absorbing group .....	17	24
Shoulder stock .....	7	7
Sighting and aiming .....	99-104	113
Sights .....	1-3, 220, 221	1, 238
Signals, air-ground communication .....	147	160
Site, angle of .....	206, 213	207
Slope, effect of .....	157	164
Slope, reverse .....	202, 212	204, 214

## INDEX (Cont'd)

	<i>Paragraphs</i>	<i>Page</i>
Spare parts .....	19	27
Stakes .....	75, 191	100, 199
Steam tube assembly .....	17	23
Stoppages .....	34-37, 119	45, 136
Storage .....	26, 27	32
Strike, fire adjustment by .....	197, 181	123, 182
 Tables:		
Drift .....	App. V	276
Fire control .....	App. V	276
Windage correction .....	108, app. V	124, 276
Target designation .....	171, 172, 183	172, 185
 Targets:		
Aerial .....	128, 133, 138, 140, 141, 143, 145-151	147, 152, 155, 156, 157, 160
Area .....	178	180
Balloon .....	138	155
Combat .....	128	147
Deep .....	176	177
Field .....	App. III	267
Landscape .....	195-201	202
Moving ground .....	123-127	143
Oblique .....	177	179
1,000-inch .....	105, 120	119
Point .....	174	174
Radio-controlled .....	140, 141	156
Towed .....	140, 141	156
Wide .....	175	175
Task orders .....	92, 216	106, 233
 Technique of fire:		
Aerial targets .....	131	149
Direct laying .....	152-201	162
Indirect laying .....	202-216	204
Moving ground targets .....	127	146
Terrain, influence on FPL .....	189	197
Test, preliminary gunner's .....	109	125
TOG method .....	213	217
Tracer control .....	123	143
Tracers, fire adjustment by .....	107, 131, 181	123, 149, 182
Trainer, antiaircraft machine gun M9 .....	136	153
Trainer, caliber .22, M3 and M4 .....	App. I	248
Trajectory .....	154, app. V	163, 276
Traverse .....	41, 158	53, 167
Traverse, free gun .....	123, 158	143, 167
Traverse, swinging .....	123, 158	143, 167
Traversing and searching exercises .....	105	119
Traversing mechanism .....	39-41	51

## INDEX (Cont'd)

	<i>Paragraphs</i>	<i>Page</i>
Trigger action .....	33	36
Tripod .....	38-41	50
Unit of fire .....	173	174
Unlocking .....	33	36
Vertical angles .....	76-79	101
Vertical interval (VI) .....	214, app. V	220, 276
Windage corrections .....	108, app. V	124, 276
Work sheets .....	214	220
WORM formula .....	213	217
Zero line .....	188	196
Zeroing gun .....	115, 198	128, 202
Zone, beaten .....	107, 157	120, 164
Zone, troop safety .....	186, 213	192, 217